



STORM WATER BMP GUIDE FOR NEW AND REDEVELOPMENT

for the City and County of Honolulu
Permit No. HI S000002

July 2017

Prepared by
City and County of Honolulu,
Department of Planning and Permitting



This page is intentionally left blank.

Table of Contents

TABLE OF CONTENTS	i
LIST OF TABLES	v
LIST OF FIGURES	vii
LIST OF APPENDICES	ix
LIST OF ACRONYMS AND ABBREVIATIONS	xi
GLOSSARY.....	xiii
ACKNOWLEDGEMENTS	xix
1. INTRODUCTION	1-1
1.1. Purpose and Scope	1-1
1.2. Users of the Manual.....	1-1
1.3. Organization of the Manual	1-2
1.4. Low Impact Development and Storm Water Quality	1-2
1.5. Regulatory Requirements	1-6
1.5.1. Federal Programs.....	1-6
1.5.2. State Programs	1-6
1.5.3. Other Relevant Regulatory Programs	1-7
1.5.4. Total Maximum Daily Loads	1-7
1.5.5. Endangered Species Act	1-7
1.5.6. Clean Water Act Section 404 Dredge and Fill Permits.....	1-7
1.5.7. Clean Water Act Section 401 Water Quality Certification.....	1-8
2. APPLICATION OF PERMANENT BMP REQUIREMENTS IN THE CITY AND COUNTY OF HONOLULU	2-1
2.1. City and County of Honolulu Plan Review Requirements	2-3
2.1.1. Storm Water Quality Strategic Plans	2-3
2.1.2. Storm Water Quality Reports	2-3
2.1.3. Storm Water Quality Checklists	2-4
2.1.4. Operations and Maintenance Plan.....	2-5
2.1.5. BMP Certification and Recording.....	2-5
2.1.6. Variances	2-6

3.	STORM WATER QUALITY PLANNING FOR NEW DEVELOPMENT AND REDEVELOPMENT	3-1
3.1.	Assess Site Conditions.....	3-2
	3.1.1. <i>Understand Hydrologic Conditions of Concern</i>	3-2
3.2.	Site Design Strategies.....	3-4
	3.2.1. <i>Conserve Natural Areas, Soils, and Vegetation</i>	3-4
	3.2.2. <i>Minimize Disturbances to Natural Drainages</i>	3-4
	3.2.3. <i>Minimize Soil Compaction</i>	3-5
	3.2.4. <i>Direct Runoff to Landscape Areas and Reduce Directly Connected Impervious Areas</i>	3-5
	3.2.5. <i>Minimize Impervious Surfaces</i>	3-6
3.3.	Control Sources of Pollutants	3-10
3.4.	Treat Runoff.....	3-12
4.	SITE AND FACILITY DESIGN FOR WATER QUALITY PROTECTION.....	4-1
4.1.	Infiltration	4-1
4.2.	Retention and Detention	4-3
4.3.	Biofilters	4-4
4.4.	Street Design.....	4-5
4.5.	Street Trees	4-7
4.6.	Parking Lots.....	4-7
	4.6.1. <i>Hybrid Parking Lots</i>	4-7
	4.6.2. <i>Parking Grove</i>	4-9
	4.6.3. <i>Overflow Parking</i>	4-9
	4.6.4. <i>Porous Pavement with Subsurface Infiltration</i>	4-10
4.7.	Driveways	4-10
4.8.	Landscape and Open Space	4-12
4.9.	Multiple Small Basins.....	4-12
4.10.	Planning Development Strategies in Practice.....	4-13
5.	TREATMENT CONTROL BMP DESIGN	5-1
5.1.	Best Management Practices Selection	5-1
	5.1.1. <i>Determine Drainage Management Areas</i>	5-1
	5.1.2. <i>Evaluate Pollutants of Concern</i>	5-2
	5.1.3. <i>Identify Candidate BMPs</i>	5-2
	5.1.4. <i>Consider Operation and Maintenance Requirements</i>	5-5
	5.1.5. <i>Other Considerations</i>	5-7
5.2.	Numeric Sizing Criteria	5-7
	5.2.1. <i>Volume-Based Best Management Practice Design</i>	5-7
	5.2.2. <i>Flow-Based BMP Design</i>	5-8
	5.2.3. <i>Combined Volume-Based and Flow-Based BMP Design</i>	5-10

5.3.	Infiltration Requirements.....	5-10
5.3.1.	<i>Soil Types and Textures</i>	5-10
5.3.2.	<i>Field Investigations</i>	5-12
5.3.3.	<i>Design Infiltration Rates</i>	5-13
5.4.	Technology Certification.....	5-13
5.5.	Feasibility Criteria.....	5-14
5.5.1.	<i>Infiltration Feasibility</i>	5-14
5.5.2.	<i>Harvest/Reuse Feasibility</i>	5-14
5.5.3.	<i>Biofiltration Feasibility</i>	5-15
6.	CONSIDERATIONS FOR CONSTRUCTION TREATMENT CONTROL BMPS.....	6-1
7.	OPERATIONS AND MAINTENANCE OF BMPS.....	7-1
7.1.	Consideration when Selecting Treatment BMPs.....	7-1
7.1.1.	<i>Sediment and Oil Removal and Disposal</i>	7-1
7.1.2.	<i>Maintenance Costs</i>	7-1
7.2.	Developing the O&M Plan.....	7-2
7.3.	Maintenance Agreements, Certification, and Modifications.....	7-2
7.4.	Inspection Requirements.....	7-3
7.5.	Minimum Maintenance Requirements.....	7-3
8.	REFERENCES.....	8-1

This page is intentionally left blank.

List of Tables

Table 1.1: Pollutants and Impacts on Water Quality	1-5
Table 2.1: Summary of Post-Construction Requirements for New and Redevelopment	2-3
Table 3.1: Estimated C-Factor for Various Surfaces during Small Storms	3-8
Table 3.2: Conventional Paving Surface Small Storm C-Factor versus Alternative Paving C-Factors ..	3-10
Table 4.1: Comparison of Three Alternatives.....	4-16
Table 5.1: Typical Pollutants Associated with Priority Projects	5-3
Table 5.2: Treatment Control BMP Categories	5-3
Table 5.3: Treatment Control BMP Expected Pollutant Removals.....	5-4
Table 5.4: Recommended Selection of Permanent BMPs.....	5-5
Table 5.5: Summary of Operation and Maintenance Effort for BMPs.....	5-5
Table 5.6: Maintenance Rank Definition.....	5-6
Table 5.7: Runoff Coefficients for Water Quality Flow Calculations.....	5-9
Table 5.8: Typical Soil Infiltration Rates ^a	5-11
Table 5.9: Test Pit/Boring Requirements for Infiltration.....	5-13

This page is intentionally left blank.

List of Figures

Figure 1.1: Document Organization	1-3
Figure 1.2: Impacts of Urbanization	1-4
Figure 2.1: Implementation of the CCH Water Quality Rules	2-2
Figure 3.1: Project Life Cycle.....	3-1
Figure 3.2: Hydraulic Altercation after Certain BMPs are Implemented.....	3-3
Figure 3.3: Directly Connected Impervious Area versus Directing Runoff to Landscaped Areas.....	3-5
Figure 3.4: Parking Lot Directing Runoff to Landscape Areas	3-6
Figure 3.5: Use of Self-Mitigating Areas	3-9
Figure 3.6: Self-Mitigating Areas Treatment Volume.....	3-9
Figure 3.7: Example of Source Control Design for Outdoor Material Storage.....	3-11
Figure 4.1: Infiltration Basin.....	4-1
Figure 4.2: Typical Infiltration Facility Schematic.....	4-2
Figure 4.3: Typical Bioretention Schematic	4-2
Figure 4.4: Simple Detention System	4-3
Figure 4.5: Retention System.....	4-3
Figure 4.6: Vegetated Swale.....	4-4
Figure 4.7: Schematic of Planter Box with Down Spout Connection and Underdrain	4-5
Figure 4.8: Comparison of Street Cross-Section (Two-Way, Residential Access Streets)	4-6
Figure 4.9: Hybrid Parking Lot.....	4-8
Figure 4.10: Hybrid Parking Lot (Honolulu, HI).....	4-8
Figure 4.11: Turf Blocks.....	4-8
Figure 4.12: Permeable Joints.....	4-8
Figure 4.13: Parking Grove 1.....	4-9
Figure 4.14: Parking Grove 2.....	4-9
Figure 4.15: Overflow Parking	4-9
Figure 4.16: Subsurface Infiltration System	4-10
Figure 4.17: Unit Pavers	4-11
Figure 4.18: Crushed Aggregate.....	4-11
Figure 4.19: Paving only under Wheels.....	4-11
Figure 4.20: Alternative 1 - Conventional.....	4-14

List of Figures

Figure 4.21: Alternative 2 - Hybrid/Best Practices..... 4-15
Figure 4.22: Alternative 3 - Neo-Traditional 4-15
Figure 5.1: DMA Delineation 5-1
Figure 5.2: Unit Water Quality Volume for 1 and 1.5 inch Runoff Depth..... 5-8
Figure 5.3: Unit Water Quality Flow 5-10
Figure 5.4: USDA Soils Textural Triangle 5-11

List of Appendices

APPENDIX A: SOURCE CONTROL BMP FACT SHEETS	A-1
SC-01: Landscaped Areas.....	A-3
SC-02: Roof Runoff Controls.....	A-7
SC-03: Automatic Irrigation System	A-11
SC-04: Storm Drain Inlet.....	A-15
SC-05: Alternative Building Materials	A-19
SC-06: Vehicle/Equipment Fueling.....	A-23
SC-07: Vehicle/Equipment Repair	A-27
SC-08: Vehicle/Equipment Cleaning.....	A-29
SC-09: Loading Dock	A-33
SC-10: Outdoor Trash Storage	A-37
SC-11: Outdoor Material Storage.....	A-41
SC-12: Outdoor Work Areas	A-45
SC-13: Outdoor Process Equipment Operations	A-49
SC-14: Parking Areas	A-53
APPENDIX B: TREATMENT CONTROL BMP FACT SHEETS.....	B-1
TC-01: Infiltration Basin	B-3
TC-02: Infiltration Trench	B-9
TC-03: Subsurface Infiltration.....	B-15
TC-04: Dry Well.....	B-17
TC-05: Bioretention Basin.....	B-21
TC-06: Permeable Pavement	B-27
TC-07: Green Roof.....	B-33
TC-08: Vegetated Bio-Filter.....	B-37
TC-09: Enhanced Swale	B-43
TC-10: Vegetated Swale.....	B-49
TC-11: Vegetated Buffer Strip	B-55
TC-12: Harvest/Reuse.....	B-59
TC-13: Detention Basin.....	B-67
TC-14: Manufactured Treatment Device.....	B-73
TC-15: Sand Filter	B-75

APPENDIX C: O&M FACT SHEETS	C-1
OM-01: Bio-Retention Basin.....	C-3
OM-02: Detention Basin.....	C-5
OM-03: Green Roof.....	C-7
OM-04: Infiltration Trench/Basin.....	C-9
OM-05: Manufactured Treatment Device	C-11
OM-06: Pervious Pavement.....	C-13
OM-07: Rainwater Harvesting.....	C-15
OM-08: Sand Filter	C-17
OM-09: Vegetated Biofilter.....	C-19
OM-10: Vegetated Swale/Strip.....	C-21

List of Acronyms and Abbreviations

§	Section	DLNR	State of Hawaii, Department of Land and Natural Resources
%	Percent		
ACQ	Ammoniacal Copper Quarentary	DMA	Drainage Management Area
BMP	Best Management Practice	DOFAW	Division of Forestry and Wildlife, Department of Land and Natural Resources, State of Hawaii
CASQA	California Stormwater Quality Association		
CCA	Chromated Copper Arsenate	DOH	Department of Health, State of Hawaii
City	City and County of Honolulu (or CCH)	DPP	Department of Planning and Permitting, City and County of Honolulu
COE	See USACE		
CORP	See USACE	ft	foot (or feet)
cu-ft	Cubic Feet (or feet ³)	HAR	Hawaii Administrative Rules
CWA	Clean Water Act	HDPE	High-Density Polyethylene
CWB	Clean Water Branch, Department of Health, State of Hawaii	hr	Hour
CWPPP	Certified Water Pollution Plan Preparer	HSG	Hydrologic Soil Group
CZMA	Coastal Zone Management Act	in	Inch (or inches)
DCIA	Directly Connected Impervious Area	IPM	Integrated Pest Management
DFM	Department of Facility Maintenance, City and County of Honolulu	LID	Low Impact Development
		MEP	Maximum Extent Practicable
		min	Minute
		mph	Miles per Hour

List of Acronyms and Abbreviations

MS4	Municipal Separate Storm Sewer System	SWPCP	Storm Water Pollution Control Plan
NJCAT	New Jersey Department of Environmental Protection, New Jersey Corporation for Advanced Technology	SWQ	Storm Water Quality Branch, Department of Facility Maintenance, City and County of Honolulu
NJDEP	New Jersey Department of Environmental Protection Protocols	SWQR	Storm Water Quality Report
NOC	Notice of Cessation	TAPE	Washington State Department of Ecology, Technology Assessment Protocol - Ecology
NOI	Notice of Intent		
NPDES	National Pollutant Discharge Elimination System	TMDL	Total Maximum Daily Load
O&M	Operations and Maintenance	TSS	Total Suspended Solids
PCB	Polychlorinated Biophenyls	UIC	Underground Injection Control
POC	Pollutants of Concern	USACE	United States Army Corporation of Engineers (also CORP or COE)
RV	Recreational Vehicle		
SC	Source Control	USDA	United States Department of Agriculture
sec	second (or seconds)	USEPA	United States Environmental Protection Agency
SPCC	Spill Prevention Control and Countermeasure	USFWS	United States Fish & Wildlife Services
sq-ft	Square Feet (of feet ²)		
SSBMP	Site-Specific Best Management Practice Plan	Water Quality Rules	City and County of Honolulu, Rules Relating to Water Quality (or WQR)
State	State of Hawaii	WQF	Water Quality Flow
Strategic Plan	Storm Water Quality Strategic Plan	WQMP	Water Quality Management Plan
SUSMP	Standard Urban Stormwater Mitigation Plan	WQV	Water Quality Volume
SWMPP	Storm Water Management Program Plan		

Glossary

As used in this document, the following definitions shall apply unless the context indicates otherwise:

303(d) Listed: Water bodies listed as impaired as per Section 303(d) of the 1972 Clean Water Act.

Best Management Practices or BMPs: means schedules of activities, prohibitions of practices, maintenance procedures, management practices, treatments, and temporary or permanent Structures or devices that are intended and designed to eliminate and Minimize the discharge of pollutants, directly or indirectly, to receiving waters, to the maximum extent practicable.

Biofiltration: A pollution control technique that uses living material to capture, and absorb or biologically degrade pollutants.

Catch Basin (Also known as Inlet): Box-like underground concrete structure with openings in curbs and gutters designed to collect runoff from streets and pavement.

Check Dams: Small temporary dams constructed across a swale or drainage ditch. Check dams reduce the velocity of concentrated storm water flows, thereby reducing erosion of the swale or ditch. The dams also decrease water velocity to increase sediment capture.

Clean Water Act (CWA): (33 U.S.C. 1251 et seq.) Requirements of the NPDES program are defined under Sections 307, 402, 318 and 405 of the CWA.

Construction Activity: Includes clearing, grading, excavation, and contractor activities that result in soil disturbance. Construction activities are regulated by the NPDES General Permit Coverage Hawaii Administrative Rules (HAR) Chapter 11-55 Water Pollution Control, Appendix C-Storm Water Associated with Construction Activities, effective October 22, 2007.

Denuded: Land stripped of vegetation or land that has had its vegetation worn down due to the impacts from the elements or humans.

Detention: The capture and subsequent release of storm water runoff from the site at a slower rate than it is collected, the difference being held in temporary storage.

Development: The sum of any and all actions that are undertaken to alter the natural or existing condition of real property or improvements on real property if a building, electric, grading, grubbing, plumbing, stockpiling or trenching permit is required for the Project. Development also includes Redevelopment and changes in land use that may result in different or increased Pollutant discharges to the MS4 or Receiving Waters. Development does not include work that does not involve any Land Disturbing Activity, the installation of signs and traffic control devices, the construction of individual bus shelters, the installation of temporary BMPs, emergency work necessary to repair surfaces that are in immediate need of stabilization, the marking of improved surfaces with striping or signage, and minor and ordinary repairs to

existing improvements in the City's right of way, provided that the work will not increase the impervious surface area of the Project Site or involve replacing 50 percent or more of the on-Site impervious surfaces area.

Discharge: A release or flow of storm water or other substance from a conveyance system or storage container. Broader discharges includes release to storm drains, etc.

Disturbed Area: Any and all portions of Project Site affected by Land Disturbing Activities. Disturbed Areas include, but are not limited to, soils and surface areas affected by excavation, areas that are graded, grubbed, or clearing by uprooting vegetation, areas affected by the demolition of foundations, areas used for equipment staging, materials, or staging, and areas affected by heavy pedestrian or vehicular traffic that disrupts ground covers or surface soil conditions.

Effluent Limits: Limitations on amounts of pollutants that may be contained in a discharge. Can be expressed in a number of ways including as a concentration, as a concentration over a time period (i.e., 30-day average must be less than 20 milligram/liter), or as a total mass per time unit, or as a narrative limit.

Erosion: The wearing-away of land surface by wind or water. Erosion occurs naturally from weather or runoff but can be intensified by land-clearing practices related to farming, new development, redevelopment, road building, or timber cutting.

Evapotranspiration: The combined loss of water into the atmosphere by evaporation (water changing from a liquid to a vapor from soil, water, or plant surfaces) and transpiration (water that is taken up by plant roots and transpired through plant tissue and leaves).

Facility: Is a collection of industrial processes discharging storm water associated with industrial activity within the property boundary or operational unit.

Flood or Flooding: The inundation to a depth of three inches or more of any property not ordinarily covered by water. The terms do not apply to inundation caused by tsunami wave action.

Grading: Any excavation or fill, or combination thereof.

Hazardous Waste: A waste or combination of wastes that, because of its quantity, concentration, or physical, chemical or infectious characteristics, may either cause or significantly contribute to an increase in mortality or an increase in serious irreversible illness; or pose a substantial present or potential hazard to human health or the environment when improperly treated, stored, transported, disposed of or otherwise managed. Possesses at least one of four characteristics (ignitability, corrosivity, reactivity, or toxicity) or appears on special USEPA or state lists. Regulated under the federal Resource Conservation and Recovery Act and the California Health and Safety Code.

Illicit Discharges: Any discharge to a municipal separate storm sewer that is not in compliance with applicable laws and regulations as discussed in this document.

Impervious Surface: A surface covering or pavement of a developed parcel of land that prevents the land's natural ability to absorb and infiltrate rainfall/storm water. Impervious surfaces include, but are not limited to, rooftops; walkways; patios; driveways; parking lots; storage areas; impervious concrete and asphalt; and any other continuous watertight pavement or covering. Landscaped soil and pervious pavement, underlain with pervious soil or pervious storage material, are not impervious surfaces.

Industrial General Permit: A National Pollutant Discharge Elimination System (NPDES) Permit issued by the State of Hawaii Department of Health Clean Water Branch for discharge of storm water associated with industrial activity.

Industrial Park: A land development that is set aside for industrial development. Industrial parks are usually located close to transport facilities, especially where more than one transport modalities coincide: highways, railroads, airports, and navigable rivers. It includes office parks, which have offices and light industry.

Infiltration: Practices which capture and temporarily store a design storm volume of water before allowing it to infiltrate into the soil.

Inlet: An entrance into a ditch, storm drain, or other waterway.

Integrated Pest Management (IPM): An ecosystem-based strategy that focuses on long-term prevention of pests or its damage through a combination of techniques such as: biological control, habitat manipulation, modification of cultural practices, and use of resistant varieties. Pesticides are used only after monitoring indicates they are needed according to established guidelines, and treatments are made with the goal of removing only the target organism.

Land Disturbing Activity or Land Disturbance: Any action, activity, or land use that alters the integrity, structure, texture, density, permeability, contents, or stress conditions of soil or ground surfaces if a building, electric, grading, grubbing, plumbing, stockpiling or trenching permit is required for the Project. Land disturbing activities include, but are not limited to actions that result in the turning, penetration, or moving of soil, the resurfacing of pavement that involves the exposure of the base course or subsurface soils, and the use of portions of a Project Site as staging areas or base yards.

Low Impact Development or “LID”: Systems and practices that use or mimic natural processes that result in the infiltration, evapotranspiration or use storm water in order to protect water quality and the aquatic habitat. At both site and regional scales, LID aims to preserve, restore, and create green space using soils, vegetation, and rain harvest techniques.

Maximum Extent Practicable or MEP: Economically achievable measures for the control of the addition of pollutants from existing and new categories of nonpoint sources of pollution, which reflect the greatest degree of pollutant reduction achievable through the application of the best available nonpoint source pollution control practices, technologies, processes, siting criteria, operating methods or other alternatives.

Municipal Separate Storm Sewer System (MS4): The City’s drainage infrastructure that is designed or intended to collect and convey storm water and includes, but is not limited to, City roads with drainage improvements, City streets, catch basins, curbs, gutters, ditches, man-made channels, and storm drains.

National Pollutant Discharge Elimination System Permit or “NPDES Permit”: The permit issued to the City pursuant to *Title 40, Code of Federal Regulations, Part 122, Subpart B, Section 122.26(a) (1) (iii)*, for storm water discharge from the City’s separate storm sewer systems; or the permit issued to a person or property owner for a storm water discharge associated with industrial activity pursuant to *Title 40, Code of Federal Regulations, Part 122, Subpart B, Section 122.26(a) (1) (ii)*, or other applicable section of Part 122; or the permit issued to a person or property owner for the discharge of any pollutant from a point source into the state waters through the City’s separate storm sewer system pursuant to Hawaii Administrative Rules, Chapter 11-55, “Water Pollution Control.”

New Development: Land disturbing activities; structural development, including construction or installation of a building or structure, the creation of impervious surfaces; and land subdivision.

Non-Storm Water Discharge: Any discharge to municipal separate storm sewer that is not composed entirely of storm water.

Nonpoint Source Pollution: Pollution that does not come from a point source. Nonpoint source pollution originates from aerial diffuse sources that are mostly related to land use.

Notice of Intent (NOI): A formal notice to the State of Hawaii Clean Water Branch submitted by the owner of an industrial site or construction site that said owner seeks coverage under a General Permit for discharges associated with industrial and construction activities. The NOI provides information on the owner, location, type of project, and certifies that the owner will comply with the conditions of the construction General Permit.

Notice of Cessation (NOC): Formal notice to the State of Hawaii Clean Water Branch submitted by owner/developer that a construction project is complete.

Outfall: The end point where storm drains discharge water into a waterway.

Point Source: Any discernible, confined, and discrete conveyance from which pollutants are or may be discharged. This term does not include return flows from irrigated agriculture or agricultural storm water runoff.

Pollutant: Any dredge, spoil, solid refuse, incinerator residue, sewage, garbage, sewage sludge, munitions, chemical waste, biological materials, radioactive materials, heat, wrecked or dismantled equipment, rock, sand, soil, sediment, dirt, industrial, municipal, or agricultural waste and substances of similar nature.

Pollution Prevention: Practices and actions that reduce or eliminate the generation of pollutants.

Precipitation: Any form of rain.

Pretreatment: Treatment of waste stream before it is discharged to a collection system.

Reclaim (Water Reclamation): Planned use of treated effluent that would otherwise be discharged without being put to direct use.

Redevelopment: The creation, addition, and/or replacement of impervious surface on improved real property. Redevelopment does not include trenching and resurfacing associated with utility work, resurfacing and reconfiguring existing impervious surfaces, the repair of sidewalks or pedestrian ramps, pothole repair, ordinary road maintenance, or the marking of vehicular or pedestrian lanes on existing roads.

Retail Mall: One or more buildings that house or form a complex of retail stores with interconnecting walkways. Retail and Commercial malls include, but are not limited to, mini-malls, strip malls, retail complexes, and enclosed shopping malls or shopping centers.

Retention: The storage of storm water to prevent it from leaving the development site.

Reuse (Water Reuse): (see Reclaim)

Runoff: Water originating from rainfall and other sources (i.e., sprinkler irrigation) that flows over the land surface to drainage facilities, rivers, streams, springs, seeps, ponds, lakes, and wetlands.

Run-on: Offsite storm water surface flow or other surface flow which enters your site.

Scour: The erosive and digging action in a watercourse caused by flowing water.

Secondary Containment: Structures, usually dikes or berms, surrounding tanks or other storage containers, designed to catch spilled materials from the storage containers.

Sedimentation: The process of depositing soil particles, clays, sands, or other sediments that were picked up by runoff.

Sediments: Soil, sand, and minerals washed from land into water, usually after rain, that collect in reservoirs, rivers, and harbors, destroying fish nesting areas and clouding the water, thus preventing sunlight from reaching aquatic plants. Farming, mining, and building activities without proper implementation of BMPs will expose sediment materials, allowing them to be washed off the land after rainfalls.

Self-Mitigating Area: A natural or landscaped area, including green roofs, which retains and/or treats rainfall within its perimeter without accepting runoff from other areas. Self-Mitigating Areas must retain all collected storm water or drain directly to the MS4.

Significant Materials: Includes, but not limited to, raw materials; fuels; materials such as solvents, detergents, and plastic pellets; finished materials such as metallic products; raw materials used in food processing or production; hazardous substances designed under Section 101(14) of CERCLA; any chemical the facility is required to report pursuant to Section 313 of Title III of SARA; fertilizers; pesticides; and waste products such as ashes, slag, and sludge that have the potential to be released with storm water discharges.

Significant Quantities: The volume, concentrations, or mass of a pollutant in storm water discharge that can cause or threaten to cause pollution, contamination, or nuisance that adversely impact human health or the environment and cause or contribute to a violation of any applicable water quality standards for receiving water.

Site Design Strategies: LID design techniques that are intended to maintain or restore the site's hydrologic and hydraulic functions with the intent of minimizing runoff volume and preserving existing flow paths.

Source Control BMPs: Low-technology practices designed to prevent pollutants from contacting storm water runoff or to prevent discharge of contaminated runoff to the storm drainage system.

Source Reduction (also Source Control): The technique of stopping and/or reducing pollutants at their point of generation so that they do not come into contact with storm water.

Storm Drains: Above- and below-ground structures for transporting storm water to streams or outfalls for flood control purposes.

Storm Water: Storm water runoff, surface runoff, street wash, or drainage and may include discharges from fire fighting activities.

Storm Water Discharge Associated with Industrial Activity: Discharge from any conveyance which is used for collecting and conveying storm water from an area that is directly related to manufacturing, processing, or raw materials storage activities at an industrial plant.

Storm Water Hotspots: Storm water hotspots are areas where land use or activities generate highly contaminated runoff, with concentrations of pollutants exceeding those typically found in storm water.

Storm Water Pollution Control Plan (SWPCP): A written plan that documents the series of phases and activities that, first, characterizes your site, and then prompts you to select and carry out actions which prevent the pollution of storm water discharges. For construction activities NOI, the Department of Health Clean Water Branch has renamed SWPCP to site-specific BMPs plan.

Storm Water Retrofit: A storm water retrofit is a storm water management practice (usually structural) put into place after development has occurred, to improve water quality, protect downstream channels, reduce flooding, or meet other specific objectives.

Treatment Control BMPs: Engineered technologies designed to remove pollutants from storm water runoff prior to discharge to the storm drain system or receiving waters.

Toxicity: Adverse responses of organisms to chemicals or physical agents ranging from mortality to physiological responses such as impaired reproduction or growth anomalies.

Acknowledgements

The Storm Water Best Management Practice (BMP) Manuals are adaptations of products of the California Stormwater Quality Association (CASQA) and other municipalities and guidance documents.

The development of the City Storm Water BMP Guide was guided by Technical Contributions from representatives of regulatory agencies (water quality and health), industry, transportation, and consulting. The quality of this manual is a result of the diverse expertise and experience of the committee and the workgroup.

This page is intentionally left blank.

1. Introduction

Storm water runoff is part of a natural hydrologic process. However, human activities particularly urbanization and agriculture, can alter natural drainage patterns and add pollutants to lakes, and streams as well as coastal bays and estuaries, and ultimately, the ocean. Numerous studies have shown urban runoff to be a significant source of water pollution, causing declines in fisheries, restrictions on swimming, and limiting our ability to enjoy many of the other benefits that water resources provide. Urban runoff in this context includes all flows discharged from urban land uses into storm water conveyance systems and receiving waters and includes both dry weather non-storm water sources (i.e., runoff from landscape irrigation, etc.) and wet weather storm water runoff. In this manual, urban runoff and storm water runoff are used interchangeably.

For many years the effort to control the discharge of storm water focused on quantity (i.e., drainage and flood control) and only to a limited extent on quality of the storm water (i.e., sediment and erosion control). However, in recent years awareness of the need to improve water quality has increased. With this awareness, Federal, State, and City programs have been established to pursue the ultimate goal of reducing pollutants contained in storm water discharges to our waterways. The emphasis of these programs is to promote the concept and the practice of preventing pollution at the source, before it can cause environmental problems (United States Environmental Protection Agency [USEPA], 1992). Other BMPs to reduce or eliminate post-project runoff should also be implemented. However, where further controls are needed, treatment of polluted runoff may be required.

1.1. Purpose and Scope

The City and County Rules Relating to Water Quality (*Water Quality Rules* or WQR) specifies that regulated new development and redevelopment projects include Low Impact Development (LID) Site Design Strategies, Source Control BMPs (best management practices), and Post-Construction Treatment Control BMPs to reduce the pollution associated with storm water runoff. This document provides planning and design guidelines to support implementation of the *Water Quality Rules*. Presented in this manual are the minimum design and technical criteria for the analysis and design of storm drainage facilities and water quality. This document also provides guidance for storm water quality during the planning phase and Operations and Maintenance (O&M) guidance. Implementing structural and operational controls that go beyond the minimum is encouraged.

1.2. Users of the Manual

This manual provides guidance suitable for use by individuals involved in development or redevelopment site water pollution control and planning. Each user of the manual is responsible for working within their capabilities obtained through training and experience, and for seeking the advice and consultation of appropriate experts at all times.

The target audience for this manual includes:

- Developers (including their planners and engineers);
- Contractors and subcontractors (including their engineers, superintendents, foremen, and construction staff);
- City agencies involved in site development and redevelopment (including their engineers, planners, and construction staff);
- Regulatory agencies (including permit and planning staff); and
- General public with an interest in storm water pollution control.

This manual also references the necessary forms and worksheets that developers, designers, consultants, contractors, and other applicants need to complete and have approved by the City and County of Honolulu (City or CCH).

1.3. Organization of the Manual

The manual is organized to assist the user in selecting and implementing BMPs to reduce impacts of storm water and non-storm water discharges on receiving waters. Sections of this manual are displayed in **Figure 1.1**.

1.4. Low Impact Development and Storm Water Quality

When rain falls in natural, undeveloped areas, the water is absorbed and filtered by soil and plants. However, for the past decades, typical urban development and storm drain systems have been designed using impermeable materials to convey storm water away from developed areas as quickly and efficiently as possible. Excess rainfall, or the portion of rainfall that is not abstracted by interception, infiltration, or depression storage, becomes surface runoff. Large areas of connected impervious cover and changes in land use often found in urban environments dramatically increase the volume and rate of storm water discharges.

Under natural and undeveloped conditions, surface runoff can range from 10 to 30 percent (%) of the total annual precipitation (**Figure 1.2**). Depending on the level of development and the site planning methods used, the alteration of physical conditions can result in a significant increase of surface runoff to over 50% of the overall precipitation. Alteration in site runoff characteristics can cause an increase in the volume and frequency of runoff flows (discharge) and velocities that cause flooding, accelerated erosion, and reduced groundwater recharge and contribute to degradation of water quality and the ecological integrity of streams.

Additionally, storm water runoff naturally contains numerous constituents, however, urbanization and urban activities including development and redevelopment typically increase constituent concentrations to levels that impact water quality. Urban activities can also result in the generation of new dry-weather runoff that may contain many of the pollutants listed in **Table 1.1**.

Pollutants associated with storm water include sediment, nutrients, bacteria and viruses, oil and grease, metals, organics, pesticides, and trash (floatables). In addition, nutrient-rich storm water runoff is an attractive medium for vector production when it accumulates and stands for more than 72 hours (hrs).

Section 1: Introduction

- *This section provides a general review of the Regulatory Background and an overview of LID.*

Section 2: Application of Permanent BMP Requirements in the City and County of Honolulu

- *This section provides an overview of the requirements for New and Redevelopment projects to comply with the City and County of Honolulu, Department of Planning and Permitting's, "Rules Relating to Water Quality."*

Section 3: Storm Water Quality Planning for New Development and Redevelopment

- *This section describes planning principles for New and Redevelopment projects including site assessment, site design strategies, and source control design.*

Section 4: Site and Facility Design for Water Quality Protection

- *This section describes how infiltration BMPs, retention/detention basins, biofilters, and structural controls can be incorporated into common site features.*

Section 5: Treatment Control BMP Design

- *This section describes BMP selection, feasibility criteria, numerical sizing criteria, and infiltration testing for the design of Treatment Control BMPs.*

Section 6: Considerations for Construction Treatment Control BMPs

- *This section outlines construction sequencing and considerations to protect permanent BMPs during construction.*

Section 7: Operations and Maintenance of BMPs

- *This section provides guidance for the operation and maintenance of BMPs to ensure BMP effectiveness.*

Section 8: References

- *This section provides a list of reference documents.*

Figure 1.1: Document Organization

LID reduces peak runoff and improves water quality by allowing rainwater to infiltrate into the ground, allowing rainwater to evaporate and transpire, or collecting rainwater as a resource for irrigation and other methods of reuse. Rather than moving storm water off-site through a conveyance system, the goal of LID is to restore the natural ability of a developed site to absorb storm water, resulting in an area more closely resembling pre-development hydrology. Importantly, the LID strategy seeks to control storm water quality at its source, using a range of small-scale, economical devices such as native landscaping and constructed green spaces, bioretention facilities, vegetated swales, infiltration through permeable pavement, and green roofs.

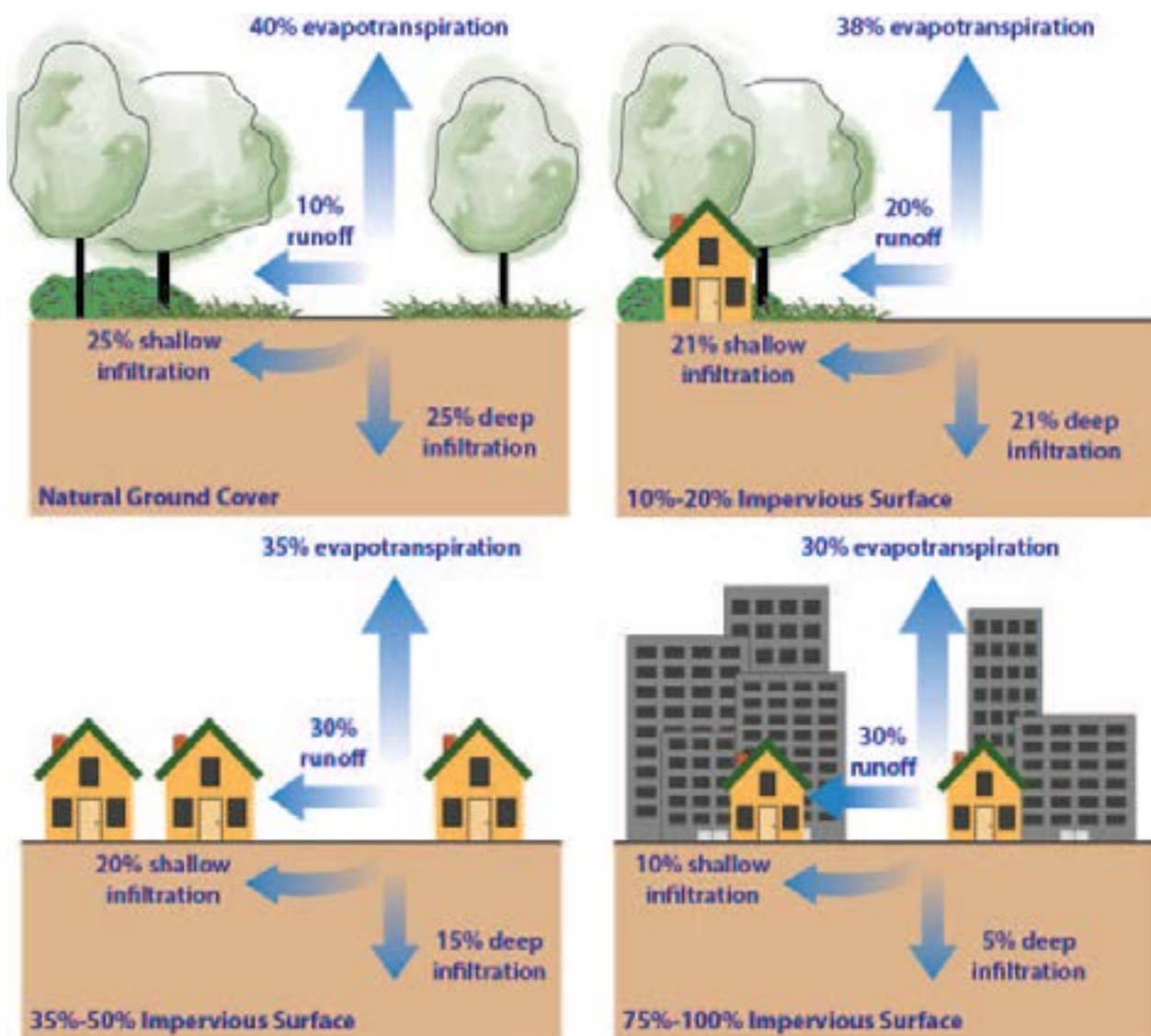

Figure 1.2: Impacts of Urbanization

Table 1.1: Pollutants and Impacts on Water Quality

Pollutant	Impact
Sediment	Sediment is a common component of storm water, and can be a pollutant. Sediment can be detrimental to aquatic life (primary producers, benthic invertebrates, coral reefs and fish) by interfering with photosynthesis, respiration, growth, reproduction, and oxygen exchange in water bodies. Sediment can transport other pollutants that are attached to it including nutrients, trace metals, and hydrocarbons. Sediment is the primary component of total suspended solids (TSS), a common water quality analytical parameter.
Nutrients	Nutrients including nitrogen and phosphorous are the major plant nutrients used for fertilizing landscapes, and are often found in storm water. These nutrients can result in excessive or accelerated growth of vegetation, such as algae, resulting in impaired use of water in lakes and other sources of water supply.
Bacteria and Viruses	Bacteria and viruses are common contaminants of storm water. For separate storm drain systems, sources of these contaminants include animal excrement and sanitary sewer overflow. High levels of indicator bacteria in storm water have led to the closure of beaches, lakes, and streams to contact recreation such as swimming.
Oil and Grease	Oil and grease includes a wide array of hydrocarbon compounds, some of which are toxic to aquatic organisms at low concentrations. Sources of oil and grease include leakage, spills, cleaning and sloughing associated with vehicle and equipment engines and suspensions, leaking and breaks in hydraulic systems, restaurants, and waste oil disposal.
Metals	Metals including lead, zinc, cadmium, copper, chromium, and nickel are commonly found in storm water. Many of the artificial surfaces of the urban environment (i.e., galvanized metal, paint, automobiles, or preserved wood) contain metals, which enter storm water as the surfaces corrode, flake, dissolve, decay, or leach. Over half the trace metal load carried in storm water is associated with sediments. Metals are of concern because they are toxic to aquatic organisms, can bioaccumulate (accumulate to toxic levels in aquatic animals such as fish), and have the potential to contaminate drinking water supplies.
Organics	Organics may be found in storm water in low concentrations. Often synthetic organic compounds (adhesives, cleaners, sealants, solvents, etc.) are widely applied and may be improperly stored and disposed. In addition, deliberate dumping of these chemicals into storm drains and inlets causes environmental harm to waterways.
Pesticides	Pesticides (including herbicides, fungicides, rodenticides, and insecticides) have been repeatedly detected in storm water at toxic levels, even when pesticides have been applied in accordance with label instructions. As pesticide use has increased, so too have concerns about adverse effects of pesticides on the environment and human health. Accumulation of these compounds in simple aquatic organisms, such as plankton, provides an avenue for biomagnification through the food web, potentially resulting in elevated levels of toxins in organisms that feed on them, such as fish and birds.
Gross Pollutants	Gross Pollutants (trash, debris, and floatables) may include heavy metals, pesticides, and bacteria in storm water. Typically resulting from an urban environment, industrial sites and construction sites, trash and floatables may create an aesthetic “eye sore” in waterways. Gross pollutants also include plant debris (such as leaves and lawn-clippings from landscape maintenance), animal excrement, street litter, and other organic matter. Such substances may harbor bacteria, viruses, vectors, and depress the dissolved oxygen levels in streams, lakes, and estuaries sometimes causing fish kills.

1.5. Regulatory Requirements

The Federal Water Pollution Control Act of 1972 also known as the Clean Water Act (CWA), as amended in 1987, is the principal legislation for establishing requirements for the control of storm water pollutants from urbanization and related activities. However, other Federal, State, and City requirements deal directly or indirectly with controlling storm water discharges. Requirements for storm water under some of these programs are evolving: Coastal Zone Management Act (CZMA), State of Hawaii Administrative Rules (HAR), City Ordinances, Total Maximum Daily Loads (TMDLs), 401 Water Quality Certifications and Endangered Species Act. The user is advised to contact local regulatory and/or City officials for further information.

1.5.1. Federal Programs

In 1972, provisions of the CWA were amended so that discharge of pollutants to waters of the United States from any point source is effectively prohibited, unless the discharge is in compliance with a National Pollutant Discharge Elimination System (NPDES) permit. The 1987 amendments to the CWA added Section 402(p), which established a framework for regulating municipal, industrial, and construction storm water discharges under the NPDES program. On November 16, 1990, USEPA published final regulations that established application requirements for storm water permits for municipal separate storm sewer systems (MS4s) serving a population of over 100,000 (Phase I communities) and certain industrial facilities, including construction sites greater than five (5) acres.

On December 8, 1999, USEPA published the final regulations for communities under 100,000 (Phase II MS4s) and operators of construction sites between one (1) and five (5) acres.

1.5.2. State Programs

The statutory framework for the NPDES program requires that all point sources that discharge pollutants in the waters of the United States must obtain an NPDES permit from the USEPA or an authorized State (Hawaii is a delegated state). Storm water is regulated under the NPDES program. There has been a phased approach to regulation of storm water. Phase I, in 1990, regulated discharges from Medium and Large MS4s, industrial activity, and construction sites greater than or equal to five (5) acres. Phase II became effective March 10, 2003 and regulated discharges from Small MS4s and construction sites from one (1) acre to five (5) acres. Large, Medium, and Small MS4s were defined by the size of the population that the system serves. The regulations required the issuance of permits to regulated dischargers.

In Hawaii, Small MS4s, industrial facilities, and construction activities greater than or equal to one acre are normally covered by general permits. However if such facilities discharge storm water into sensitive water bodies designated as Class AA marine, or Class 1 inland State waters, or areas restricted in accordance with the State's "No Discharge" policy, then those facilities must be covered by an individual permit. Also, Small MS4s and industrial facilities could be covered under an individual permit issued to a Large MS4.

Regulatory emphasis is placed on pollution prevention by regulating "end of pipe" discharges in lieu of setting effluent limits. Prevention is accomplished through the development and implementation of plans such as the MS4 Storm Water Management Program Plan (SWMPP), Industrial Storm Water Pollution Control Plans (SWPCPs), and erosion control plans and Site-Specific BMP Plans (SSBMPs) for construction sites.

Projects designated by the City as “Priority Projects” have been identified to have a greater potential for activities which may contribute sources for pollutants. These projects, described in Section 2, have been developed to reduce the risk of pollutant sources exposure to storm water runoff.

1.5.3. Other Relevant Regulatory Programs

In addition to meeting City storm water program requirements under CWA section 402(p), municipalities are increasingly subject to other regulatory drivers that relate to the protection of surface water quality and beneficial uses of water bodies in their communities. Several other regulatory programs that can significantly affect new development and redevelopment planning and design are:

- TMDLs
- Endangered Species Act
- CWA Section 404 Dredge and Fill Permits
- Section 401 Water Quality Certification (regulated under HAR, Chapter 11-54)

In the coming years, these regulatory drivers will likely have at least as much impact on the design and implementation of municipal storm water programs and BMP selection and maintenance as current storm water regulations.

1.5.4. Total Maximum Daily Loads

TMDLs are a regulatory mechanism to identify and implement additional controls on both point and non-point source discharges in water bodies that are impaired from one or more pollutants and are not expected to be restored through normal point source controls. States identify impairments and pollutants by putting impaired water bodies on a list as required under Section 303(d) of the CWA.

Storm water or urban runoff is listed as a suspected source for many of the water body pollutant combinations in the current 303(d) list. Storm water programs must be designed not only to be in compliance with the storm water NPDES permit regulations, but they must also be designed to implement TMDLs in which storm water or urban runoff is named as a source.

1.5.5. Endangered Species Act

Like TMDLs, Endangered Species Act (Hawaii Revised Statutes Title 12) issues are becoming increasingly important to storm water program design and implementation. The presence or potential presence of an endangered species impacts storm water management programs and the selection and maintenance of BMPs. The Department of Land and Natural Resources (DLNR) Division of Forestry and Wildlife (DOFAW) and the US Fish & Wildlife Service (USFWS) provides information on the designation of critical habitat in Hawaii.

The developers or public agency intending to conduct activities in or discharge to an area that serves as a critical habitat must contact resource agencies such as DLNR, DOFAW, and the USFWS to learn about specific compliance requirements and actions.

1.5.6. Clean Water Act Section 404 Dredge and Fill Permits

In 1972, Section 404 of the CWA was passed prohibiting the discharge of dredged or filled material into U.S. waters without a permit from the Army Corps of Engineers (USACE or CORP or COE). Subsequent

court rulings and litigation further defined “Waters of the U.S.” to include virtually all surface waters, including wetlands. Activities in waters of the United States that are regulated under this Act include fills for development, water resource projects (such as dams and levees), infrastructure development (such as highways and airports), and conversion of wetlands to uplands for farming and forestry.

The basic premise of the CWA is that no discharge of dredged or fill material is permitted if a practicable alternative exists that is less damaging to the aquatic environment or if the nation’s waters would be significantly degraded. When applying for a permit, it must be shown that:

- Steps have been taken to avoid wetland impacts where practicable.
- Potential impacts to wetlands have been minimized.
- Compensation for any remaining, unavoidable impacts through activities has been provided to restore or create wetlands.

An individual permit is usually required for potentially significant impacts. However, for most discharges that will have only minimal adverse effects, the USACE often grants up-front general permits. These may be issued on a nationwide or state basis for particular categories of activities (for example, minor road crossings, utility line backfill, and bedding) as a means to expedite the permitting process.

1.5.7. Clean Water Act Section 401 Water Quality Certification

Anyone proposing to conduct a project that requires a Federal permit (404) or involves dredge or fill activities that may result in a discharge to U.S. surface waters and/or “Waters of the State” is required to obtain a CWA Section 401 Water Quality Certification and/or Waste Discharge Requirements (Dredge/Fill Projects) from the State of Hawaii (State) Department of Health (DOH) Clean Water Branch (CWB), verifying that the project activities will comply with state water quality standards (HAR Chapter 11-54). The rules and regulations apply to all “Waters of the State,” including isolated wetlands and stream channels that may be dry during much of the year, have been modified in the past, look like a depression or drainage ditch, have no riparian corridor, or are on private land.

Section 401 of the CWA grants each state the right to ensure that the state’s interests are protected on any federally permitted activity occurring in or adjacent to “Waters of the State.” In Hawaii, the CWB is the agency mandated to ensure protection of the State’s waters. If a proposed project requires a USACE, CWA Section 404 permit and has the potential to impact Waters of the State, the CWB through HAR Chapter 11-54 will regulate the project and associated activities through a Water Quality Certification determination (Section 401), as part of the 404 process.

2. Application of Permanent BMP Requirements in the City and County of Honolulu

According to the *Water Quality Rules*, the following projects are required to implement post-construction BMPs for water quality:

Priority A	Priority B
<ul style="list-style-type: none">All new development and redevelopment, including any incremental development, that proposes land disturbing activities of 1 acre or more.	<ul style="list-style-type: none">Any project that may have significant water quality impacts due to its location or associated land use activities, including but not limited to the development or redevelopment of:<ul style="list-style-type: none">Retail gas outletsAutomotive repair shopsRestaurantsParking lots with 20 stalls or moreBuildings greater than 100 feet in heightRetail mallsIndustrial park

Priority B is further divided into Priority B1 and Priority B2. Priority B1 is any Priority Project with 5,000 square feet (sq-ft) or greater of impervious area. Priority B2 is any Priority Project with less than 5,000 sq-ft of Impervious Area.

The *Water Quality Rules* criteria must be met for Priority A, B1, and B2 projects as follows:

- Incorporate appropriate LID Site Design Strategies to the maximum extent practicable (MEP).
- Incorporate appropriate Source Control BMPs to the MEP.

In addition, the following criteria must be met for Priority A and B1 projects as follows:

- Retain on-site by infiltration, evapotranspiration or harvest/reuse, as much of the Water Quality Volume (WQV) as feasible, with appropriate LID Retention Post-Construction Treatment Control BMPs.
- Biofilter the remaining portion of the WQV that is not retained on-site with appropriate LID Biofiltration Post-Construction Treatment Control BMPs as much as feasible.
- If it is demonstrated to be infeasible to retain and/or biofilter the WQV, one of the following alternative compliance measures is required:
 - Treat (by detention, filtration, settling, or vortex separation) and discharge with appropriate Alternative Compliance Post-Construction Treatment Control BMPs, any portion of the WQV that is not retained on-site or biofiltered.
 - Retain or biofilter at an offsite location, the volume of runoff equivalent to the difference between the project's WQV and the amount retained on-site or biofiltered. Offsite mitigation projects must be submitted for City approval.

A flowchart of implementation of the CCH *Water Quality Rules* is shown in **Figure 2.1**.

Site Design, Source Control, and Treatment Control BMPs are discussed throughout this document. **Table 2.1** summarizes the requirements of the *Water Quality Rules* and objectives of each requirement.

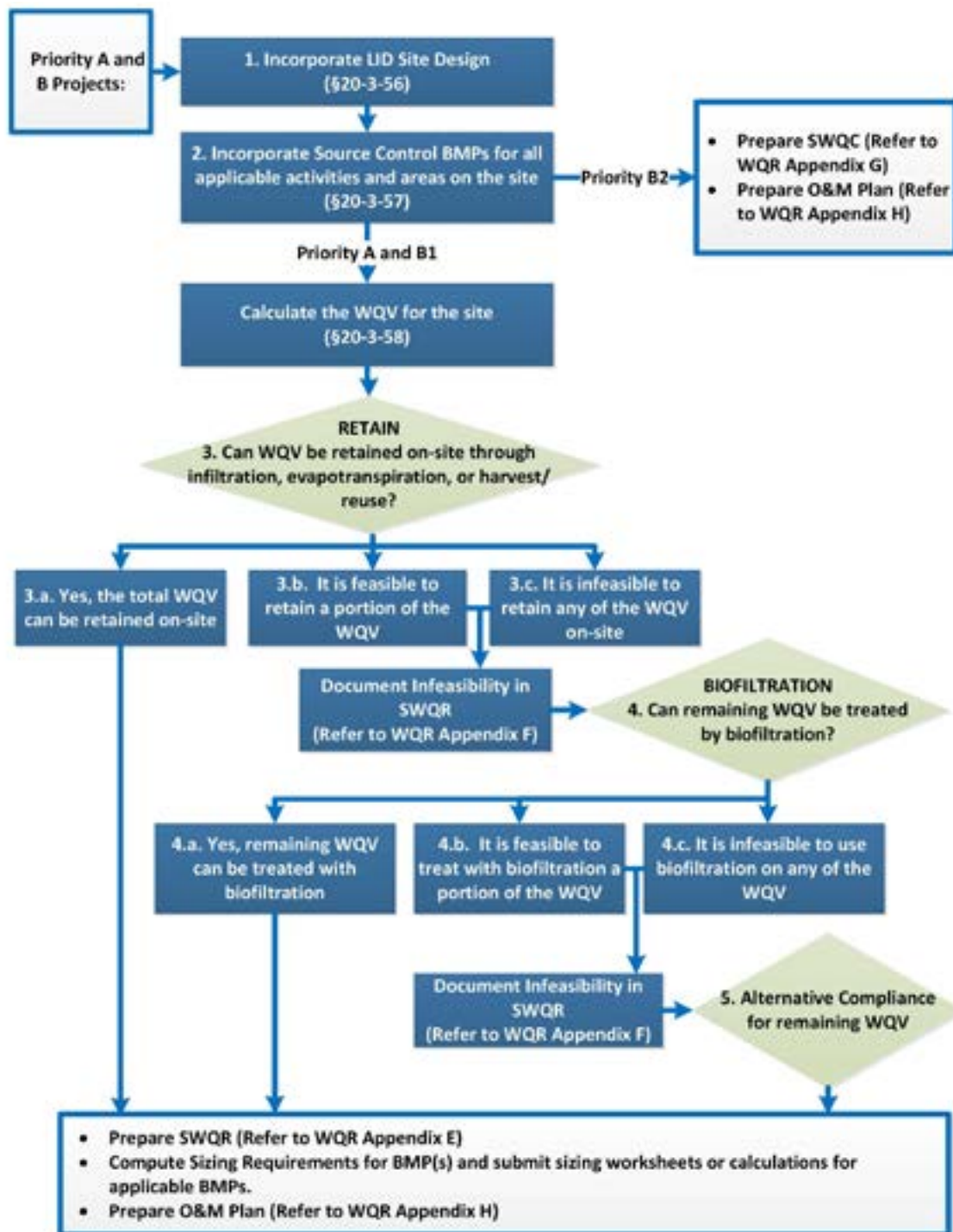

Figure 2.1: Implementation of the CCH Water Quality Rules

Table 2.1: Summary of Post-Construction Requirements for New and Redevelopment

BMP Category		Applicable Projects	Pollution Prevention Objective
LID Site Design		Required for all Priority projects; recommended for all others. See Section 3.2.	Strategies integrated into the facility design to maintain or restore the natural hydrologic functions of a site to reduce the rate of runoff, filter out its pollutants, and facilitate the infiltration of water into the ground.
Source Control		Required for all Priority projects; recommended for all others. See Source Control BMPs in Section 3.3 and Appendix A .	Low-technology practices designed to prevent pollutants from contacting storm water runoff or to prevent discharge of contaminated runoff to the storm drainage system.
Treatment Control	LID Retention	Required for Priority A and B1 projects if feasible; recommended for all others if feasible. See Treatment Control BMPs in Section 5 and Appendix B .	Engineered technologies designed to retain runoff on-site by infiltration, evapotranspiration, or reuse.
	LID Biofiltration	Required for Priority A and B1 projects if LID Retention is infeasible; recommended for all others if feasible. See Treatment Control BMPs in Section 5 and Appendix B .	Engineered technologies designed to remove pollutants from runoff by filtration, adsorption, and biological uptake.
	Alternative Compliance BMPs	Required for Priority A and B1 projects when retention and biofiltration are infeasible. See Treatment Control BMPs in Section 5 and Appendix B .	Engineered technologies designed to remove pollutants from runoff by detention, filtration, settling, or vortex separation.

2.1. City and County of Honolulu Plan Review Requirements

The City's *Water Quality Rules* requires several documents to be prepared and submitted prior to permit issuance.

2.1.1. Storm Water Quality Strategic Plans

Storm Water Quality Strategic Plans (Strategic Plans) should be submitted with or within the Master Development Plan. This requirement ensures that project developers, planners, and designers are considering storm water management early in the planning process. The Strategic Plan must include a written description of the proposed development, expected activities and pollutants that will be generated by activities at the site, and LID site design strategies that will be used to comply with the *Water Quality Rules*. The Strategic Plan must also include a development schedule.

2.1.2. Storm Water Quality Reports

An effective mechanism for documenting the incorporation of storm water quality controls into new development and redevelopment projects on a site or watershed basis is to develop a written plan known as a Storm Water Quality Report (SWQR). An effective SWQR clearly sets forth the means and methods

for long-term storm water quality protection. The SWQR will also prove to be useful during ownership transitions to convey critical storm water quality control information to subsequent owners.

SWQRs must be submitted with either a building permit application or, for projects which require a grading, grubbing, stockpiling or trenching permit, the SWQR must be submitted with construction plans for review. SWQRs must be prepared by a Certified Water Pollution Plan Preparer (CWPPP). A CWPPP must be an Architect, Engineer, Land Surveyor, or Landscape Architect licensed in the State of Hawaii. Certification can be obtained from the DPP by the successful completion of an on-line training and test.

A template is provided by the City on the Department of Planning and Permitting (DPP) website. SWQRs must contain the following information:

1. Project Name;
2. Master Plan Development Name;
3. Project Address;
4. Project Size (acres);
5. Tax Map Key;
6. The name, address, and telephone number of the owner(s)/developers of the property;
7. A description of site characteristics including drainage patterns, soils, vegetation, and steep or unstable slopes that may be of concern;
8. A description of the future activities at the site including those that would require Source Control BMPs
9. A description of the pollutants of concern (POC) expected to be generated at the site; and
10. A description of the BMPs that will be implemented including Site Design and Self-mitigating Areas, Source Control, Retention, Biofiltration, and Alternative Compliance and which POCs are addressed by those BMPs.

The following reports and plans should be included as attachments as applicable.

1. Location Map and Site Plans;
2. Existing and Proposed Drainage Plans;
3. Permanent BMP Plan including locations of all Source Control and Treatment Control BMPs and a clear and definite delineation of areas covered by vegetation or trees that will be saved;
4. Treatment Control BMP Sizing Spreadsheets;
5. Infiltration Testing Results/Geotechnical Reports;
6. Operation and Maintenance Plan;
7. Proprietary Treatment Device Information; and/or
8. Evidence or explanation for any infeasibility criteria claimed in order to comply with the requirements for infiltration, harvest/reuse, and biofiltration. Infeasibility criteria is discussed more in Section 5.5 and must be documented on the form provided by DPP which can be accessed on their website.

2.1.3. Storm Water Quality Checklists

Storm Water Quality Checklists (SWQCs) are required for Priority B2 Projects. An SWQC is similar to an SWQR but requires less information. A template is provided by on the DPP website.

SWQCs must contain the following information:

1. Project Name;
2. Master Plan Development Name;
3. Project Address;
4. Project Size (acres or square feet);
5. Impervious Area; ;
6. Tax Map Key
7. The name, address, and telephone number of the owner(s)/developers of the property;
8. BMPs that will be implemented including Site Design Strategies, Self Mitigating Areas, and Source Control BMPs.

The following reports and plans shall be included as attachments:

1. Permanent BMP Plan including locations of all Site Design Strategies, Source Control BMPs and vegetated or landscaped areas; and
2. Operations and Maintenance Plan.

2.1.4. Operations and Maintenance Plan

The *Water Quality Rules* require new development and redevelopment projects that implement Source Control and Treatment Control BMPs to regularly inspect and maintain installed BMPs to ensure they operate as designed. Permanent BMPs are also subject to annual inspections by the City's Department of Facility Maintenance (DFM). The owner/developer is required to keep records of inspection and maintenance activities for a minimum of five (5) years and be made available to the City upon request.

The owner of the property on which a permanent structural BMP is located must submit a BMP maintenance plan with the SWQR for all permanent structural BMPs. Modifications to the O&M Plan after DPP acceptance are permitted before closing applicable building and/or grading, grubbing, stockpiling, or trenching permits.

A template has been provided by the City and is available on the DPP website. O&M Plans shall include:

1. Name, phone number, and mailing address for the owner of the property.
2. Name and phone number for the individual(s), association, or management company responsible ensuring maintenance is being performed.
3. Maintenance activities for each BMP.
4. Inspection frequencies for each BMP.
5. A post-construction BMP plan showing the location of each BMP with a summary of the maintenance activities and inspection schedule for each BMP.

2.1.5. BMP Certification and Recording

Approved post-construction record drawings and the accepted O&M Plan must be recorded with the drainage connection permit in the deed for the real property on which the permanent BMP will be located. One copy of the drainage connection permit and recorded O&M Plan shall be submitted to the Director of DFM prior to closing the building and/or grading, grubbing, stockpiling, or trenching permits.

A CWPPP shall inspect to confirm that the permanent post-construction BMPs have been installed in conformance with the approved construction plans and submit the signed Certificate of Completion form prior to closing the building and/or grading permits. The certification of completion form is available on the DPP website.

2.1.6. Variances

Whenever there are practical difficulties involved in carrying out the LID Regulations, the DPP Director has the authority to grant modifications to the provisions for individual cases. These must be filed for individually and the applicant must demonstrate that the situation is unique, not caused by their own actions, and will not result in unreasonable threat of Pollutant Discharges to the MS4 or State Waters.

3. Storm Water Quality Planning for New Development and Redevelopment

The City’s program requires BMPs to be implemented by developers, property owners, and public agencies engaged in new development or redevelopment activities. Understanding new development and redevelopment in the context of the project life cycle is important for proper selection and implementation of BMPs as shown in **Figure 3.1**. The concept, planning, and design phases of a project may be spread over a period of months to many years. BMPs incorporated into the concept, planning, and design phase are much more cost-effective than the retrofit of developed projects with BMPs.

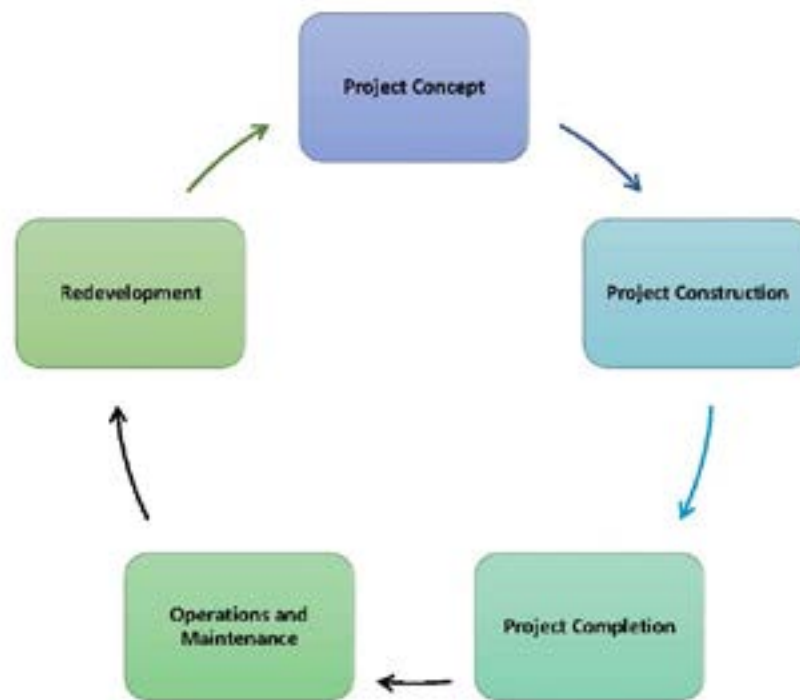

Figure 3.1: Project Life Cycle

Planning for storm water quality protection employs a multi-level strategy. To comply with the *Water Quality Rules*, the strategy consists of: 1) Site design strategies to reduce or eliminate post-project runoff; 2) Controlling sources of pollutants; and 3) Treating the remaining storm water runoff before discharging it to the storm drain system or to receiving waters.

This section describes how Elements 1 and 2 of the strategy can be incorporated into the site and facility planning and design process, and by doing so, eliminating or reducing the amount of storm water runoff that may require treatment at the point where storm water runoff ultimately leaves the site. It also describes considerations when selecting treatment to achieve Element 3.

Element 1 is referred to as a “site design strategy” because it utilizes strategies during site design to reduce or eliminate runoff.

Element 2 may be referred to as “source controls” because they emphasize reducing or eliminating pollutants in storm water runoff at their source through runoff reduction and by keeping pollutants and storm water segregated.

Element 3 of the strategy is referred to as “treatment control” because it utilizes treatment mechanisms to remove pollutants that have entered storm water runoff. Treatment controls integrated into and throughout the site usually provide enhanced benefits over the same or similar controls deployed only at the “end of the pipe” where runoff leaves the project site.

These principles are consistent with the permit and the program requirements for Priority Projects that require a combination of site design, source control BMPs (that reduce or eliminate runoff and control pollutant sources) and treatment control BMPs with specific quantitative standards. The extent to which projects can incorporate site design strategies that reduce or eliminate post project runoff will depend upon the land use and local site characteristics of each project. Reduction in post project runoff offers a direct benefit by reducing the required size of treatment controls to meet the numeric standard included in the *Water Quality Rules*. Therefore, project developers can evaluate tradeoffs between the incorporation of alternative site design and source control techniques that reduce runoff and pollutants, and the size of required treatment controls.

3.1. Assess Site Conditions

Site and watershed assessment includes assessing and describing the pre- and post-development site conditions and how the site fits into the overall watershed or drainage area. The assessment should include sufficient detail to allow for assessment of the need for and application of storm water BMPs. Information typically required is listed below and can be refined during the detailed design process.

<p><u>Site Information:</u></p> <ul style="list-style-type: none"> • Historic features • Existing features and vegetation • Planned features and activities • Topography and drainage patterns • Discharge locations • Soil types • Subsurface hydrology characterization • General climate including average precipitation and microclimates including areas of full or partial shade • Setbacks and buffer requirements 	<p><u>Vicinity Information:</u></p> <ul style="list-style-type: none"> • Major roadways • Geographic features or landmarks • Area surrounding the site • General topography • Area drainage <p><u>Watershed or Drainage Area Information:</u></p> <ul style="list-style-type: none"> • Receiving waters • Watershed drainage • Depth to groundwater
---	---

3.1.1. Understand Hydrologic Conditions of Concern

Development of impervious areas changes the landform and therefore the runoff hydrograph. Modifications to the runoff hydrograph change downstream hydrology. New development typically results in more runoff volume and higher rates of runoff. Many BMPs, such as detention basins, which

detain volume, effectively remove the top part of the hydrograph, but extend the duration of flow. See **Figure 3.2**.

Recent findings indicate that while such actions mitigate peak flows, the increased duration associated with these actions has impacts as well. Problems include washing out habitat, eroding streambed and banks, and changing downstream ecosystems. In addition to volume, rate, and duration, other factors such as the amount of energy in the water and peak flow impact downstream conditions.

A comprehensive understanding of these factors is necessary to develop meaningful storm water management plans. To be effective, these solutions must be done on an individual watershed basis.

Ideally, the runoff hydrograph that exists after construction would parallel the pre-construction hydrograph. It is difficult to ask upstream developers to be concerned about what is happening several miles below them in a watershed. On the other hand, storm water planners and policy makers must ask what can be done to make the watershed more stable, and what enhancements are needed to balance impacts to the watershed from development. Storm water quality planning for new development and redevelopment can be used to make qualitative predictions concerning channel impacts due to changes in runoff or sediment loads from the watershed.

The best way to resolve the watershed stability and balance issues is through a comprehensive drainage water master plan. A formal drainage study considers the project area's location in the larger watershed, topography, soil and vegetation conditions, percent impervious area, natural and infrastructure drainage features, and any other relevant hydrologic and environmental factors. A drainage study is typically prepared by a licensed civil engineer. As part of the study, the drainage report includes:

- Field reconnaissance to observe downstream conditions.
- Computed rainfall and runoff characteristics including a minimum of peak flow rate, flow velocity, runoff volume, time of concentration and retention volume.
- Establishment of site design, source control and treatment control measures to be incorporated and maintained to address downstream conditions of concern.

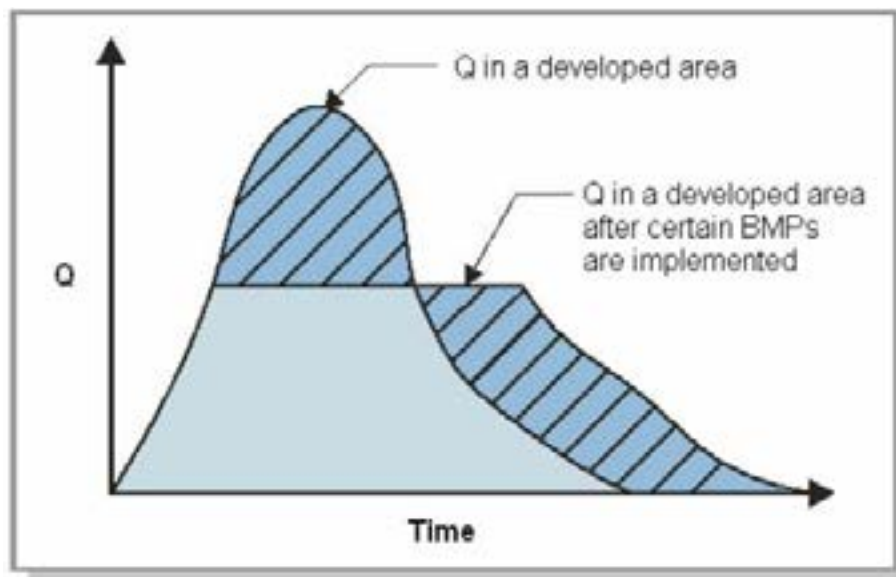

Figure 3.2: Hydraulic Altercation after Certain BMPs are Implemented

3.2. Site Design Strategies

The goal of LID Site Design is to reduce the hydrologic impact of development and to incorporate techniques that maintain or restore the site's hydrologic and hydraulic functions. The optimal LID site design minimizes runoff volume and preserves existing flow paths.

The City requires five (5) Site Design strategies:

1. Conserve natural areas, soils, and vegetation.
2. Minimize disturbances to natural drainages.
3. Minimize soil compaction.
4. Direct runoff to landscaped areas and reduce directly connected impervious areas (DCIA).
5. Minimize impervious surfaces.

3.2.1. Conserve Natural Areas, Soils, and Vegetation

The conservation of natural areas, soils, and vegetation helps to retain numerous functions of predevelopment hydrology, including rainfall interception, evapotranspiration, and infiltration. Maximizing these functions will thereby reduce the amount of runoff that must be treated. Protection of mature trees and vegetation provides habitat, prevents erosion, captures significant rainfall, provides summer shading, and reduces runoff volume and velocity which protects and enhances downstream water quality. Specific measures are:

- Preserve/protect riparian buffers.
- Preserve/protect wetlands.
- Preserve/protect natural flow pathways.
- Preserve/protect steep slopes.
- Preserve/protect sensitive environmental areas.
- Preserve/protect undisturbed vegetated areas/corridors.
- Preserve native trees and restrict disturbance of soils beneath tree canopies.
- Limit construction activities and disturbances to areas with previously disturbed soils.
- Avoid disturbing vegetation and soil on slopes and near surface waters.
- Leave an undisturbed buffer along both sides of natural streams.

Refer to Section 6 regarding considerations and sequencing practices to preserve existing vegetation during construction.

3.2.2. Minimize Disturbances to Natural Drainages

Natural drainages offer a benefit to storm water management as the soils and habitat already function as a natural filtering/infiltrating swale. Minimizing disturbances to natural drainage patterns preserves the predevelopment timing, rate, and duration of runoff as well as preserving streamside habitats. When determining the development footprint of the site, natural drainages should be avoided. By keeping the development envelope set back from natural drainages, the drainage can retain its water quality benefit to the watershed. Specific measures are:

- Limit site disturbance, clearing, and grading to the smallest areas necessary.
- Maintain surface flow patterns of undeveloped sites.

- Maintain existing water body alignments, sizes, and shapes.
- Minimize and control construction traffic areas.
- Minimize and control construction stockpiling and storage areas.
- Use construction fencing to mark where no disturbances will be allowed.

3.2.3. Minimize Soil Compaction

Clearing, grading and compaction by construction traffic reduces the natural absorption and infiltration capacities of the native soils. Soil compaction damages soil structure, reduces infiltration rates, limits root growth and plant survivability, and destroys soil organisms. Subsequent tilling and/or addition of soil amendments such as compost can help, but will not restore the original infiltration capacity of the soils. By protecting native soils and vegetation in appropriate areas during the clearing and grading phase of development the site can retain some of its existing beneficial hydrologic function. Specific measures are:

- Protect soils against compaction and rutting in areas where traffic is unavoidable.
- Minimize the size of construction easements and material storage areas.
- Limit areas of heavy equipment.
- Prohibit working on wet soils with heavy equipment.
- Restore compacted open space areas with tilling and soil amendments.
- Avoid extensive and unnecessary clearing and stockpiling of topsoil.
- Avoid/minimize soil compaction in open space, landscaped, and proposed LID BMP areas.
- Prepare soil amendments off-site.

3.2.4. Direct Runoff to Landscape Areas and Reduce Directly Connected Impervious Areas

Any impervious surface that drains into a catch basin, area drain, or other conveyance structure is a DCIA. Impervious areas directly connected to the storm drain system are the greatest contributor to non-point source pollution. The first effort in site planning and design for storm water quality protection is to minimize the DCIA as shown in **Figure 3.3**.

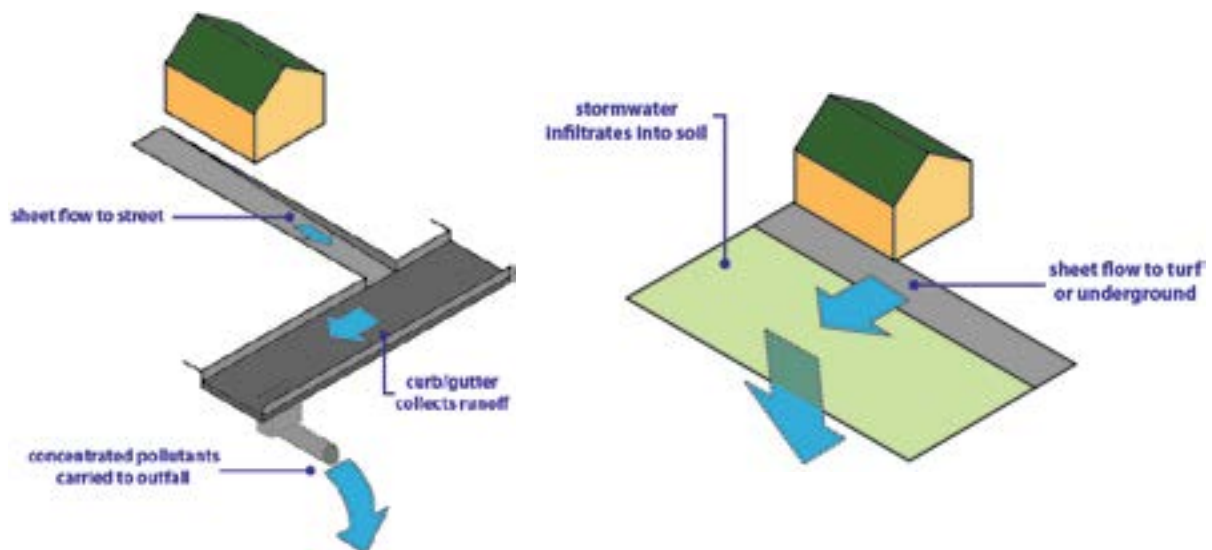

Figure 3.3: Directly Connected Impervious Area versus Directing Runoff to Landscaped Areas

As storm water runoff flows across parking lots, roadways, and paved areas, the oils, sediments, metals, and other pollutants are collected and concentrated. If this runoff is collected by a drainage system and carried directly along impervious gutters or in closed underground pipes, it has no opportunity for filtering by plant material or infiltration into the soil. It also increases in speed and volume, which may cause higher peak flows downstream, and may require larger capacity storm drain systems, increasing flood and erosion potential. Solutions that reduce DCIA prevent runoff, detain or retain surface water, attenuate peak runoff rates, benefit water quality and convey storm water. Specific measures are:

- Design roof drains to flow to vegetated areas.
- Direct flow from paved areas to stabilized landscaped/vegetated areas (See **Figure 3.4**).
- Grade paved areas to achieve sheet flow to landscaped areas.
- Break up flow directions from large paved surfaces.



Figure 3.4: Parking Lot Directing Runoff to Landscape Areas

3.2.5. *Minimize Impervious Surfaces*

The principle of runoff reduction starts by recognizing that developing or redeveloping land within a watershed inherently increases the imperviousness of the areas and therefore the volume and rate of runoff and the associated pollutant load.

The extent of impervious land covering the landscape is an important indicator of storm water quantity and quality and the health of urban watersheds. Studies have demonstrated a direct correlation between the degree of imperviousness of an area and the degradation of its receiving waters. Impervious land coverage is a fundamental characteristic of the urban and suburban environment; rooftops, roadways, parking areas, and other impenetrable surfaces cover soils that allowed rainwater to infiltrate before development.

Without these impervious coverings, inherent watershed functions would naturally filter rainwater and prevent receiving water degradation. Impervious surfaces associated with urbanization can cause adverse receiving water impacts in four (4) ways:

1. Rainwater is prevented from filtering into the soil, adversely affecting groundwater recharge and reducing base stream flows.
2. Because it cannot filter into the soil, more rainwater runs off, and runs off more quickly, causing increased flow volumes, accelerating erosion in natural channels, and reducing habitat and other stream values. Flooding and channel destabilization often require further intervention. As a result, riparian corridors are lost to channelization, further reducing habitat values.

3. Pollutants that settle on the impervious pavements and rooftops are washed untreated into storm sewers and nearby stream channels, increasing pollution in receiving water bodies.
4. Impervious surfaces retain and reflect heat, increasing ambient air and water temperatures. Increased water temperature negatively impacts aquatic life and reduces the oxygen content of nearby water bodies.

These techniques include actions to:

- Manage watershed impervious area.
- Include self-mitigating areas.
- Consider runoff reduction areas.

Manage Watershed Impervious Area

Land use planning on the watershed scale is a powerful tool to manage the extent of impervious land coverage and is especially applicable to larger scale community development and master planning. First, identify open space and sensitive resource areas and target growth to areas that are best suited to development, and second, plan development that is compact to reduce overall land conversion to impervious surfaces and reliance on land-intensive streets and parking systems.

Water resource protection is becoming more complex. A wide variety of regulatory agencies, diverse sources of non-point source pollution, and a multitude of stakeholders make it difficult to achieve a consistent, easily understandable strategy for watershed protection. Impervious land coverage is a scientifically sound, easily communicated, and practical way to measure the impacts of new development on water quality.

Impervious area reductions also provide additional benefits such as reduced urban heat island effect, resulting in less energy use to cool structures and more efficient irrigation use by plants. Reductions have also been attributed to more human-scale landscaping and higher property values.

Strategies for reducing impervious land coverage include:

- Cluster buildings so that they require less driveways and pathways.
- Taller narrower buildings rather than lower spreading ones.
- Sod or vegetative “green roofs” rather than conventional roofing materials.
- Pervious pavement for light duty roads, parking lots, and pathways.
- Use open space or hybrid street plan instead of grid and curvilinear.
- Maximize utilization of compact car spaces in parking areas.
- Reduce driveway sizes.

Many of these strategies are discussed in Section 3. Two (2) of the strategies to Minimize Impervious Surfaces result in direct benefit to treatment control requirements: Self-Mitigating Areas and Runoff Reduction Areas. These two (2) strategies result in a smaller WQV requiring treatment under the City’s *Water Quality Rules*.

Include Self-Mitigating Areas

Developed areas may provide “self-mitigation” of runoff if properly designed and drained.

A self-mitigating area is a natural or landscape area which retain and/or treat rainfall over the footprint of the self-mitigating area but do not accept runoff from other areas. Self-mitigating areas can drain directly offsite or to the public storm drain system without being treated by a structural BMP.

Self-mitigating areas might include:

- Conserved natural spaces
- Landscaped areas (including parks and lawns)
- Grass/vegetated swales
- Green roofs

The infiltration and biotreatment inherent to such areas provides the treatment control necessary. These areas therefore act as their own BMP, and no additional BMPs to treat runoff are required.

As illustrated in **Figure 3.5**, site drainage designs must direct runoff from self-treating areas away from other areas of the site that require treatment of runoff. Otherwise, the volume from the self-mitigating area will only add to the volume requiring treatment from the impervious area as demonstrated in **Figure 3.6**.

Likewise, under this philosophy, self-mitigating areas receiving runoff from treatment-required areas would no longer be considered self-mitigating, but rather would be considered as the BMPs in place to treat that runoff. These areas could remain as self-mitigating, or partially self-mitigating areas, if adequately sized to handle the excess runoff addition.

Consider Runoff Reduction Areas

Using alternative surfaces with a lower coefficient of runoff or “C-Factor” can reduce runoff from developed areas. The C-Factor is a representation of the surface’s ability to produce runoff. Surfaces that produce higher volumes of runoff are represented by higher C-Factors, such as impervious surfaces. Surfaces that produce smaller volumes of runoff are represented by lower C-Factors, such as more pervious surfaces. See **Table 3.1** for typical C-Factor values for various surfaces during small storms.

Table 3.1: Estimated C-Factor for Various Surfaces during Small Storms

Paving Surfaces	C-Factor	Paving Surfaces	C-Factor
Concrete	0.80	Permeable interlocking concrete pavement	0.10
Stone, brick, or concrete pavers with mortared joints and bedding	0.80	Grid pavements with grass or aggregate surface	0.10
Asphalt	0.70	Crushed aggregate	0.10
Stone, brick, or concrete pavers with sand joints and bedding	0.70	Grass	0.10
Pervious concrete	0.10	Grass over porous plastic	0.05
Porous asphalt	0.10	Gravel over porous plastic	0.05

Note: C-Factors for small storms are likely to differ (be lower) than C-Factors developed for large, flood control volume size storms. The above C-Factors were produced by selecting the lower end of the best available C-Factor range for each paving surface. These C-Factors are only appropriate for small storm treatment design, and should not be used for flood control sizing.

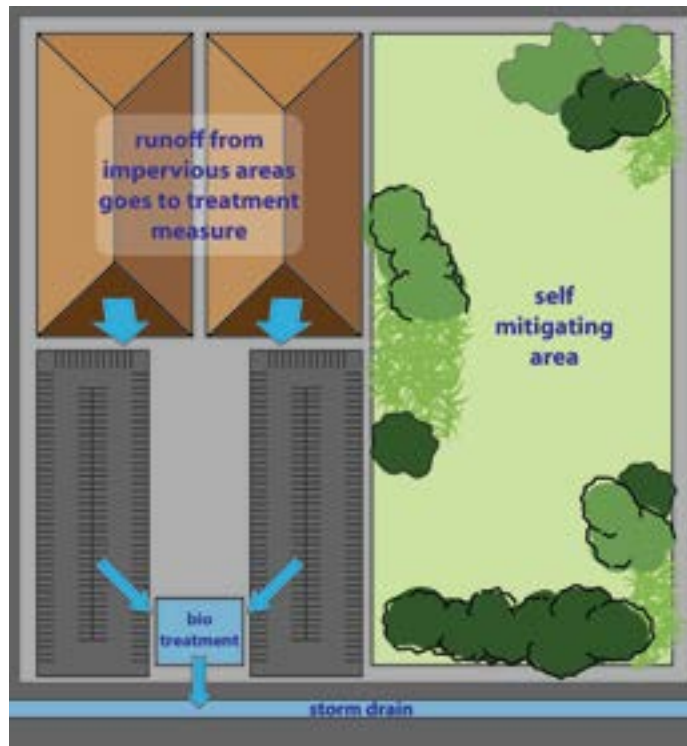

Figure 3.5: Use of Self-Mitigating Areas

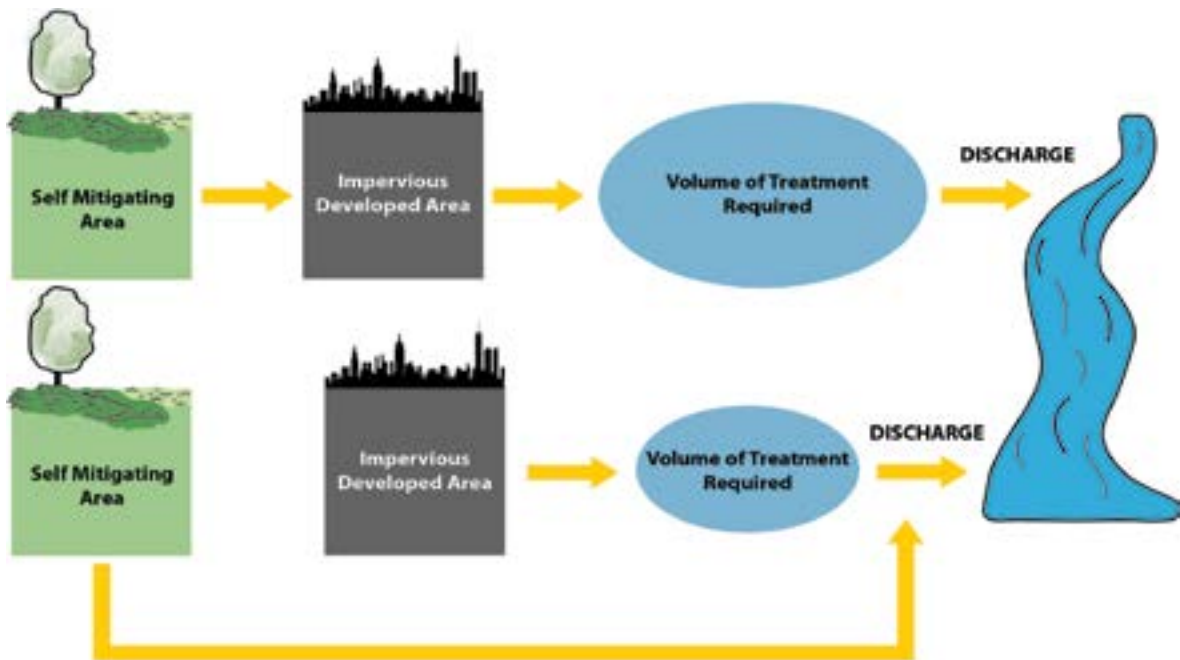

Figure 3.6: Self-Mitigating Areas Treatment Volume

Site design techniques that incorporate pervious materials may be used to reduce the C-Factor of a developed area, reducing the amount of runoff requiring treatment. These materials include:

- Pervious concrete
- Pervious asphalt
- Turf block
- Brick (un-grouted)
- Natural stone
- Concrete unit pavers
- Crushed aggregate
- Cobbles
- Wood mulch

Table 3.2 compares the C-Factors of conventional paving surfaces to alternative; lower C-Factor paving surfaces. By incorporating more pervious, lower C-Factor surfaces into a development (see **Figure 3.7**); lower volumes of runoff may be produced. Lower volumes and rates of runoff translate directly to lower treatment requirements.

Table 3.2: Conventional Paving Surface Small Storm C-Factor versus Alternative Paving C-Factors

Conventional Paving Surface C-Factors	Reduced C-Factor for Paving Alternatives
<ul style="list-style-type: none"> • Concrete Patio/Plaza (0.80) • Asphalt Parking Area (0.70) 	<ul style="list-style-type: none"> • Decorative unit Pavers on Sand (0.10) • Turf Block Overflow Parking Area (0.10) • Pervious Concrete (0.10) • Pervious Asphalt (0.10) • Crushed Aggregate (0.10)

Other site design techniques such as disconnecting impervious areas, preservation of natural areas, and designing concave medians may be used to reduce the overall C-Factor of development areas.

3.3. Control Sources of Pollutants

There are a number of items that can be routinely designed into a project that function as source controls once a project is completed. Design of BMPs to control exposure to pollutants is guided by two (2) general principles:

1. Prevent water from contacting work areas. Work and storage areas should be designed to prevent storm water runoff from passing through shipping areas, vehicle maintenance yards, and other work places before it reaches storm drains. The objective is to prevent the discharge of water laden with grease, oil, heavy metals and process fluids to surface waters or sensitive resource areas.
2. Prevent pollutants from contacting surfaces that come into contact with storm water runoff. Precautionary measures should be employed to keep pollutants from contacting surfaces that come into contact with runoff. This means controlling spills and reviewing operational practices and equipment to prevent pollutants from coming into contact with storm or wash water runoff.

Examples of structural source controls include covers, impermeable surfaces, secondary containment facilities, runoff diversion berms, and diversions to wastewater treatment plants. See **Figure 3.7**.

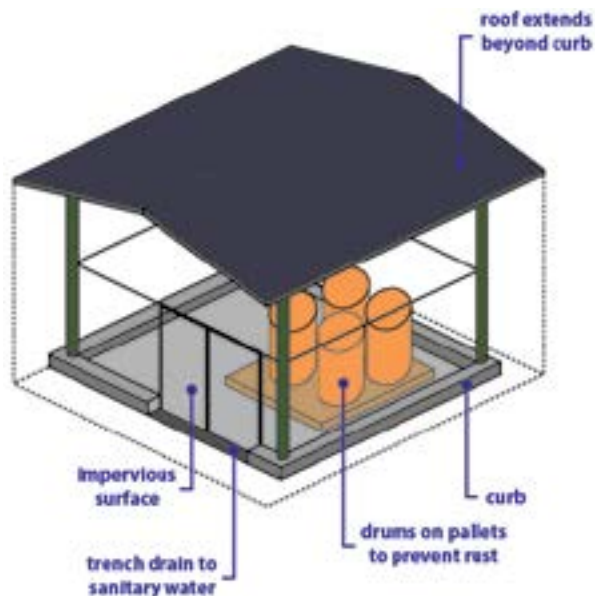

Figure 3.7: Example of Source Control Design for Outdoor Material Storage

The *Water Quality Rules* require that Source Control BMPs are required for all Priority A and B projects for the following activities and areas:

Activity or Area Required to Implement Source Control	BMP Fact Sheet (Appendix A)
Landscaped Areas	SD-01
Automatic Irrigation System	SD-03
Storm Drain Inlets	SD-04
Vehicle/Equipment Fueling	SD-06
Vehicle/Equipment Repair	SD-07
Vehicle/Equipment Cleaning	SD-08
Loading Docks	SD-09
Outdoor Trash Storage	SD-10
Outdoor Material Storage	SD-11
Outdoor Work Areas	SD-12
Outdoor Process Equipment Operations	SD-13
Parking Areas	SD-14

Source control fact sheets are provided in **Appendix A**. In addition, fact sheets are provided for Roof Runoff Controls (SD-02) and Alternative Building Materials (SD-05) which are not required by the *Water Quality Rules*.

The following information is provided for each of the above-listed BMPs:

- Brief Description/Approach
- Suitable Applications
- Design Considerations

- Design Guidelines
- Examples
- Operations & Maintenance Recommendations

3.4. Treat Runoff

Today's drainage systems must meet multiple purposes: protect property from flooding, control stream bank erosion, and protect water quality. To achieve this, designers must integrate conventional flood control strategies for large, infrequent storms with storm water quality control strategies.

There are several basic water quality strategies for treating runoff:

- Infiltrate runoff into the soil.
- Capture, store, and reuse runoff on site.
- Convey runoff slowly through vegetation.
- Treat runoff on a flow-through basis using various treatment technologies.
- Retain/detain runoff for later release with the detention providing treatment.

Solutions should be based on an understanding of the water quality and economic benefits inherent in construction of systems that utilize or mimic natural drainage patterns. Site designs should be based on site conditions and use these as the basis for selecting appropriate storm water quality controls. The drainage system design process considers variables such as local climate, the infiltration rate and erosivity of the soils, and slope.

Unlike conveyance models, which are assessed by simple quantitative measures (flood control volumes and economics), water quality designs must optimize a complex array of both quantitative and qualitative standards, including engineering worthiness, environmental benefit, horticultural sustainability, aesthetics, functionality, maintainability, economics and safety.

Treatment Control BMPs are discussed in more detail in Section 5.

4. Site and Facility Design for Water Quality Protection

Many common site features can achieve storm water management goals by incorporating one or more basic elements, either alone or in combination, depending on site and other conditions. The basic elements include infiltration, retention/detention, biofilters, and structural controls. This section first describes these basic elements, and then describes how these elements can be incorporated into common site features.

4.1. Infiltration

Infiltration is the process where water enters the ground and moves downward through the unsaturated soil zone. Infiltration is ideal for management and conservation of runoff because it filters pollutants through the soil and restores natural flows to groundwater and downstream water bodies. See **Figure 4.1**.

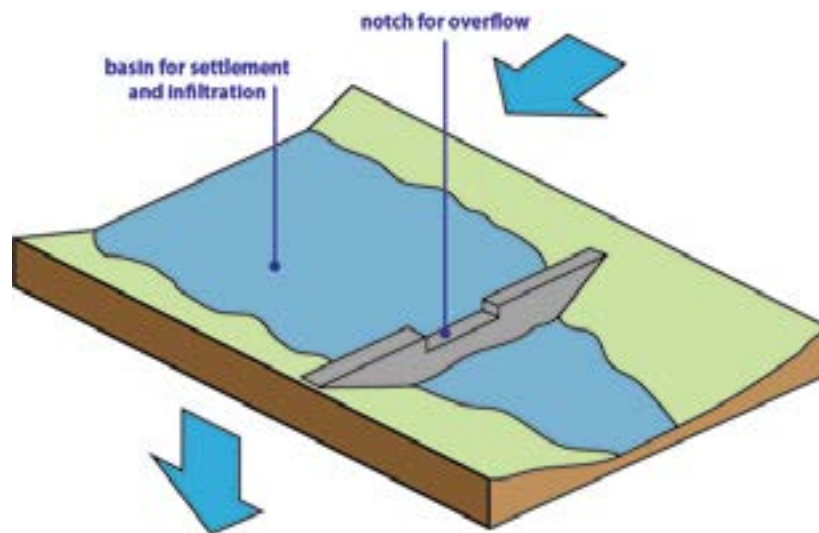

Figure 4.1: Infiltration Basin

The infiltration approach to storm water management seeks to “preserve and restore the hydrologic cycle.” An infiltration storm water system seeks to infiltrate runoff into the soil by allowing it to flow slowly over permeable surfaces (see **Figure 4.2** and **Figure 4.3**).

The slow flow of runoff allows pollutants to settle into the soil where they are naturally mitigated. The reduced volume of runoff that remains takes a long time to reach the outfall, and when it empties into a natural water body or storm sewer, its pollutant load is greatly reduced.

Infiltration basins can be either open or closed. Open infiltration basins include ponds, swales and other landscape features and are usually vegetated to maintain the porosity of the soil structure and to reduce erosion. Infiltration trenches and dry wells can also fall into this category although not typically vegetated.

Closed infiltration basins can be constructed under the land surface with open graded crushed stone, leaving the surface to be used for parking or other uses. Subsurface closed basins are generally more difficult to maintain and more expensive than open filtration systems, and are used primarily where high land costs demand that the land surface be reclaimed for economic use.

Infiltration systems are often designed to capture the “first flush” storm event and used in combination with a detention basin to control peak hydraulic flows. They effectively remove suspended solids, particulates, bacteria, organics and soluble metals and nutrients through the vehicle of filtration, absorption and microbial decomposition. Groundwater contamination should be considered as a potential adverse effect and should be considered where shallow groundwater is a source of drinking water. In cases where groundwater sources are deep, there is a very low chance of contamination from normal concentrations of typical urban runoff.

Bioretention facilities have the added benefit of aesthetic appeal and small scale applicability. These systems can be placed in parking lot islands, landscaped areas surrounding buildings, perimeter parking lots, and other open space sections. Placing bioretention facilities on land that City regulations require developers to devote to open space efficiently uses the land. An experienced landscape architect can choose plant species and planting materials that are easy to maintain, aesthetically pleasing, and capable of effectively reducing pollutants in runoff from the site.

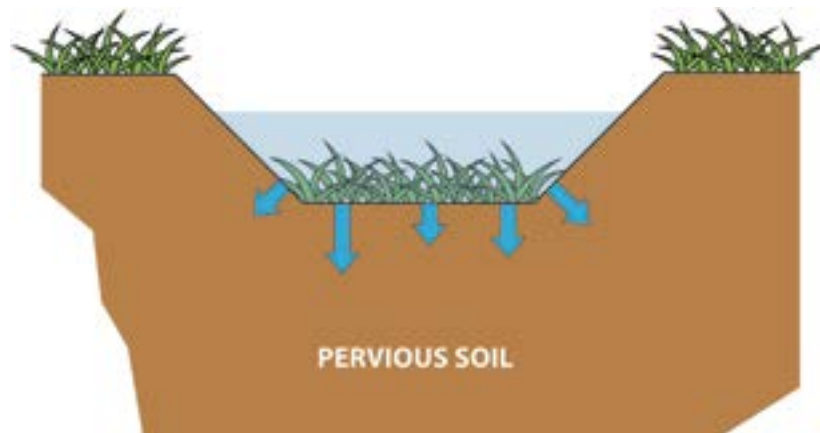

Figure 4.2: Typical Infiltration Facility Schematic

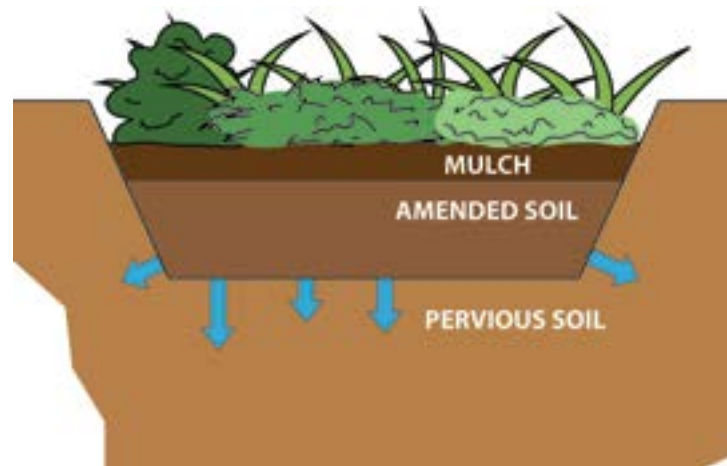

Figure 4.3: Typical Bioretention Schematic

4.2. Retention and Detention

Retention and detention systems differ from infiltration systems primarily in intent. Retention and detention systems may release runoff slowly enough to reduce downstream peak flows to their predevelopment levels, allow fine sediments to settle, and uptake dissolved nutrients in the runoff where wetland vegetation is included. Detention systems are designed to capture and retain runoff temporarily and release it to receiving waters at predevelopment flow rates (see **Figure 4.4**). Permanent pools of water are not held between storm events. Pollutants settle out and are removed from the water column through physical processes. Detention systems are allowed under the *Water Quality Rules* for the portions of the WQV that are infeasible to treat with infiltration, harvest/reuse, and Biofiltration BMPs.

Retention systems capture runoff and retain it between storms as shown in **Figure 4.5**. While infiltration does occur, water held in the system is displaced by the next significant rainfall event. Pollutants settle out and are thereby removed from the water column. Because water remains in the system for a period of time, retention systems benefit from biological and biochemical removal mechanisms provided by aquatic plants and microorganisms.

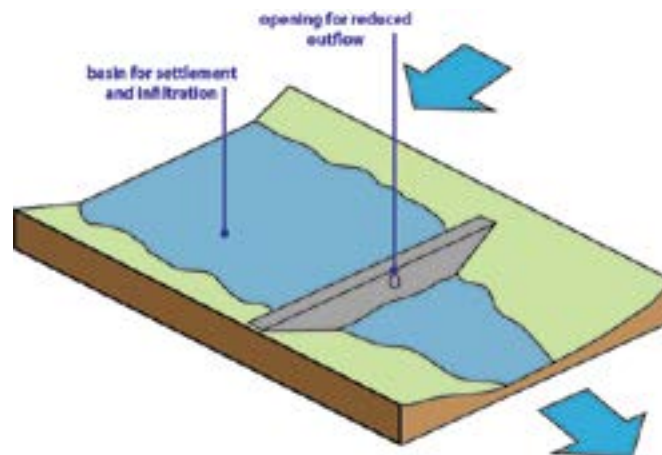

Figure 4.4: Simple Detention System

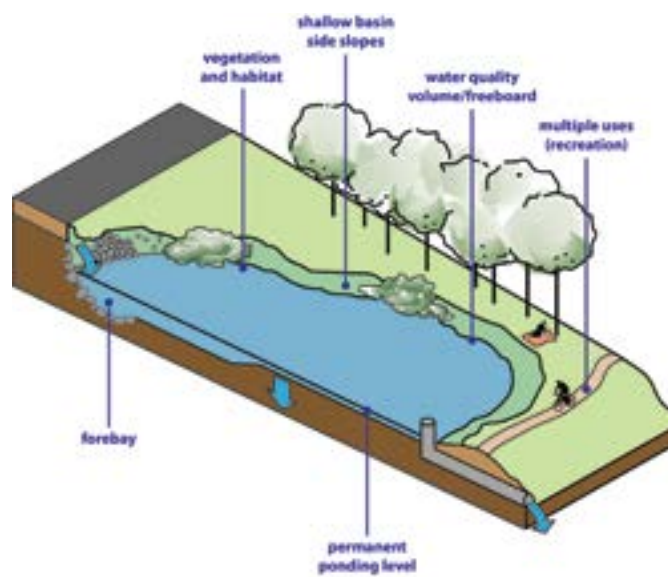

Figure 4.5: Retention System

Constructed wetland systems retain and release storm water in a manner that is similar to retention or detention basins. The design mimics natural ecological functions and uses wetland vegetation to filter pollutants. The system needs a permanent water source to function properly and must be engineered to remove coarse sediment, especially construction related sediments, from entering the pond. Storm water has the potential to negatively affect natural wetland functions and constructed wetlands can be used to buffer sensitive resources.

4.3. Biofilters

Biofilters can consist of vegetated swales and filter strips, green roofs, and engineered or proprietary biofiltration devices such as planter boxes and tree box filters.

Swales are vegetated slopes and channels designed and maintained to transport shallow depths of runoff slowly over vegetation (see **Figure 4.6**). Swales are generally effective if flows are slow [1 ft/second (sec) maximum] and depths are shallow (4 inch maximum). The slow movement of runoff through the vegetation provides an opportunity for sediments and particulates to be filtered and degraded through biological activity. In most soils, the biofilter can also provide an opportunity for storm water infiltration, which further removes pollutants and reduces runoff volumes.

Swales intercept both sheet and concentrated flows and convey these flows in a concentrated, vegetation-lined channel. Grass filter strips intercept sheet runoff from the impervious network of streets, parking lots, and rooftops and divert storm water to a uniformly graded meadow, buffer zone, or small forest. Typically, the vegetated swale and grass strip-planting palette can comprise a wide range of possibilities from dense vegetation to turf grass. Grass strips and vegetated swales can function as pretreatment systems for water entering bioretention systems or other BMPs. If biofilters are to succeed in filtering pollutants from the water column, the planting design must consider the hydrology, soils, and maintenance requirements of the site.

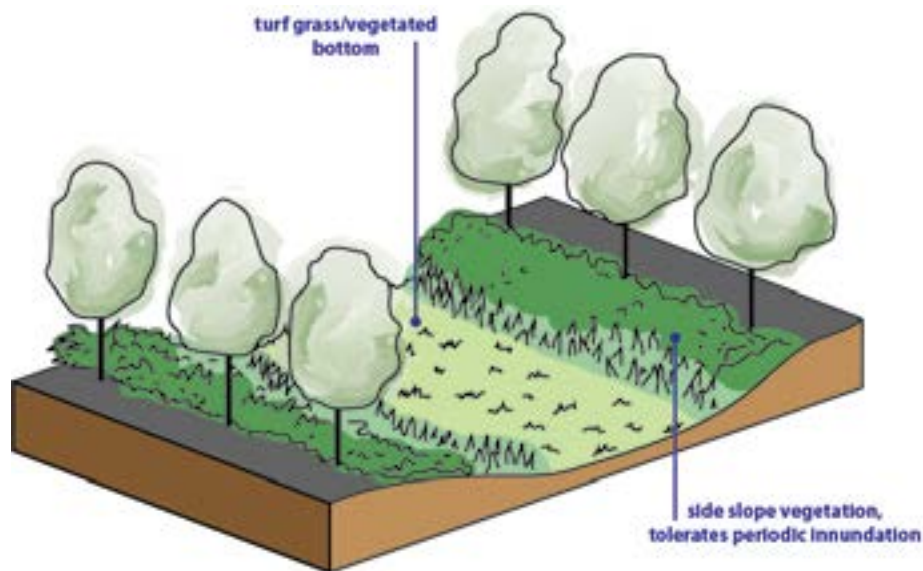

Figure 4.6: Vegetated Swale

Appropriate plants not only improve water quality, but provide habitat and aesthetic benefits. Selected plant materials must be able to adapt to variable moisture regimes. Turf grass is acceptable if it can be watered in the dry season, and if it is not inundated for long periods.

Biofilters also include engineered or proprietary systems such as planter boxes, tree box filters, or similar. They function as soil and plant-based filtration systems, similar to swales that remove pollutants through a variety of physical, biological and chemical treatment processes. The components normally consist of a ponding area, mulch layer, planting soils, plantings, and either a pervious or impervious bottom layer with underdrain (see **Figure 4.7**). These devices can work hand in hand with down spout disconnections.

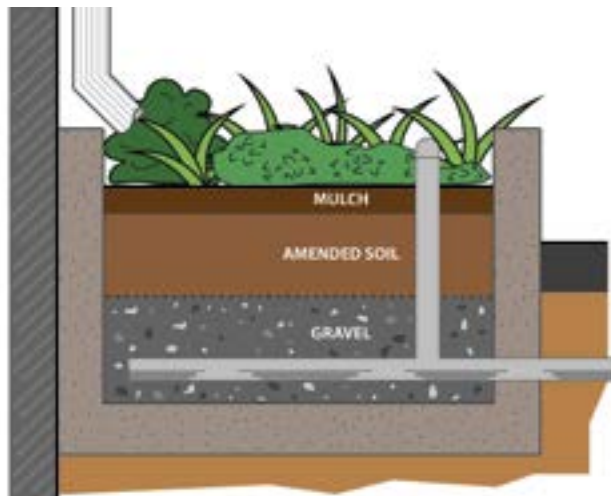

Figure 4.7: Schematic of Planter Box with Down Spout Connection and Underdrain

4.4. Street Design

Street design is mandated by City standards. More than any other single element, street design has a powerful impact on storm water quality. Street and other transportation-related structures typically can comprise between 60 to 70% of the total impervious coverage in urban areas and, unlike rooftops, streets are almost always directly connected to an underground storm water system.

Recognizing that street design can be the greatest factor in development's impact on storm water quality, it is important that designers and developers employ street standards that reduce impervious land coverage. Directing runoff to biofilters or swales rather than underground storm drains produces a street system that conveys storm water efficiently while providing both water quality and aesthetic benefits.

On streets where a more urban character is desired, or where a rigid pavement edge is required, curb and gutter systems can be designed to empty into drainage swales. These swales can run parallel to the street, in the parkway between the curb and the sidewalk, or can intersect the street at cross-angles, and run between residences, depending on topography or site planning. Runoff travels along the gutter, but instead of being emptied into a catch basin and underground pipe, multiple openings in the curb direct runoff into surface swales or infiltration/detention basins.

In recent years, new street standards have been gaining acceptance that meets the access requirements of local residential streets while reducing impervious land coverage. These standards create a new class of street that is narrower and more interconnected than the current local street standard, called an "access"

street. An access street is at the lowest end of the street hierarchy and is intended only to provide access to a limited number of residences.

A street standard that allows an interconnected system of narrow access streets for residential neighborhoods has the potential to achieve several complimentary environmental and social benefits. A hierarchy of streets sized according to average daily traffic volumes yields a wide variety of benefits: improved safety from lower speeds and volumes, improved aesthetics from street trees and green parkways, reduced impervious land coverage, less heat island effect, and lower development costs. If the reduction in street width is accompanied by a drainage system that allows for infiltration of runoff, the impact of streets on storm water quality can be greatly mitigated.

A comparison of street cross-sections is shown in **Figure 4.8**.

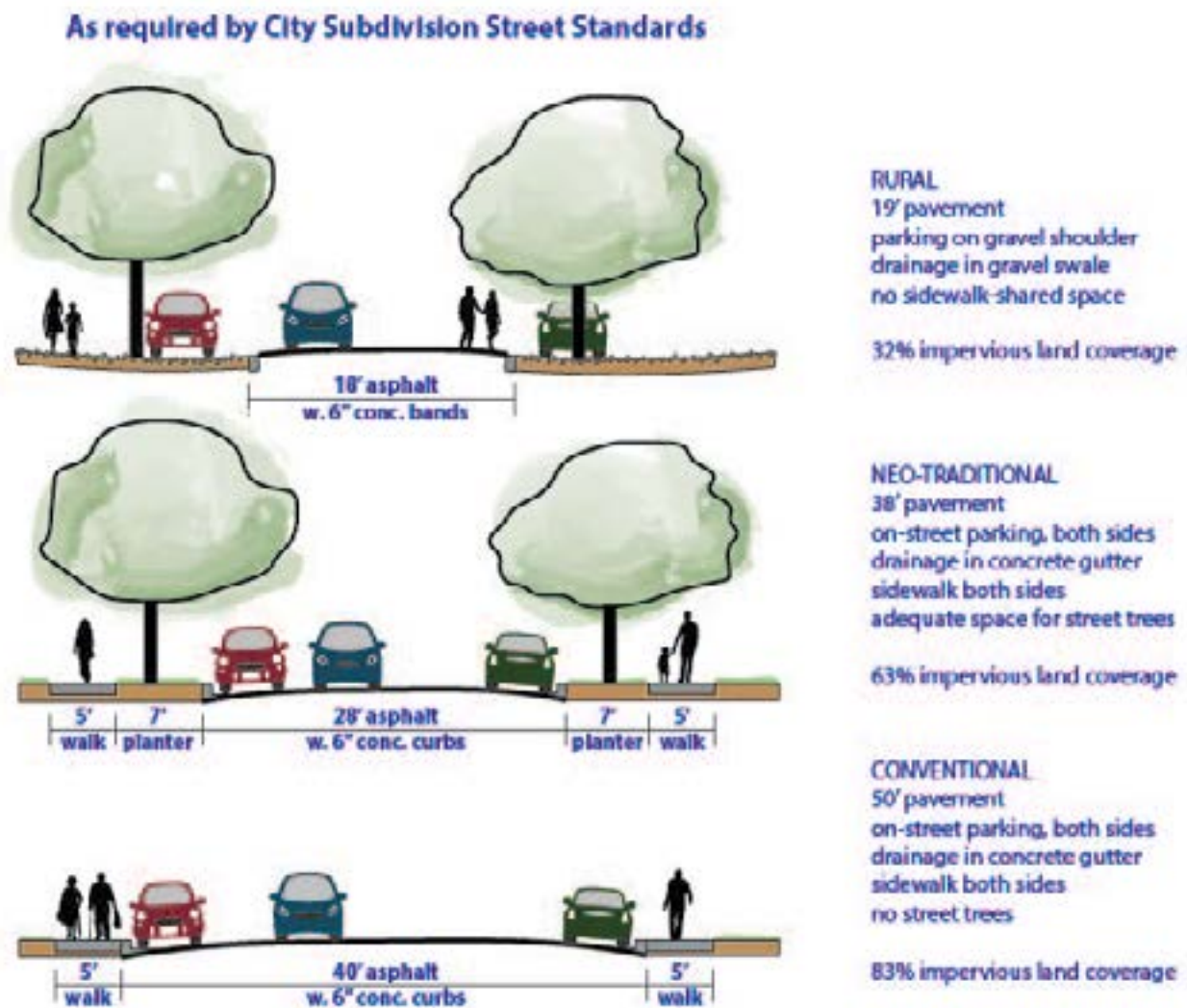

Figure 4.8: Comparison of Street Cross-Section (Two-Way, Residential Access Streets)

4.5. Street Trees

Trees improve water quality by intercepting and storing rainfall on leaves and branch surfaces, thereby reducing runoff volumes and delaying the onset of peak flows. A single street tree can have a total leaf surface area of several hundred to several thousand sq-ft, depending on species and size. This aboveground surface area created by trees and other plants greatly contributes to the water holding capacity of the land. They attenuate conveyance by increasing the soil's capacity to filter rainwater and reduce overland flow rates. By diminishing the impact of raindrops on un-vegetated soil, trees reduce soil erosion. Street trees also have the ability to reduce ambient temperature of storm water runoff and absorb surface water pollutants.

4.6. Parking Lots

In any development, storage space for stationary vehicles can consume many acres of land area, often greater than the area covered by streets or rooftops. In a neighborhood of single-family homes, this parking area is generally located on private driveways or along the street. In higher density residential developments, parking is often consolidated in parking lots.

The space for storage of the automobile, the standard parking stall, occupies only 160 sq-ft, but when combined with aisles, driveways, curbs, overhang space, and median islands, a parking lot can require up to 400 sq-ft per vehicle, or nearly one acre per 100 cars. Since parking is usually accommodated on an asphalt or concrete surface with conventional underground storm drain systems, parking lots typically generate a great deal of DCIA.

There are many ways to both reduce the impervious land coverage of parking areas and to filter runoff before it reaches the storm drain system.

4.6.1. Hybrid Parking Lots

Hybrid lots work on the principle that pavement use differs between aisles and stalls. Aisles must be designed for speeds between 10 and 20 miles per hour (mph), and durable enough to support the concentrated traffic of all vehicles using the lot. The stalls, on the other hand, need only be designed for the 2 or 3 mph speed of vehicles maneuvering into place. Most of the time the stalls are in use, vehicles are stationary. Hybrid lots reduce impervious surface coverage in parking areas by differentiating the paving between aisles and stalls, and combining impervious aisles with permeable stalls, as shown in **Figures 4.9 and 4.10**.

If aisles are constructed of a more conventional, impermeable material suitable for heavier vehicle use, such as asphalt, stalls can be constructed of permeable pavement. This can reduce the overall impervious surface coverage of a typical double loaded parking lot by 60% and avoid the need for an underground drainage system.

Permeable stalls can be constructed of a number of materials including pervious concrete, unit pavers such as brick or stone spaced to expose a permeable joint and set on a permeable base, crushed aggregate, porous asphalt, turf block, and cobbles in low traffic areas. Turf blocks and permeable joints are shown in **Figures 4.11 and 4.12**.

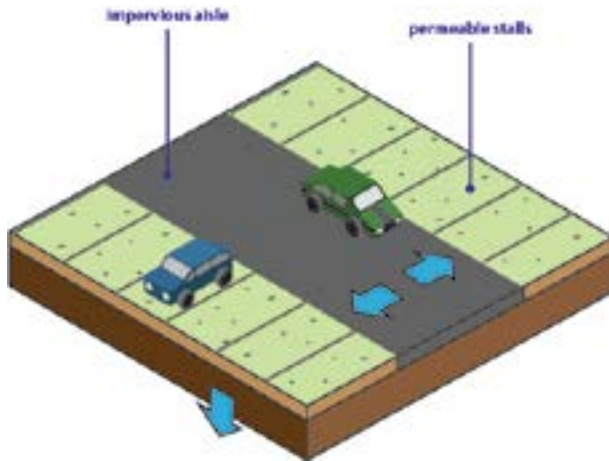

Figure 4.9: Hybrid Parking Lot



Figure 4.10: Hybrid Parking Lot (Honolulu, HI)

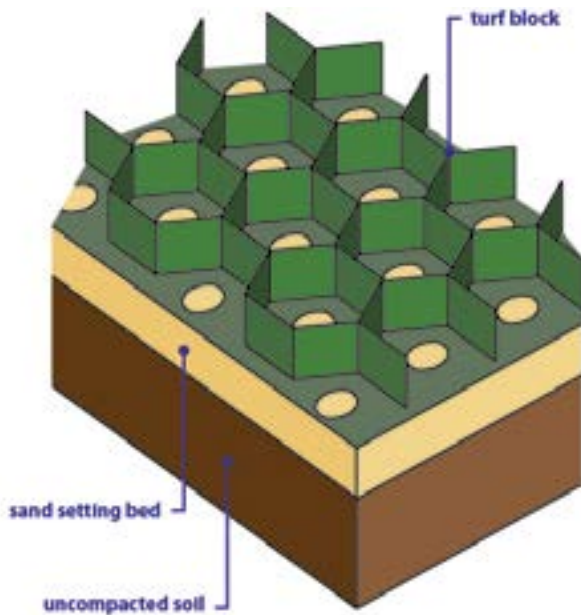

Figure 4.11: Turf Blocks

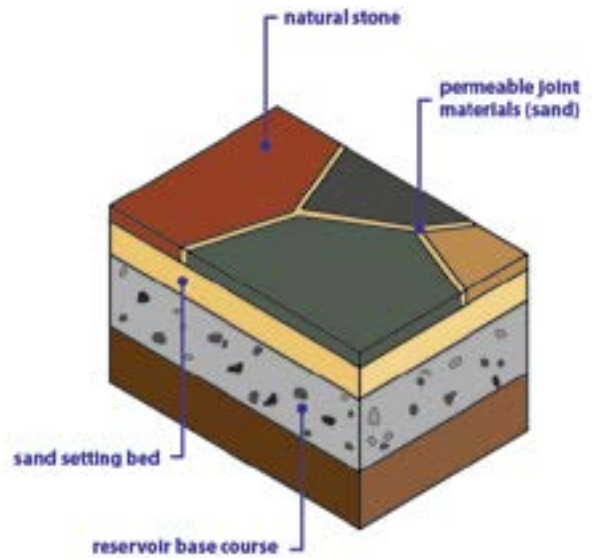

Figure 4.12: Permeable Joints

4.6.2. Parking Grove

A variation on the permeable stall design, a grid of trees and bollards can be used to delineate parking stalls and create a “parking grove.” If the bollard and tree grids are spaced approximately 19 ft apart, two (2) vehicles can park between each row of the grid. This 9.5 ft stall spacing is slightly more generous than the standard 8.5 to 9 ft stall, and allows for the added width of the tree trunks and bollards. A benefit of this design is that the parking grove not only shades parked cars, but also presents an attractive open space when cars are absent. Examples of parking groves are shown in **Figures 4.13 and 4.14**.

4.6.3. Overflow Parking

Parking lot design is often required to accommodate peak demand, generating a high proportion of impervious land coverage of very limited usefulness. An alternative is to differentiate between regular and peak parking demands, and to construct the peak parking stalls of a different, more permeable, material. This “overflow parking” area can be made of a turf block, which appears as a green lawn when not occupied by vehicles, or crushed stone or other materials (see **Figure 4.15**). The same concept can be applied to areas with temporary parking needs, such as emergency access routes, or in residential applications, recreational vehicle (RV), or trailer parking.



Figure 4.13: Parking Grove 1



Figure 4.14: Parking Grove 2



Figure 4.15: Overflow Parking

4.6.4. Porous Pavement with Subsurface Infiltration

In some cases, parking lots can be designed to perform more complex storm water management functions. Constructing a stone-filled reservoir below the pavement surface and directing runoff underground by means of perforated distribution pipes can achieve subsurface storm water storage and infiltration as shown in **Figure 4.16**. Subsurface infiltration basins eliminate the possibilities of mud, mosquitoes and safety hazards sometimes perceived to be associated with ephemeral surface drainage. They also can provide for storage of large volumes of runoff, and can be incorporated with roof runoff collection systems.

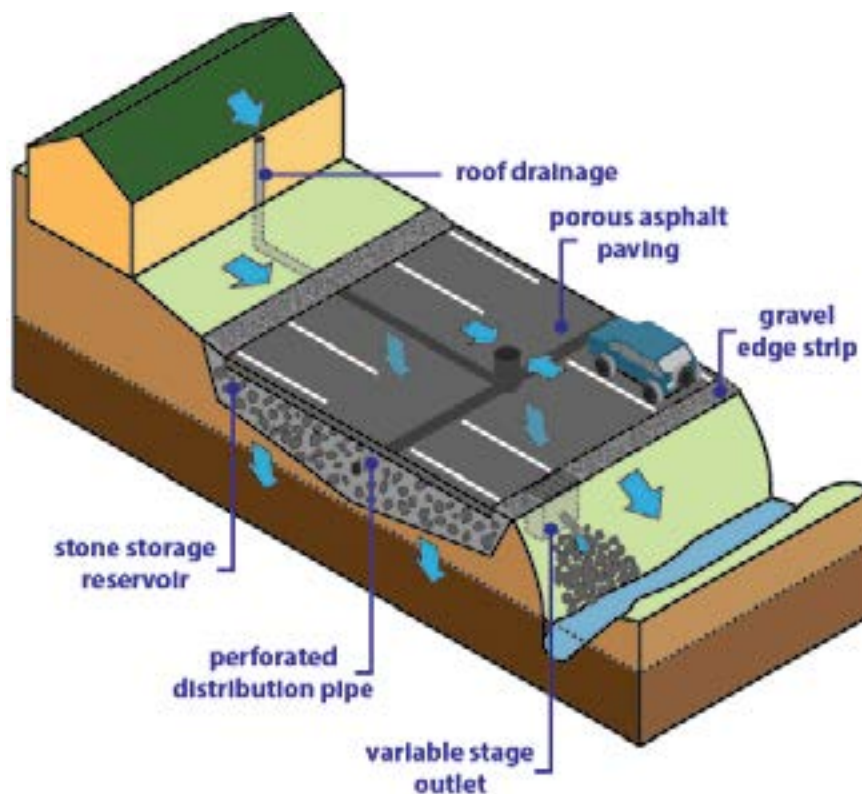

Figure 4.16: Subsurface Infiltration System

4.7. Driveways

Driveways can comprise up to 40% of the total transportation network in a conventional development, with streets, turn-arounds, and sidewalks comprising the remaining 60%.

Driveway length is generally determined by garage setback requirements and width by city codes and land use ordinances. Driveways to City streets shall have a minimum width of 12 ft excluding flares (reference: City Standard Details for Public Works Construction). If garages are setback from the street, long driveways are required, unless a rear alley system is included to provide garage access. If parking for two vehicles side by side is required, a 20 ft minimum width is required. Thus, if a 20 ft setback and a two-car-wide driveway are required, a minimum of 400 sq-ft of driveway will result, or 4% of a typical 10,000 sq-ft residential lot. If the house itself is compact, and the driveway is long, wide, and paved with an impervious material such as asphalt or concrete, it can become the largest component of impervious land coverage on the lot.

An option to reduce the area dedicated to driveways is to allow for tandem parking (one vehicle in front of another on a narrow driveway). In addition, if shared driveways are permitted, then two (2) or more garages can be accessed by a single driveway, further reducing required land area. Rear alley access to the garage can reduce driveway length, but overall impervious surface coverage may not be reduced if the alleys are paved with impervious materials and the access streets remain designed to conventional city standards.

Alternative solutions that work to reduce the impact of water quality problems associated with impervious land coverage on city streets also work on driveways. Sloping the driveway so that it drains onto an adjacent turf or groundcover area prevents driveways from draining directly to storm drain systems. Use of turf-block or unit pavers on sand creates attractive, low maintenance, permeable driveways that filter storm water (see **Figure 4.17**). Crushed aggregate can serve as a relatively smooth pavement with minimal maintenance as shown in **Figure 4.18**. As shown in **Figure 4.19**, paving only under wheels is a viable, inexpensive design if the driveway is straight between the garage and the street, and repaving temporary parking areas with permeable unit pavers such as brick or stone can significantly reduce the percentage of impervious area devoted to the driveway.

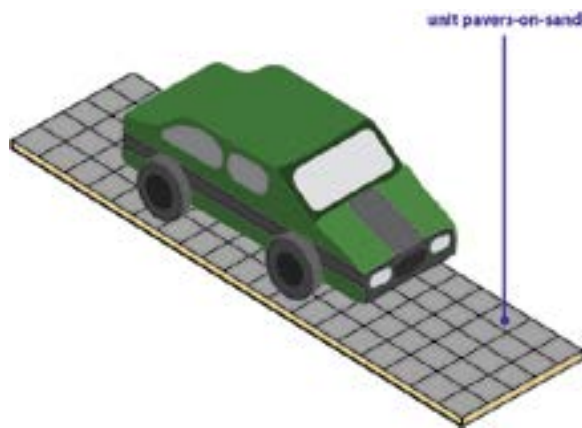

Figure 4.17: Unit Pavers

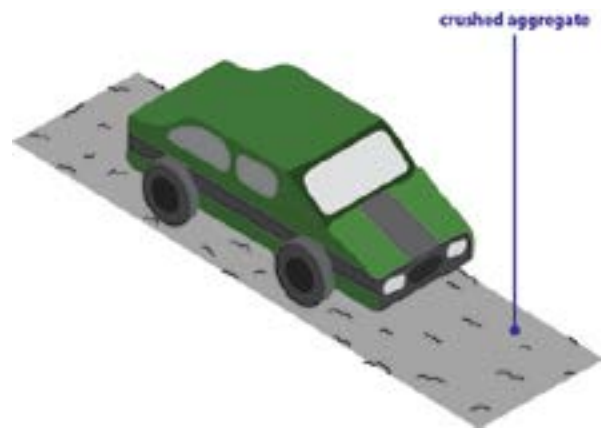

Figure 4.18: Crushed Aggregate

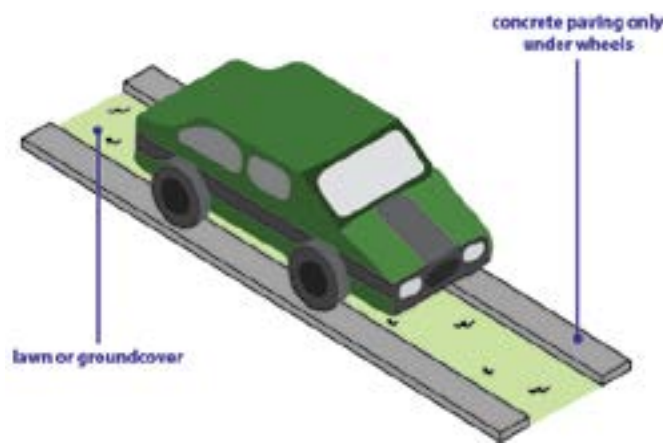

Figure 4.19: Paving only under Wheels

4.8. Landscape and Open Space

In the natural landscape, most soils infiltrate a high percentage of rainwater through a complex web of organic and biological activities that build soil porosity and permeability. Roots reach into the soil and separate particles of clay, insects excavate voids in the soil mass, roots decay leaving networks of macro pores, leaves fall and form a mulch over the soil surface, and earthworms burrow and ingest organic detritus to create richer, more porous soil. These are just a few examples of the natural processes that occur within the soil.

Maintenance of a healthy soil structure through the practice of retaining or restoring native soils where possible and using soil amendments where appropriate can improve the land's ability to filter and slowly release storm water into drainage networks. Construction practices such as decreasing soil compaction, storing topsoil on-site for use after construction, and chipping wood for mulch as it is cleared for the land can improve soil quality and help maintain healthy watersheds. Practices that reduce erosion and help retain water on-site include incorporating organic amendments into disturbed soils after construction, retaining native vegetation, and covering soil during revegetation.

Subtle changes in grading can also improve infiltration. Landscape surfaces are conventionally graded to have a slight convex slope. This causes water to run off a central high point into a surrounding drainage system, creating increased runoff. If a landscape surface is graded to have a slightly concave slope, it will hold water. The infiltration value of concave vegetated surfaces is greater in permeable soils. Soils of heavy clay or underlain with hardpan provide less infiltration value. In these cases, concave vegetated surfaces must be designed as retention/detention basins, with proper outlets or under drains to an interconnected system.

4.9. Multiple Small Basins

Biofiltration, infiltration, and retention/detention basins are the basic elements of a landscape designed for storm water management. The challenge for designers is to integrate these elements creatively and attractively in the landscape – either within a conventional landscape aesthetic or by presenting a different landscape image that emphasizes the role of water and drainage.

Multiple small basins can provide a great deal of water storage and infiltration capacity. These small basins can fit into the parkway planting strip or shoulders of street rights-of-way. If connected by culverts under walks and driveways, they can create a continuous linear infiltration system. Infiltration and retention/detention basins can be placed under wood decks, in parking lot planter islands, and at roof downspouts. Outdoor patios or seating areas can be sunken a few steps, paved with a permeable pavement such as flagstone or gravel, and designed to hold a few inches of water collected from surrounding rooftops or paved areas for a few hours after a rain.

All of these are examples of small basins that can store water for a brief period, allowing it to infiltrate into the soil, slowing its release into the drainage network, and filtering pollutants. An ordinary lawn can be designed to hold a few inches of water for a few hours after a storm, attracting birds and creating a landscape of diversity. Grass/vegetated swales can be integrated with landscaping, providing an attractive, low maintenance, linear biofilter. Extended detention basins (dry ponds) store water during storms, holding runoff to predevelopment levels. Pollutants settle and are removed from the water column before discharging to streams. Wet ponds serve a similar purpose and can increase property values by providing a significant aesthetic, and passive recreation opportunity.

Plant species selection is critical for proper functioning of infiltration areas. Proper selection of plant materials can improve the infiltration potential of landscape areas. Deep-rooted plants help to build soil porosity. Plant leaf-surface area helps to collect rainwater before it lands on the soil, especially in light rains, increasing the overall water-holding potential of the landscape.

A large number of plant species will survive moist soils or periodic inundation. These plants provide a wide range of choices for planted infiltration/detention basins and drainage swales. Most inundated plants have a higher survival potential on well-drained alluvial soils than on fine textured shallow soils or clays.

4.10. Planning Development Strategies in Practice

The importance of site planning in storm water quality protection is illustrated in the following examples of development strategies: conventional residential subdivision (**Figure 4.20: Alternative 1**), conventional subdivision employing BMPs (**Figure 4.21: Alternative 2**), and a mixed-use transit-oriented development (**Figure 4.22: Alternative 3**). All three (3) examples are intended to accommodate approximately 660 housing units on a 220-acre site adjacent to a stream.

The conventional residential subdivision (**Figure 4.20: Alternative 1**) accommodates 660 single-family homes on individual lots. One-sixth acre lots are accessed by a network of 40 ft wide cul-de-sac streets, with 5 ft sidewalks adjacent to the curb on each side of the street. The street and sidewalks are located within a 60 ft right-of-way, which is covered with a 40 ft wide street and two (2)- 5 ft sidewalks, or 50 ft of pavement, 100% impervious land coverage (streets only), and no room for street trees. No variation exists in housing types (all single-family).

Both the streets and the open space features lack structure or hierarchy. The few direct connections through the neighborhood result in long stretches of overly wide streets that discourage walking.

Conventional development design does not use the recreational or storm water benefits of the available open space and does not respond to natural and topographic features. Preservation of open space is a low priority, and the setback between the development and the stream is minimal. The remaining open space character is remnant space offering residents no stream access or parks. Storm water travels through a 15,000 ft network of drainpipes and in the absence of current permit requirements would discharge untreated runoff directly into the stream. However, applying typical permit requirements, the development would still be required to incorporate runoff treatment for the water quality design volume defined in the local permit or MS4 new development program. For example, if the permit required treatment of the runoff from 0.75 inches of rainfall, the development as planned had an overall percent impervious value of 45%, and the designer was considering the use of an extended detention basin for treatment, this would require a treatment volume of approximately 8.3 acre-ft. Based on typical detention basin design practices, this could result in the need to dedicate approximately 2 to 3 acres of land, or the equivalent of approximately 12 to 18 lots to incorporate the basin into the development near the point where drainage enters the stream. Alternatively, if a watershed master plan for water quality had been adopted in which the development could participate financially, the project would contribute financially based on its required treatment volume and the cost allocation plan for the watershed program.

The hybrid/best practices subdivision (**Figure 4.21: Alternative 2**) illustrates a conventional neighborhood that applies some storm water management practices. This attempt accommodates 660 single-family homes on individual lots. Streets are narrower, with the interior access streets at 28 ft wide, while internal neighborhood collectors are 32 ft wide. All streets have detached sidewalks that accommodate street trees planted between the sidewalk and the curb. This development sets the houses

100 ft back from the stream and offers residents 12 acres of access to open space and parks. The overall imperviousness has been reduced to about 41%, thereby reducing the volume to be treated to approximately 7.5 acre-ft. A detention basin has been created in open space within the development. Nearly 25% of the 13,000 ft network of piped storm water drains to a detention pond.

By employing a hierarchy of narrower streets this neighborhood requires 1,475 sq-ft of street per housing unit, a reduction of 19% relative to the conventional sub-division.

The neo-traditional mixed-use neighborhood is illustrated as Alternative 3 (**Figure 4.22**). This neighborhood includes 660 housing units, but also introduces other uses: retail, office, and live-work, within a network of tree-lined streets and open space. The neighborhood drains to an open space park adjacent to the stream, naturally and efficiently filtering storm water before it enters the stream. Bioswales along key streets capture and treat storm water en-route to the stream, providing aesthetic appeal and recreational opportunities. Alternative 3 requires 965 sq-ft of street per housing unit, a reduction of 47% relative to the conventional sub-division. A strategically located transit system stops near shops and higher density housing makes transit feasible. Every dwelling unit in the neighborhood is within a 5-minute (min) walk from shops or transit. The overall imperviousness of this site has been reduced to approximately 36%, further reducing the treatment volume. In addition, there are a variety of opportunities to incorporate treatment for all of the remaining runoff within the open space park without the need to dedicate any additional developable land.

A comparison of the three (3) alternatives is shown in **Table 4.1**.



Figure 4.20: Alternative 1 - Conventional



Figure 4.21: Alternative 2 - Hybrid/Best Practices



Figure 4.22: Alternative 3 - Neo-Traditional

Table 4.1: Comparison of Three Alternatives

	Alternative 1	Alternative 2	Alternative 3
Total Site (acre)	220	220	220
Number of Housing Units	660	660	660
Parks and Open Space (acre)	0	12	12
Stream Setback (feet)	0	100	500
Impervious Land Coverage - Street (acre)	28	22	15
Percentage of Site that is Impervious - Street only	13%	10%	7%
Percentage of Site that is Impervious - Street only (relative to conventional)	100%	81%	53%
Linear feet of Pipe	15,000	13,000	10,000
Linear feet of Swale	0	0	4,700
Width of Major Streets (feet)	40	32	32
Width of Minor Streets (feet)	None	28	28

Typical lots in Alternatives 2 and 3 are illustrated in three (3) forms: street loaded, alley fed and rural. In the street-loaded form, lot size is still approximately 1/6 acre, but the lot is narrower and deeper, thus reducing the amount of street frontage per household. The two-car garage is accessed from a front driveway. This front-loaded street accounts for 63% impervious land coverage in the 60 ft right-of-way.

Looking at a typical street, the traditional residential neighborhood reduces the number of feet of street and sidewalk per housing unit by nearly 40% compared to the conventional subdivision. This is accomplished by two (2) means: a narrower street width (28 ft versus 40 ft), and narrower, deeper lots (60 ft versus 65 ft wide). Narrower lots mean less street frontage per lot.

In the alley-loaded form, the street right-of-way is narrowed to 50 ft, leaving 4 ft for trees between the sidewalk and curb. This form also employs the narrower street, achieving a 40% reduction in pavement dedicated to street and sidewalk. A 16 ft-wide alley is provided in the back to access a garage at the rear of each lot. Additional pavement for the alley is balanced by elimination of pavement for the front driveway. This model assumes an impervious asphalt or concrete alley. Gravel alleys are feasible, and improve permeability. In this form, narrower, deeper lots are employed to accommodate the depth required for the alley.

The rural street form dramatically reduces impervious land coverage. The street is 19 ft wide with gravel shoulders for trees and parking. Pedestrians walk on the gravel shoulder or share the street with slow-moving cars.

Looking at a typical street, the rural form provides the greatest reduction in impervious land coverage. Only 570 sq-ft of pavement of street is required per housing unit, a reduction of 62% compared to the conventional sub-division.

5. Treatment Control BMP Design

Treatment Control BMPs are engineered technologies designed to remove pollutants from storm water runoff prior to discharge to the storm drain system or receiving waters. This section addresses BMP numeric sizing criteria, guidance for infiltration testing BMPs, and individual BMP fact sheets to support compliance with the *Water Quality Rules*.

5.1. Best Management Practices Selection

5.1.1. Determine Drainage Management Areas

Drainage management areas (DMAs) provide an important framework for feasibility screening, BMP prioritization, and storm water management system configuration. BMP selection, sizing, and feasibility determinations must be made at the DMA level; therefore, delineation of DMAs is highly recommended at the conceptual site planning phase and is mandatory for completing the project design and meeting submittal requirements. This section provides guidance on delineating DMAs that is intended to be used when choosing BMPs.

DMAs are defined based on the proposed drainage patterns of the site and the BMPs to which they drain. During the early phases of the project, DMAs shall be delineated based onsite drainage patterns and possible BMP locations identified in the site planning process. DMAs should not overlap and should be similar with respect to BMP opportunities and feasibility constraints. More than one DMA can drain to the same BMP. However, because the BMP sizes are determined by the runoff from the DMA, a single DMA may not drain to more than one (1) BMP (see **Figure 5.1**).

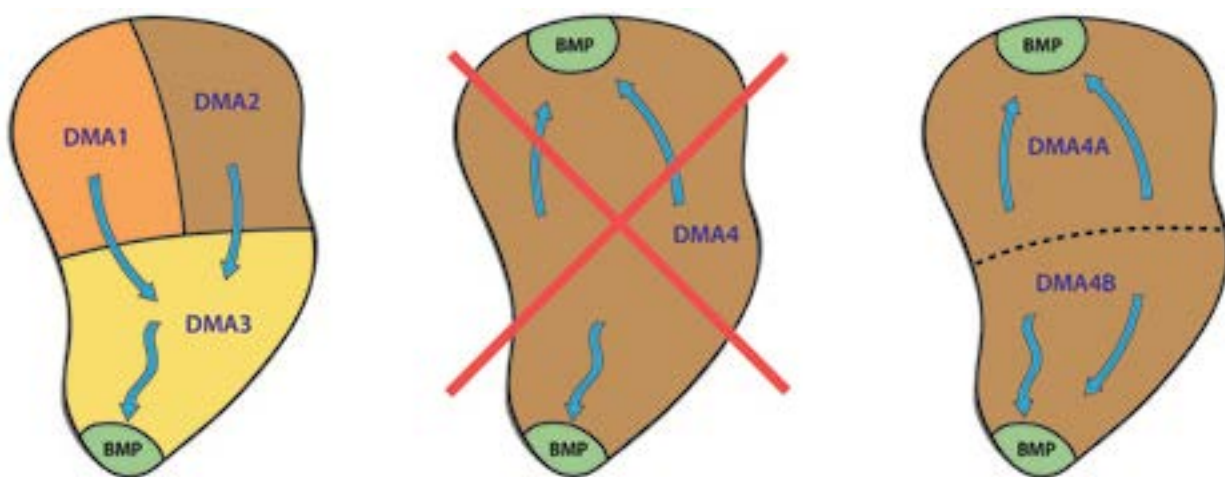

Figure 5.1: DMA Delineation

In some cases, it may be appropriate in early planning phases to generalize the proposed treatment plan by simply assigning a certain BMP type to an entire planning area and calculating the total sizing requirement without identifying the specific BMP locations at that time. This planning area would be later subdivided for design-level calculations.

BMPs must be sized to treat the WQV or Water Quality Flow (WQF) from the total area draining to the BMP, including any offsite or onsite areas that combine with project runoff and drains to the BMP. To minimize offsite flows treated by project BMPs, consider diverting upgradient flows subject to local drainage and flood control regulation.

5.1.2. Evaluate Pollutants of Concern

BMPs selected for each DMA should address anticipated pollutants of concern. Pollutants identified in the USEPA 303(d) list for specific water bodies in Hawaii include metals, nitrogen, nutrients (without specifying nitrogen or phosphorus), indicator bacteria (i.e., fecal coliform), pesticides, and trash. Less commonly cited pollutants include suspended solids, polychlorinated biophenyls (PCBs), and ammonium. With respect to metals, typically, only the general term is used. In some cases, lead is identified.

The BMP plan development process typically includes consideration of:

- Receiving water quality (including pollutants for which receiving waters are listed as impaired under CWA section 303(d)).
- Land use type of the development project and pollutants associated with that land use type.
- Pollutants expected to be present on site.
- Changes in storm water discharge flow rates, velocities, durations, and volumes resulting from the development project.
- Sensitivity of receiving waters to changes in storm water discharge flow rates, velocities, durations, and volumes.

It is important to realize that pollutants of concern for a water body can extend beyond those pollutants listed in the 303(d) list as causing impairment. For example, trash is a pollutant of concern in most communities, yet only a few water bodies are presently listed as impaired by trash. The key is to remember that a pollutant does not need to cause an immediate impairment for it to be considered when developing a BMP Plan.

Table 5.1 summarizes pollutants typically associated with Priority Project land uses and can be used as general guidance when selecting BMPs.

5.1.3. Identify Candidate BMPs

Selecting BMPs based on pollutants of concern is a function of site constraints, constituents of concern, BMP performance, stringency of permit requirements, and watershed specific requirements such as TMDLs. Pollutants of concern are especially important in water limited stream segments and must be carefully reviewed in relationship to BMP performance.

To facilitate comparison of the BMP characteristics and selection, a summary of the BMP categories, expected pollutants, and BMP performance is presented in **Tables 5.2, 5.3 and 5.4**, respectively. Developers shall consider the expected pollutants that could be generated at the site when choosing BMPs.

Table 5.1: Typical Pollutants Associated with Priority Projects

Priority Project Categories	Nutrients	Sediment	Trash	Pathogens	Pesticides	Oil & Grease	Metals	Organic Compounds
Priority A: Residential Development > one acre	X	X	X	X	X	X		
Priority A: Commercial Development >one acre	P ⁽¹⁾	P ⁽¹⁾	X	P ⁽³⁾	P ⁽⁵⁾	X	X	P ⁽²⁾
Priority B: Industrial		X	X			X	X	X
Priority B: Automotive Repair Shops			X			X	X	X ⁽⁴⁾⁽⁵⁾
Priority B: Restaurants			X	X	P ⁽¹⁾	X		
Priority B: Parking Lots	P ⁽¹⁾	P ⁽¹⁾	X		P ⁽¹⁾	X	X	
Priority B: Retail Gasoline Outlets			X			X	X	X
Priority B: Buildings taller than 100 ft in height	X	X	X	X	X	X		
(All) Streets, Highways & Freeways	P ⁽¹⁾	X	X	X	P ⁽¹⁾	X	X	X ⁽⁴⁾
X = anticipated P = potential (1) A potential pollutant if landscaping exists onsite. (2) A potential pollutant if the project includes uncovered parking areas. (3) A potential pollutant if land use involves food or animal waste products. (4) Including petroleum hydrocarbons. (5) Including Solvents								

Table 5.2: Treatment Control BMP Categories

BMP	Retention	Biofiltration	Other
Infiltration Basin	✓		
Infiltration Trench	✓		
Subsurface Infiltration	✓		
Dry Well	✓		
Bioretention Basin	✓		
Permeable Pavement	✓		
Harvesting/Reuse	✓		
Green Roof		✓	
Vegetated Bio-filter ¹		✓	
Enhanced Swale		✓	
Downspout Disconnection		✓	
Vegetated Swale		✓	
Vegetated Buffer Strip		✓	
Detention Basin			✓
Manufactured Treatment Device			✓
Sand Filter			✓
¹ Includes both proprietary and non-proprietary systems.			

Table 5.3: Treatment Control BMP Expected Pollutant Removals

Priority Project Categories	Nutrients	Sediment	Trash	Pathogens	Pesticides	Oil & Grease	Metals	Organic Compounds
Infiltration Basin	H	H	H	H	H	H	H	H
Infiltration Trench	H	H	H	H	H	H	H	H
Subsurface Infiltration	H	H	H	H	H	H	H	H
Dry Well	H	H	H	H	H	H	H	H
Bioretention Basin	H	H	H	H	H	H	H	H
Permeable Pavement	H	H	L	H	H	H	H	H
Green Roof	M	H	H	M	M	H	M	M
Vegetated Bio-Filter	M	H	H	M	U	H	H	H
Enhanced Swale	M	H	H	U	U	M	M	U
Vegetated Swale	L	M	L	L	U	M	M	U
Vegetated Buffer Strip	L	M	M	L	U	M	M	M
Manufactured Tree Filter	M	H	H	M	U	H	H	H
Harvesting/Reuse	H	H	L	H	H	H	H	H
Detention Basin	L	M	H	L	U	M	L/M	U
Manufactured Treatment Device	L	M/H	H	L	L	M/H	L	L
Sand Filter	L/M	H	H	M	U	H	M/H	M/H

H = High, M = Medium, L = Low, U = Unknown

By using BMPs that are applicable and feasible, the project can achieve benefits of these practices, while not incurring unnecessary expenses (associated with using practices that do not apply or would not be effective) or creating undesirable conditions (for example, infiltration-related issues, vector concerns including mosquito breeding, etc.).

For example, on Oahu, many high-density, ultra-urban districts are in tidally influenced coastal areas and frequently encounter high ground water where infiltration may not be feasible. These projects would most typically fall into the redevelopment category rather than new development, which presents additional challenges with space constraints and soil quality. In these cases, Developers are encouraged to utilize multiple BMPs in combination or series to meet the LID retention and treatment criteria. While infiltration may not be possible, the Rules prioritize harvest and reuse systems to capture roof runoff and use the water onsite. For the remaining runoff, biofiltration BMPs can be integrated into the overall facility landscaping which may include green roofs, aboveground planter boxes, and tree box filters. Configuration of these BMPs as either aboveground systems or with shallow footprints can overcome the challenges associated with high ground water levels so that underdrain inverts are compatible with the surrounding drainage infrastructure.

Table 5.4 presents several development types and BMPs that are generally appropriate to meet the requirements of the *Water Quality Rules* for the various priority project types.

Table 5.4: Recommended Selection of Permanent BMPs

Priority	Development Type	Infiltration	Permeable Pavement ¹	Green Roof	Bio-filtration	Harvest/Reuse	Manufactured Treatment Device	Source Control
A	Single Family Residential	H	H	NR ¹	H	M	H	H
	Commercial/Institutional/Mixed Use	H	H	M ¹	H	H	H	H
	Parks and Open Space	H	H	N/A	H	N/A	M	N/A
A or B	High Density/Ultra-urban, Buildings Greater than 100 feet tall, Retail Malls	M ²	H	H	H	H	H	H
A or B	Parking Lots	H	H	N/A	H	N/A	H	H
B	Industrial, Automotive Repair Shops, Restaurants, Retail Gasoline Outlets	M ³	M ³	M	H	M	H	H

H= Highly Appropriate; M= May be Appropriate; NR= Not Recommended; N/A= Not Applicable
1. Green roofs are not recommended for single family homes.
2. High density/ultra-urban redevelopment projects may frequently encounter space constraints and high ground water levels which may limit the appropriateness or feasibility of infiltration BMPs.
3. Infiltration BMPs are not recommended for areas with high potential for concentrated pollutants or chemical spills. Source Control BMPs should be implemented in those areas.

5.1.4. Consider Operation and Maintenance Requirements

Once BMPs have been selected based on performance and appropriateness for site conditions, both installation cost and operation and maintenance cost can become an important differentiator in BMP selection. Treatment Control BMP costs vary depending on the type of BMP installed. **Table 5.5** shows maintenance costs compiled by the County of San Diego which looked at the maintenance time and costs for large, medium, and small BMPs. In general, the more time consuming maintenance resulted in higher costs. While permanent BMP maintenance is the responsibility of the owner, the City recommends that BMPs be chosen with consideration to maintenance requirements when possible. For instance, underground vault-type devices may provide valuable space savings, but there are concerns that regular maintenance will not be provided, as well as the worker safety and public safety risks presented during maintenance activities.

Table 5.5: Summary of Operation and Maintenance Effort for BMPs

BMP	Small BMP		Medium BMP		Large BMP	
	Annual Hours	Annual Cost	Annual Hours	Annual Cost	Annual Hours	Annual Cost
Bioretention Area	32.0	\$ 3,174	44.0	\$ 4,078	68.0	\$ 5,877
Flow-Through Planter	24.0	\$ 2,367	30.0	\$ 2,882	42.0	\$ 3,781
Cistern With Bioretention	33.2	\$ 3,186	38.2	\$ 3,505	48.2	\$ 4,255
Dry Detention Basin with Grass/ Vegetated Lining	25.8	\$ 2,433	32.6	\$ 3,204	53.0	\$ 4,734

Source: San Diego Stormwater Urban Mitigation Plan website: http://www.sandiegocounty.gov/content/dam/sdc/dpw/WATERSHED_PROTECTION_PROGRAM/susmppdf/bmp_om_cost_2012.xlsx. Costs in Hawaii may be higher.

Table 5.5: Summary of Operation and Maintenance Effort for BMPs (Continued)

BMP	Small BMP		Medium BMP		Large BMP	
	Annual Hours	Annual Cost	Annual Hours	Annual Cost	Annual Hours	Annual Cost
Dry Detention Basin with Impervious Lining	15.8	\$ 1,412	20.6	\$ 2,067	35.0	\$ 3,147
Underground Vault	19.8	\$ 1,819	24.6	\$ 2,418	39.0	\$ 3,498
Cistern	15.2	\$ 1,423	17.2	\$ 1,830	23.2	\$ 2,280
Infiltration Basin	28.6	\$ 2,679	33.0	\$ 3,297	46.2	\$ 4,287
Infiltration Trench	17.8	\$ 1,564	25.0	\$ 2,418	46.6	\$ 4,037
Wet Pond/Basin (Permanent Pool)	113.8	\$ 10,037	214.6	\$ 17,081	517.0	\$ 39,752
Constructed Wetland	109.8	\$ 9,708	210.6	\$ 16,763	513.0	\$ 39,433
Vegetated Swale	15.3	\$ 1,476	20.9	\$ 2,203	26.5	\$ 2,623
Austin Sand Filter	19.6	\$ 1,712	24.4	\$ 2,374	38.8	\$ 3,454
Delaware Sand Filter	19.6	\$ 1,712	24.4	\$ 2,374	38.8	\$ 3,454
Multi-Chambered Treatment Train	27.9	\$ 2,587	32.7	\$ 3,114	47.1	\$ 4,194
Tree-Pit-Style Unit	15.6	\$ 1,491	15.6	\$ 1,491	15.6	\$ 1,491
Vault Based Filtration with Replaceable Cartridges	23.8	\$ 2,050	28.6	\$ 2,690	43.0	\$ 3,769
Swirl Concentrator	15.0	\$ 2,062	15.0	\$ 2,062	15.0	\$ 2,062
Catch Basin Insert	15.0	\$ 1,493	15.0	\$ 1,493	15.0	\$ 1,493
Catch Basin Insert with Hydrocarbon Boom	17.0	\$ 1,707	17.0	\$ 1,707	17.0	\$ 1,707
Permeable Pavements	7.8	\$ 808	13.6	\$ 1,206	23.2	\$ 1,926
Self-Retaining	6.8	\$ 598	6.8	\$ 598	6.8	\$ 598
Vegetated Roof	17.0	\$ 1,975	21.0	\$ 2,252	33.0	\$ 3,152

Source: San Diego Stormwater Urban Mitigation Plan website: http://www.sandiegocounty.gov/content/dam/sdc/dpw/WATERSHED_PROTECTION_PROGRAM/susmppdf/bmp_om_cost_2012.xlsx. Costs in Hawaii may be higher.

For the purpose of this document, the average annual maintenance time for a BMP device used to determine the Maintenance Ranks are defined in **Table 5.6**. These maintenance ranks are specified on each treatment control fact sheet (**Appendix B**).

Table 5.6: Maintenance Rank Definition

Maintenance Rank	Definition
Low	BMPs with an average maintenance requirement of less than 25 hours per year.
Medium	BMPs with an average maintenance requirement of between 25 and 50 hours per year.
High	BMPS with an average maintenance requirement of over 50 hours per year.

Long-term O&M guidelines are presented in Section 7.

5.1.5. *Other Considerations*

Vector Breeding Considerations

The potential of a BMP to create vector breeding habitat and/or harborage should also be considered when selecting BMPs. Mosquito and other vector production is a nuisance and public health threat.

Mosquitoes can breed in standing water almost immediately following a BMP installation and may persist at unnaturally high levels and for longer seasonal periods in created habitats. BMP siting, design, construction, and maintenance must be considered in order to select a BMP that is least conducive to providing habitat for vectors. Tips for minimizing vector-breeding problems in the design and maintenance of BMPs are presented in the BMP fact sheets. Certain BMPs, including ponds and wetlands and those designed with permanent water sumps, vaults, and/or catch basins (including below ground installations), may require routine inspections and treatments.

Threatened and Endangered Species Considerations

The presence or potential presence of threatened and endangered species should also be considered when selecting BMPs. Although preservation of threatened endangered species is crucial, treatment BMPs are not intended to supplement or replace species habitat except under special circumstances. The presence of threatened or endangered species can hinder timely and routine maintenance, which in turn can result in reduced BMP performance and an increase in vector production. In extreme cases, rights to the treatment BMP and surrounding land may be lost if threatened or endangered species utilize or become established in the BMP.

When considering BMPs where there is a presence or potential presence of threatened or endangered species, early coordination with DLNR and USFWS is essential. During this coordination, the purpose and the long-term operation and maintenance requirements of the BMPs need to be clearly established through written agreements or memorandums of understanding. Absent firm agreements or understandings, proceeding with BMPs under these circumstances is not recommended.

5.2. Numeric Sizing Criteria

Based on the selected BMPs, the capacity and primary design sizing criteria must be established using a combination of local hydrology, project drainage characteristics (i.e., percent imperviousness or runoff coefficient), and numerical sizing requirements. BMPs will be volume-based, flow-based, or demand-based, and must be able to effectively treat the design quantity. Peak storm event flows must also be taken into account if the BMP is a flow-based BMP, or a volume-based BMP that must also safely pass the design storm (i.e., an in-line detention basin).

This section presents the methodology for calculating the WQV and WQF Rate, which are used to size the majority of the Treatment Control BMPs. Calculations for the WQV and WQF should not include DMAs that are considered Self-Mitigating (refer to Site Design Strategies).

5.2.1. *Volume-Based Best Management Practice Design*

Volume-based BMP design standards apply to BMPs whose primary mode of pollutant removal depends on the volumetric capacity of the BMP. Examples of BMPs in this category include detention basins, retention basins, and infiltration. Typically, a volume-based BMP design criteria calls for the capture and infiltration or treatment of a certain percentage of the runoff from the project site.

The WQV is calculated using the following equation:

$$WQV = PCA \times 3630$$

Where WQV = Water Quality Design Volume [cubic feet (cu-ft)]
 P = Design Storm Runoff Depth (in)
 C = Volumetric Runoff Coefficient
 A = Tributary Drainage Area (acres)

As specified in the *Water Quality Rules*, a design storm runoff depth of 1 inch shall be used for LID retention BMPs and 1.5 inches shall be used for all treat and release BMPs including LID biofiltration and alternative compliance BMPs. In previous analysis, the City determined that the 1-inch design storm was equal to or exceeded the 24-hr 85th percentile storm for most of Oahu.

The volumetric runoff coefficient shall be calculated using the following equation as developed by USEPA for smaller storms in urban areas:

$$C = 0.05 + 0.009I$$

Where C = Volumetric Runoff Coefficient
 I = Percent of Impervious Cover (percent)

A graph presenting the relationship between the percent of impervious cover and the unit water quality design volume for a 1-inch and 1.5-inch runoff depth is shown in **Figure 5.2**.

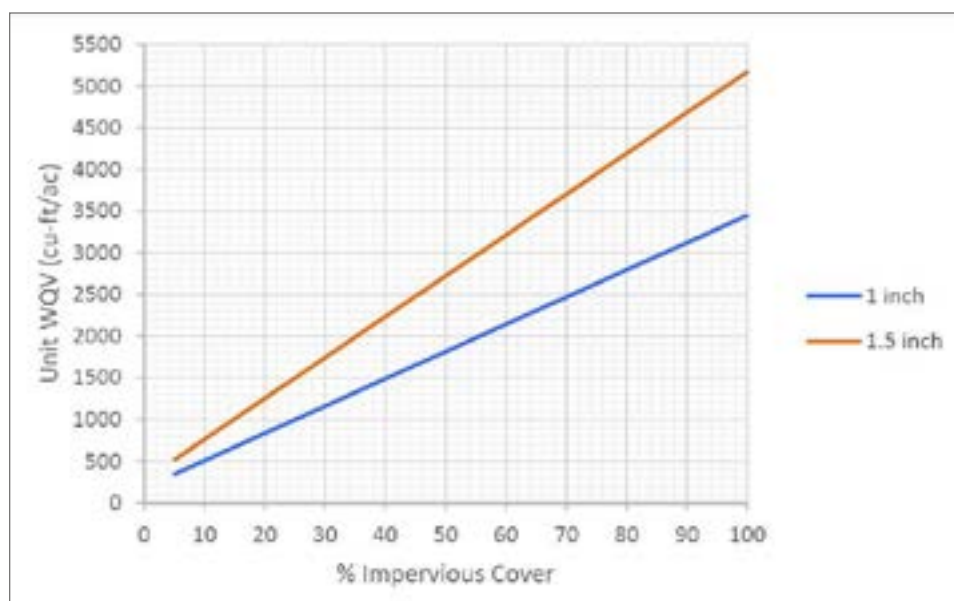

Figure 5.2: Unit Water Quality Volume for 1 and 1.5 inch Runoff Depth

5.2.2. Flow-Based BMP Design

Flow-based BMP design standards apply to BMPs whose primary mode of pollutant removal depends on the rate of flow of runoff through the BMP. Examples of BMPs in this category include swales, screening devices, and many proprietary products. Typically, flow-based BMP design criteria calls for the capture and infiltration or treatment of the flow runoff produced by rain events of a specified magnitude.

The design WQF rate is calculated using the Rational Formula:

$$WQF = 1.5 \times CiA$$

Where WQF = Water Quality Design Flow Rate (cu-ft/sec)
 C = Runoff Coefficient
 i = Peak Rainfall Intensity (in/hr)
 A = Tributary Drainage Area (acres)

As specified in the *Water Quality Rules*, a peak rainfall intensity of 0.4 inches per hour shall be used. The runoff coefficient shall be determined from **Table 5.7**. For drainage areas containing multiple land uses, the following formula may be used to compute a composite weighted runoff coefficient:

$$C_c = \left(\sum_{i=1}^n C_i A_i \right) / A_t$$

Where C_c = Composite Weighted Runoff Coefficient
 $C_{1,2,..n}$ = Runoff Coefficient for each Land Use Cover Type
 $A_{1,2,..n}$ = Drainage Area to each Land Use Cover Type (acres)
 A_t = Total Drainage Area (acres)

Table 5.7: Runoff Coefficients for Water Quality Flow Calculations

Type of Drainage Area	Runoff Coefficient		Type of Drainage Area	Runoff Coefficient
Roofs	0.90		Permeable interlocking concrete pavement	0.10
Concrete	0.80		Grid pavements with grass or aggregate surface	0.10
Stone, brick, or concrete pavers with mortared joints and bedding	0.80		Crushed aggregate	0.10
Asphalt	0.70		Grass	0.10
Stone, brick, or concrete pavers with sand joints and bedding	0.70		Grass over Porous Plastic	0.05
Pervious Concrete	0.10		Gravel over Porous Plastic	0.05
Porous asphalt	0.10			
Note that these C-factors are only appropriate for small storm treatment design and are not appropriate for flood control facilities.				

A graph presenting the relationship between the weighted runoff coefficient and the unit water quality design flow rate is shown in **Figure 5.3**.

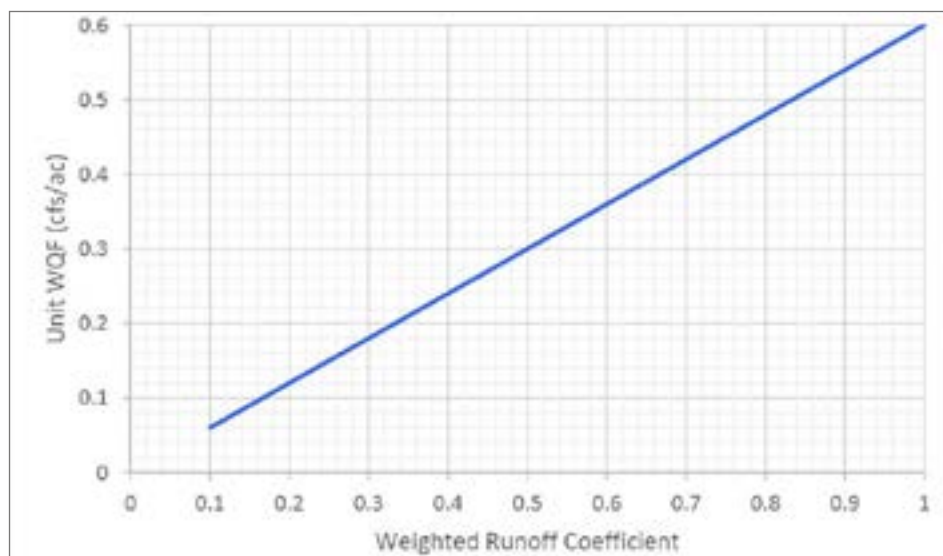

Figure 5.3: Unit Water Quality Flow

5.2.3. Combined Volume-Based and Flow-Based BMP Design

Volume-based BMPs and flow-based BMPs do not necessarily treat precisely the same storm water runoff. For example, an on-line volume-based BMP such as a detention basin will treat the design runoff volume and is essentially unaffected by runoff entering the basin at an extremely high rate, say from a very short, but intense storm that produces the design volume of runoff. However, a flow-based BMP might be overwhelmed by the same short, but intense storm if the storm intensity results in runoff rates that exceed the flow-based BMP design flow rate. By contrast, a flow-based BMP such as a swale will treat the design flow rate of runoff and is essentially unaffected by the duration of the design flow, say from a long, low intensity storm. However, a volume-based detention basin subjected to this same rainfall land runoff event will begin to provide less treatment or will go into bypass or overflow mode after the design runoff volume is delivered.

Therefore, there may be some situations where designers need to consider both volume-based and flow based BMP design criteria. An example of where both types of criteria might apply is an off-line detention basin. For an off-line detention basin, the capacity of the diversion structure could be designed to comply with the flow-based BMP design criteria while the detention basin itself could be designed to comply with the volume-based criteria.

When both volume-based and flow based criteria apply, the designer should determine which of the criteria apply to each element of the BMP system, and then size the elements accordingly.

5.3. Infiltration Requirements

LID Retention BMPs rely on the soil's ability to infiltrate storm water runoff. This section outlines the design requirements applicable to all infiltration facilities.

5.3.1. Soil Types and Textures

The soil types within the subsoil profile, extending a minimum of 3 ft below the bottom of the proposed facility, should be identified to verify the infiltration rate or permeability of the soil. The infiltration

rate, or permeability, measured in inches per hour, is the rate at which water passes through the soil profile during saturated conditions. Although the units of infiltration rate and hydraulic conductivity of soils are similar, there is a distinct difference between these two (2) quantities. They cannot be directly related unless the hydraulic boundary conditions are known, such as hydraulic gradient and the extent of lateral flow of water, or can be reliably estimated. Minimum and maximum infiltration rates establish the suitability of various soil textural classes for infiltration. Each soil texture and corresponding hydrologic properties within the soil profile are identified through analysis of a gradation test of the soil boring material. **Table 5.8** presents a list of the infiltration rates for the soil textures of the U.S. Department of Agriculture (USDA) Textural Triangle, presented in **Figure 5.4**.

Table 5.8: Typical Soil Infiltration Rates^a

Texture Class	Hydrologic Soil Group	Infiltration Rate (inches/hour)
Sand	A	8.00
Loamy Sand	A	2.00
Sandy Loam	B	1.00
Loam	B	0.50
Silt Loam	C	0.25
Sandy Clay Loam	C	0.15
Clay Loam	D	0.09
Silt Clay Loam	D	< 0.09
Clay	D	< 0.05

a - Source: ASCE, 1998



Figure 5.4: USDA Soils Textural Triangle

Soil textures acceptable for use with infiltration systems include those with infiltration rates equal to or above 0.50 inches per hour (a soil texture indicative of loam). Soil textures with rates less than 0.50 inches per hour are not suitable as it increases the risk of the BMP not draining properly and creating localized areas of standing water. It is important to note however, that Hydrologic Soil Group (HSG) “D” soils (e.g., clay loam, silty clay loam, and silty clay) in Oahu have been shown to perform better than their counterparts in the Continental United States. As a result, locations with HSG “D” soils should not be automatically rejected as candidate sites for infiltration BMPs without the opinion of a licensed professional engineer with geotechnical expertise.

5.3.2. *Field Investigations*

According to the *Water Quality Rules*, infiltration can be considered infeasible if the soil at the site is HSG “C” or “D,” or if the infiltration rate is less than 0.5 in/hr. For HSG “A” and “B” soils, and those sites who wish to use infiltration even with HSG C or D soils, soil investigations and infiltration tests are required for infiltration facilities to accurately determine the local soil characteristics and capacity for infiltration.

Soil Lithology and Depth to Groundwater

An initial soil investigation is recommended to adequately evaluate soil lithology and determine if there are potential problems in the soil structure that would inhibit the rate or quantity of infiltration desired; or if there are potential adverse impacts to structures, slopes or groundwater that could result from locating the device nearby.

Geotechnical test pits or borings should be dug to a minimum of 5 ft deep below the proposed device invert, or as determined by the licensed professional engineer with geotechnical expertise. A test pit allows visual observation of the soil horizons and overall soil conditions both horizontally and vertically in that portion of the site. Although the use of soil borings is permitted at the recommendation of a geotechnical professional, it is discouraged as a substitute for test pits as visual observation is narrowly limited in a soil boring and the soil horizons cannot be observed in-situ, but must be observed from the extracted borings.

The soil profiles should be carefully logged to determine variations in the subsurface profile. Samples should be collected from the soil profiles at different horizons and transported to a laboratory for soil indices testing, plasticity, and chemical testing. In addition, the test pits or samples from borings should be examined for other characteristics that may adversely affect infiltration. These include evidence of significant mottling (indicative of high groundwater), restrictive layer(s), and significant variation in soil types, either horizontally or vertically.

An initial indication of the seasonal high groundwater water table elevation should be determined by using a piezometer or other accepted geotechnical means. The piezometer should be installed to a depth of at least 20 ft below the proposed device invert using the direct push or other suitable method. Initial groundwater levels shall be recorded at least 24 hrs after installation. The geotechnical professional will make a determination whether the groundwater elevation determined after 24 hrs can be considered to be a reasonable indication of the seasonal high water table for the site.

Permeability Testing

Infiltration rate tests are used to help estimate the maximum sub-surface vertical infiltration rate of the soil below a proposed infiltration facility (e.g., infiltration trench or infiltration basin). The tests are intended

to simulate the physical process that will occur when the facility is in operation; therefore a saturation period is required to approximate the soil moisture conditions that may exist prior to the onset of a runoff event. Laboratory tests are strongly discouraged, as a homogeneous laboratory sample does not represent field conditions. Infiltration tests should be conducted in the field. Tests should not be conducted in the rain or within 24 hrs of significant rainfall events (greater than 0.5 inches).

There are a variety of infiltration field test methodologies to determine the infiltration rate of a soil, the two most coming being the Falling Head Percolation Test and the Double-Ring Infiltrometer Test. The actual testing protocols and methods used for a specific project should be determined by a licensed professional engineer with geotechnical expertise.

Table 5.9: Test Pit/Boring Requirements for Infiltration

Facility	Recommended # of Permeability Tests
<ul style="list-style-type: none"> • Infiltration Basin • Subsurface Infiltration • Dry Well • Bioretention Basin • Permeable Pavement 	1 test per 2,500 sq-ft
<ul style="list-style-type: none"> • Infiltration Trench 	1 test per 100 linear ft

5.3.3. Design Infiltration Rates

To account for uncertainties and inaccuracies in testing, a correction (i.e., safety) factor shall be applied to the assumed or measured infiltration rate to produce a design infiltration rate for BMP sizing calculations. The minimum safety factor for infiltration facilities is 2.

5.4. Technology Certification

This manual does not endorse specific proprietary products, although many are described. It is left to each developer to determine which proprietary products may be used, and under what circumstances. When considering a proprietary product, the *Water Quality Rules* require that the developer consider performance data, determined by established protocols. The City accepts certifications of product performance by the Washington State Department of Ecology [Technology Assessment Protocol- Ecology (TAPE)], for the New Jersey's Department of Environmental Protection [New Jersey Corporation for Advanced Technology (NJCAT)].

For proprietary biofiltration systems, the BMP must be certified for general use by TAPE for Enhanced Treatment (for the treatment of dissolved metals), Phosphorous Treatment, or Oil Treatment, according to the predominant pollutant(s) of concern at that site.

For alternative compliance, the device must provide, at minimum, a TSS removal rate of 80%, certified for general use by TAPE or verified by NJCAT consistent with the New Jersey Department of Environmental Protection (NJDEP) protocols.

It can be expected that subsequent to the publishing of this manual, new public-domain technologies will be proposed (or design criteria for existing technologies will be altered) by development engineers. As with proprietary products, it is advised that new public-domain technologies be considered only if performance data are available and have been collected following a widely accepted protocol.

5.5. Feasibility Criteria

Individual BMPs may not be feasible at the site due to site constraints or activities. The City specified feasibility criteria for each BMP in an effort to protect ground water quality, archaeological resources, facilities from inadequate drainage, and avoid compromising the geotechnical/structural integrity of surrounding properties. Infeasibility must be documented using the Feasibility Screening Worksheet (Appendix F of the *Water Quality Rules*).

5.5.1. Infiltration Feasibility

Infiltration BMPs are infeasible and must not be used if any of the following conditions are met:

1. Soils beneath the BMP invert have measured infiltration rates of less than 0.5 in/hr or are USDA HSG “C” or “D” as reported by the USDA Natural Resources Conservation Service.
2. The seasonally high groundwater table is within 3 ft from the BMP invert.
3. There is a documented concern that there is a potential onsite for soil pollutants, ground water pollutants, or pollutants associated with industrial activities to be mobilized.
4. There are geotechnical concerns at the site.
5. Excavation for the installation of the BMP would disturb iwi kupuna or other archeological resources.
6. The BMP cannot be built within the following setbacks:

Distance	From the nearest...
10 ft	private property line
20 ft	building foundation at the project site
35 ft	septic system
50 ft	drinking water well
100 ft	down-gradient building foundation

5.5.2. Harvest/Reuse Feasibility

Harvest/Reuse is considered infeasible for the any of the flowing reasons:

1. The demand is inadequate to reuse the required volume of water.
2. The technical requirements cause the harvesting system to exceed 2% of the total project cost.
3. The site where a cistern must be located is at a slope greater than 10%.
4. There is no available space to locate a cistern of adequate size to harvest and use the required amount of water.
5. The cistern cannot be built within the following setbacks:

Distance	From the nearest...
5 ft	private property line or building foundation
10 ft	septic system

6. The project includes a reclaimed water system and demand for a harvest/reuse system cannot be met.

5.5.3. *Biofiltration Feasibility*

Biofiltration BMPs must be evaluated individually for feasibility as each has different applications. Only if all biofiltration BMPs are infeasible can alternative compliance be used.

1. Vegetated Biofilters are infeasible for any of the following reasons:
 - a. Excavation would disturb iwi kupuna or other archaeological resources.
 - b. The invert of underdrain layer is below seasonally high groundwater table.
 - c. The site does not receive enough sunlight to support vegetation.
 - d. The site lacks sufficient hydraulic head to support BMP operation by gravity.
 - e. Unable to operate off-line with bypass and unable to operate in-line with safe overflow mechanism.
2. Green Roofs are infeasible for any of the following reasons:
 - a. The roof is for a single family residential dwelling.
 - b. Roof space is unavailable due to renewable energy, electrical, and/or mechanical systems.
 - c. Slope on roof exceeds 25% (14 degrees).
3. Dry Swales or Enhanced Swales are infeasible for any of the following reasons:
 - a. Excavation would disturb iwi kupuna or other archaeological resources.
 - b. The invert of underdrain layer is below seasonally high groundwater table.
 - c. The site lacks sufficient head to support BMP operation by gravity.
 - d. Unable to operate off-line with bypass and unable to operate in-line with safe overflow mechanism.
4. Vegetated Swales are infeasible for any of the following reasons:
 - a. The excavation would disturb iwi kupuna or other archaeological resources.
 - b. The site does not receive enough sunlight to support vegetation.
 - c. Unable to operate off-line with bypass and unable to operate in-line with safe overflow mechanism.
5. Vegetated filter strips are infeasible for any of the following reasons:
 - a. Excavation would disturb iwi kupuna or other archaeological resources.
 - b. The site does not receive enough sunlight to support vegetation.
 - c. Unable to operate off-line with bypass and unable to operate in-line with safe overflow mechanism.

This page is intentionally left blank.

6. Considerations for Construction Treatment Control BMPs

As described in Section 1 of this document, the *Water Quality Rules* requires that a licensed engineer inspect BMPs during construction and must certify that they were built according to plan. Precautions must be taken during construction to ensure that permanent BMPs are installed as designed and function as intended.

The first and most important step in protecting permanent BMPs during construction is to utilize phasing to minimize the exposure of these structures to sediment. The following is a typical construction sequence. Depending on the BMP and design variation, alterations may be necessary. Note that Erosion and Sediment Control methods must adhere to the *Water Quality Rules* requirements throughout the duration of construction.

1. Protect future infiltration areas from compaction prior to installation. Clearly mark the existing vegetated areas to be preserved and future infiltration facilities with flags or temporary fencing.
2. Stabilize the entire area draining to the infiltration facility before construction of the infiltration facility begins. Or, construct a diversion berm around the perimeter of the infiltration site to prevent sediment transport during construction.
3. Excavate Structural Infiltration facilities to a uniform, level, uncompacted subgrade, free from rocks and debris. Excavation should be performed with the lightest practical equipment and should be placed outside the limits of the infiltration facility. If the use of heavy equipment on the base of the facility cannot be avoided, the infiltrative capacity must be restored by soil amendments or aerating prior to placing the infiltrative bed.
4. Complete final grading to achieve proposed design elevations, leaving space for upper layer of compost, mulch or topsoil as specified on plans.
5. Plant vegetation according to planting plan. Erosion and sediment control measures, such as temporary seeding and erosion control mats, should be used on vegetated slopes if appropriate.
6. Where pervious pavement is to be installed, installation of the pavement shall be scheduled as the last installation at a development site. Vehicular traffic should be prohibited for at least two (2) days following installation. Site materials should not be stored on pervious pavement.
7. Continue to use erosion and sediment control BMPs such as inlet protection and perimeter control to protect permanent BMPs until they are ready to be brought online. Once the drainage area is completely and permanently stabilized, the system can be brought online.
8. Consider re-verifying permeability prior to acceptance of the BMP.

For proprietary systems, the City recommends to follow manufacturers' installation guidelines while applying the basic principles outlined above.

Guidance on maintenance of BMPs after construction is presented in Section 7.

This page is intentionally left blank.

7. Operations and Maintenance of BMPs

Once built, BMPs require ongoing, long-term inspection and maintenance to ensure that BMPs are meeting the specified design criteria for storm water flow rate, volume and water quality. If the BMPs are not properly maintained the effectiveness of the BMP decreases and may impact water quality. Routine maintenance will also help avoid more costly rehabilitative maintenance to repair damages that may occur when BMPs have not been adequately maintained on a regular basis. For these reasons, the City requires project applicants to develop and record an O&M Plan as part of the permitting process.

7.1. Consideration when Selecting Treatment BMPs

The long-term performance of BMPs hinges on ongoing and proper maintenance. Consideration of the time and funding necessary to support long term maintenance should be included as part of the process when selecting treatment BMP(s). Maintenance costs will also include disposal of accumulated residuals. Residuals include trash, oil and grease, filter media and fine sediments.

7.1.1. *Sediment and Oil Removal and Disposal*

Over time, BMPs will accumulate sediment, which will need to be removed to prevent clogging and reduction in effectiveness. Routine maintenance activities need to include measuring the depth of sediment as part of routine maintenance events and included in the maintenance log. Sediment should be removed when sediment accumulation reaches thirty (30) percent of total capacity. Thirty (30) percent of a facility's capacity is calculated by multiplying the total capacity by 0.30.

Some facilities may require professional assistance, such as underground facilities and manufactured facilities that have confined spaces. These types of facilities require proper certifications to enter or must be cleaned by a vactor truck. Vacuuming with a vactor truck or street sweeping equipment may be required for certain components, such as collection basins, piping or pervious pavement systems.

The owner is responsible for properly disposing accumulated residuals. Current research generally indicates that residuals are not hazardous wastes and can be disposed of residuals the same way any uncontaminated soil would be dispose of, following dewatering. If the BMP treats runoff from areas where chemical or hazardous wastes could come into contact with storm water and an oily sheen, odor, discoloration or other signs of pollution is observed, hire a professional laboratory or sampling firm to assess whether the material needs specialized hauling, treatment, or disposal. If you need assistance deciding whether the solids must be managed as hazardous waste, contact the City Department of Environmental Services - Solid Waste Division.

7.1.2. *Maintenance Costs*

The City requires the applicant to include a description of the funding mechanism for long-term operation and maintenance in the SWQR. For homeowner associations, this could be a portion of homeowner fees or a specific assessment.

Maintenance costs need to include both routine (i.e., inspection, debris removal, or vegetation management) and non-routine (i.e., sediment removal, facility component repair/replace or major replanting) maintenance activities. The annual routine maintenance costs are typically between five (5) to ten (10) percent of the facility's total capital cost. For non-routine maintenance costs (i.e.: sediment removal or vegetative replacement), the owner should set aside a percentage of the non-routine maintenance costs per year based on the needed frequency. For example, if the facility needs sediment removal every five (5) years, twenty (20) percent of the total cost for sediment removal must be put aside each year. An additional three (3) to five (5) percent of the capital costs should also be incorporated into the overall maintenance costs for eventual facility replacement. The life expectancy for most treatment BMPs is between twenty-five (25) to fifty (50) years. The owner is responsible for replacing BMPs at the end of their lifecycle.

7.2. Developing the O&M Plan

Detailed O&M plans are required under the *Water Quality Rules* Section (§) 20-3-53. The O&M Plan is required to identify the specific maintenance activities and frequencies for each type of BMP. In addition, these should include indicators for assessing when “as needed” maintenance activities are required.

An O&M plan should be prepared by the project proponents and submitted to the DFM Storm Water Quality Branch (SWQ) prior to closure of any building, grading, grubbing, trenching, or stockpiling permits for Priority A and B projects.

The *Water Quality Rules* require the following as part of the O&M Plan

- Name, phone number and mailing address for the owner of the property.
- Name and phone number for the individual(s), association, or management company responsible ensuring maintenance is being performed.
- Maintenance activities for each BMP.
- Inspection frequencies for each BMP.
- A post-construction BMP plan showing the location of each BMP with a summary of the maintenance activities and inspection schedule for each BMP.

An O&M Template is available from the CCH and is available on their website. General maintenance activities and frequencies that should be included in the O&M plan are provided in **Appendix C**.

7.3. Maintenance Agreements, Certification, and Modifications

An O&M plan is particularly valuable during ownership transitions; for example, when a developer transitions maintenance to a homeowners association, or when a developer turns over maintenance to a new owner. The BMP maintenance plan is also important when evaluating properties for acquisition, allowing long-term costs associated with BMPs to be factored into the property purchase agreement.

Because of the long-term nature of these BMPs, the City requires that the BMP plan and O&M plan be recorded in the State of Hawaii Land Court or Bureau of Conveyances for privately-owned Real Property. A copy of the recorded O&M plan shall be submitted to the Department and Director of the DFM prior to closing the building and/or grading, grubbing, stockpiling or trenching permit(s).

Another valuable factor for ensuring BMP effectiveness is ensuring the BMP is installed according to plan. The City requires the owner to retain/hire a Licensed Engineer in the State of Hawaii and certified

by the DPP to observe the installation of BMPs during construction and submit a signed Certificate of Completion Form to the City prior to closing the building and/or grading, grubbing, stockpiling or trenching permit(s).

Any modifications to the O&M plan after permit closure must be approved by DFM. Modifications to the O&M plan will not be accepted if it reduces the level of protection from pollutant discharge.

7.4. Inspection Requirements

The owner is responsible for operation and maintenance inspections under the *Water Quality Rules*. The owner is required, at a minimum, to conduct an annual inspection of the installed BMP(s) and retain maintenance and inspection records for at least five (5) years. Furthermore, the owner is required to allow the City access to the BMPs for annual inspections to confirm compliance with the approved O&M plan.

The actual maintenance needs may be more frequently than annually. The need for maintenance depends on the type of BMP, amount and quality of runoff delivered to the structural BMP and any pretreatment facilities for that BMP. Maintenance should be performed on a routine basis and whenever needed, based on maintenance indicators. The optimum maintenance frequency is each time the maintenance threshold for removal of materials (sediment, trash, debris or overgrown vegetation) is met. If this maintenance threshold has been exceeded by the time the structural BMP is inspected, the BMP has been operating at reduced capacity. This would mean it is necessary to inspect and maintain the structural BMP more frequently.

During the first year of normal operation of a structural BMP (i.e., when the project is fully built out and occupied), inspection by the property owner's representative is recommended at least monthly. Inspection during a storm event is also recommended. It is during and after a rain event when one can determine if the components of the BMP are functioning properly. The inspection and maintenance frequency can be adjusted, based on the results of the inspections performed during the first year.

7.5. Minimum Maintenance Requirements

There are many different variations of structural BMPs, and structural BMPs may include multiple components. For the purpose of maintenance, the structural BMPs have been grouped into categories based on common maintenance requirements. The following fact sheets are available in **Appendix C**:

- Bioretention Basin
- Detention Basin
- Green Roof
- Infiltration Trench/Basin
- Manufactured Treatment Device
- Pervious Pavement
- Rainwater Harvesting
- Sand Filter
- Vegetated Biofilter
- Vegetated Swale/Strip

The project civil engineer is responsible for tailoring the maintenance activities and frequency based on the components of the structural BMP, and identifying the applicable maintenance indicators. The factsheets are intended to be general guidance and are meant to help prepare the maintenance plan, more explicit maintenance activities may be necessary to ensure proper operation and maintenance.

8. References

- Alameda Countywide Clean Water Program. www.cleanwaterprogram.org/businesses_home.htm
- Arizona Department of Transportation. 2009. *ADOT Post-Construction Best Management Practices Manual*. http://www.azdot.gov/inside_adot/OES/Water_Quality/Stormwater/Manuals.asp
- ASCE. 1998. *Urban Runoff Quality Management, Manual and Report of Engineering Practice 87*. Reston, Virginia.
- Atlanta Regional Commission. 2001. *Georgia Stormwater Management Manual, Volume 2: Technical Handbook*. <http://www.georgiastormwater.com/>
- California Stormwater Quality Association. 2003. *Stormwater Best Management Practice Handbook, Industrial and Commercial*. <http://www.cabmphandbooks.com/>
- California Stormwater Quality Association. 2003. *Stormwater Best Management Practice Handbook, New Development and Redevelopment*. <http://www.cabmphandbooks.com/>
- City and County of Honolulu. 2012. *Green Infrastructure for Homeowners*. https://www.honolulu.gov/rep/site/dfmswq/library/Green_Infrastructure_for_Homeowners-FINAL.pdf
- City and County of Denver. 2013. *Storm Drainage Design and Technical Criteria*. <https://www.denvergov.org/Portals/711/documents/StormMasterPlan/StormDrainageDesignTechnicalCriteria.pdf>
- City of Boulder, Colorado. Partners for a Clean Environment. www.bouldercolorado.gov/www/pace/government/index.html
- City of Los Angeles, California. *Stormwater Program, Best Management Practices for Businesses and Commercial Industries*. www.lastormwater.org/Siteorg/businesses/bmpbusiness.htm
- County of Maui, Hawaii, Document Center, Department of Water. Water Resource Planning Division. www.co.maui.hi.us/DocumentCenterii.aspx
- County of Orange, California. OC Watersheds Industrial/Commercial Businesses Activities. www.ocwatersheds.com/IndustrialCommercialBusinessesActivities.aspx
- County of Santa Barbara, California. Storm Water Management Program. www.sbprojectcleanwater.org/swmp.html
- County of Suffolk, New York. Stormwater Management Program. www.co.suffolk.ny.us/stormwater/bmps_businesses.html

References

- City of Long Beach Development Services. 2012. *Low Impact Development (LID) Best Management Practices (BMP) Design Manual*. <http://www.lbds.info/civica/filebank/blobload.asp?BlobID=3855>
- City of Portland. 2014. *Stormwater Management Manual*. <http://www.portlandoregon.gov/bes/47952>
- City of San Diego. 2016. *Storm Water Standards*. <https://www.sandiego.gov/stormwater/regulations>
- Clean Water Services. 2009. *Low Impact Development Approaches Handbook*. <http://www.cleanwaterservices.org/Content/Documents/Permit/LIDA%20Handbook.pdf>
- Connecticut Department of Environmental Protection. 2004. *Connecticut Stormwater Quality Manual*. http://ct.gov/dep/cwp/view.asp?a=2721&q=325704&depNav_GID=1654
- County of Los Angeles Department of Public Works. 2014. *Low Impact Development (Standards Manual)*. http://dpw.lacounty.gov/DES/design_manuals/
- County of San Diego Department of Public Works. 2012. *Operation and Maintenance Cost Table for Treatment Control BMPs*. <http://www.sandiegocounty.gov/dpw/watersheds/susmp/susmp.html>
- County of San Diego. 2014. *Low Impact Development Handbook, Stormwater Management Strategies*. http://www.sandiegocounty.gov/content/dam/sdc/dplu/docs/LID_Handbook_2014.pdf
- County of Santa Clara. 2012. *C.3. Stormwater Handbook*. http://www.scvurppp-w2k.com/c3_handbook_2012.shtml
- Ekern, P.C., and Chang, J.H. 1985. *Pan Evaporation: State of Hawaii, 1894-1983*. State of Hawaii, Department of Land and Natural Resources, Division of Water and Land Development.
- Idaho Department of Environmental Quality. 2005. *Catalog of Stormwater Best Management Practices for Idaho Cities and Counties*. http://www.deq.idaho.gov/water/data_reports/storm_water/catalog/
- Iowa State University Institute for Transportation. 2009. *Iowa Stormwater Management Manual*. <http://www.intrans.iastate.edu/pubs/stormwater/index.cfm>
- King County Department of Natural Resources and Parks. 2009. *King County, Washington Surface Water Design Manual*. <http://www.kingcounty.gov/environment/waterandland/stormwater.aspx>
- Maine Coastal Program, State Planning Office. 2007. *LID Guidance Manual for Maine Communities*. <http://www.maine.gov/dep/blwq/docwatershed/materials.htm>
- Maine Department of Environmental Protection. 2006. *Stormwater Management for Maine, Volume III BMPs Technical Design Manual*. <http://www.maine.gov/dep/blwq/docstand/stormwater/stormwaterbmps/index.htm>
- Maryland Department of the Environment. 2000. *Maryland Stormwater Design Manual*. <http://www.mde.state.md.us/programs/Water/StormwaterManagementProgram/MarylandStormwaterDesignManual/>
- New Hampshire Department of Environmental Services. 2008. *New Hampshire Stormwater Manual, Volume 2, Post-Construction Best Management Practices Selection and Design*. <http://des.nh.gov/organization/divisions/water/stormwater/>
-

-
- New Jersey Department of Environmental Protection, Division of Watershed Management. 2009. *New Jersey Stormwater Best Management Practices Manual*. <http://www.state.nj.us/dep/stormwater/>
- North Carolina State University. 2009. *Low Impact Development, A Guidebook for North Carolina*. <http://www.ces.ncsu.edu/depts/agecon/WECO/lidguidebook/>
- National Oceanic Atmospheric Association Coral Reef Conservation Program. 2014. *Storm Water management in Pacific and Caribbean Islands: A practitioner's guide to Implementing LID*. http://data.nodc.noaa.gov/coris/library/NOAA/CRCP/project/1906/Feb2014_IslandBMPGuide_wAppendix.pdf
- Pennsylvania Department of Environmental Protection. 2006. *Pennsylvania Stormwater Best Management Practices Manual*. <http://www.elibrary.dep.state.pa.us/dsweb/View/Collection-8305>
- Prince George's County, Maryland, Department of Environmental Resource. 1999. *Low Impact Development Design Strategies, An Integrated Design Approach*. <http://www.lowimpactdevelopment.org/publications.htm>
- Prince George's County, Maryland, Department of Environmental Resources. 2007. *Bioretention Manual*. <http://www.princegeorgescountymd.gov/der/esg/bioretention/bioretention.asp>
- Rawls, W. J., D. L. Brakensiek and K. E. Saxton. 1982. *Estimation of Soil Water Properties*. Transactions ASAE, 25(5)1316-1320, 1328.
- Riverside County Flood Control and Water Conservation District. 2006. *Riverside County Stormwater Quality Best Management Practice Design Handbook*. [http://www.floodcontrol.co.riverside.ca.us/downloads/Planning/BMP%20Handbook%20\(draft%208\).pdf](http://www.floodcontrol.co.riverside.ca.us/downloads/Planning/BMP%20Handbook%20(draft%208).pdf)
- San Francisco Public Utilities Commission. *Rainwater Harvesting System Sizing Calculator*. http://sfwater.org/msc_main.cfm/MC_ID/17/MSC_ID/404
- Southeast Michigan Council of Governments. 2008. *Low Impact Development Manual for Michigan: A Design Guide for Implementers and Reviewers*. <http://www.semcog.org/lowimpactdevelopment.aspx>
- State of California Department of Transportation. 2010. *Stormwater Quality Handbooks, Project Planning and Design Guide*. <http://www.dot.ca.gov/hq/oppd/stormwtr/>
- State of Hawaii, Department of Health, Wastewater Branch. 2009. *Guidelines for the Reuse of Gray Water*. http://hawaii.gov/wastewater/pdf/graywater_guidelines.pdf
- State of Hawaii Department of Transportation. 2007. *Storm Water Permanent Best Management Practices Manual*. <http://stormwaterhawaii.com/pdfs/PermanentManual.pdf>
- State of Hawaii Office of Planning, Coastal Zone Management Program. 2006. *Hawaii Low Impact Development, A Practitioner's Guide*. <http://hawaii.gov/dbedt/czm/initiative/lid.php>
- State of New York Department of Environmental Conservation. 2010. *New York State Stormwater Management Design Manual*. <http://www.dec.ny.gov/chemical/29072.html>
-

References

- University of California Cooperative Extension, California Department of Water Resources. 2000. *A Guide to Estimating Irrigation Water Needs of Landscape Plantings in California*. <http://www.water.ca.gov/wateruseefficiency/docs/wucols00.pdf>
- University of Hawaii at Manoa, College of Tropical Agriculture and Human Resources. 2010. *Guidelines on Rainwater Catchment Systems for Hawaii*. <http://www.ctahr.hawaii.edu/Site/PubList.aspx?key=Forest%20and%20Natural%20Resource%20Management>
- Urban Drainage and Flood Control District. 2010. *Urban Storm Drainage Criteria Manual, Volume 3 - Best Management Practices*. http://www.udfcd.org/downloads/down_critmanual.htm
- U.S. Department of Agriculture, Natural Resources Conservation Service. 2006. *Soil Data Mart*. <http://soildatamart.nrcs.usda.gov/>
- U.S. Department of Commerce National Oceanic and Atmospheric Administration, National Climatic Data Center. 2002. *Climatography of the United States No. 81, Monthly Normals of Temperature, Precipitation, and Heating and Cooling Degree Days, 1971-2000, Hawaii*. <http://cdo.ncdc.noaa.gov/cgi-bin/climatenormals/climatenormals.pl>
- U.S. Environmental Protection Agency. 2004. *Stormwater Best Management Practice Design Guide, Volume 2, Vegetative Biofilters*. <http://www.epa.gov/ORD/NRMRL/pubs0402.html>
- U.S. Environmental Protection Agency. 2004. *Stormwater Best Management Practice Design Guide, Volume 3, Basin Best Management Practices*. <http://www.epa.gov/ORD/NRMRL/pubs0402.html>
- U.S. Soil Conservation Service. 1986. *Urban Hydrology for Small Watersheds, Technical Release 55*. http://www.wsi.nrcs.usda.gov/products/w2q/H&H/Tools_Models/other/TR55.html
- Ventura Countywide Stormwater Quality Management Program. 2010. *Ventura County Technical Guidance Manual for Stormwater Quality Control Measures*. <http://www.vcstormwater.org/technicalguidancemanual.html>
- Virginia Department of Conservation and Recreation. 2011. *Virginia DCR Stormwater Design Specification No. 3, Grass Channels*. <http://www.vwrrc.vt.edu/swc/NonProprietaryBMPs.html>
- Virginia Department of Conservation and Recreation. 2011. *Virginia DCR Stormwater Design Specification No. 5, Vegetated Roof*. <http://www.vwrrc.vt.edu/swc/NonProprietaryBMPs.html>
- Virginia Department of Conservation and Recreation. 2011. *Virginia DCR Stormwater Design Specification No. 7, Permeable Pavement*. <http://www.vwrrc.vt.edu/swc/NonProprietaryBMPs.html>
- Virginia Department of Conservation and Recreation. 2011. *Virginia DCR Stormwater Design Specification No. 8, Infiltration Practices*. <http://www.vwrrc.vt.edu/swc/NonProprietaryBMPs.html>
- Virginia Department of Conservation and Recreation. 2011. *Virginia DCR Stormwater Design Specification No. 9, Bioretention*. <http://www.vwrrc.vt.edu/swc/NonProprietaryBMPs.html>
- Virginia Department of Conservation and Recreation. 2011. *Virginia DCR Stormwater Design Specification No. 10, Dry Swales*. <http://www.vwrrc.vt.edu/swc/NonProprietaryBMPs.html>
-

-
- Washington State University Extension. 2012. *Low Impact Development Technical Guidance Manual for Puget Sound*. http://www.psp.wa.gov/downloads/LID/20121221_LIDmanual_FINAL_secure.pdf
- Western Regional Climate Center, National Oceanic and Atmospheric Administration. *Average Pan Evaporation Data by State*. <http://www.wrcc.dri.edu/htmlfiles/westevap.final.html>
- Western Regional Climate Center, National Oceanic and Atmospheric Administration. *Comparative Data for the Western States*. <http://www.wrcc.dri.edu/htmlfiles/>

This page is intentionally left blank.

Appendix A: Source Control BMP Fact Sheets

This section describes specific Source Control (SC) BMPs to be considered for incorporation into newly developed public and private infrastructure, as well as retrofit into existing facilities to meet storm water management objectives.

Source Control BMPs are required for all Priority A and B projects for the following activities and areas:

- Landscaped Areas
- Automatic Irrigation Systems
- Storm Drain Inlets
- Vehicle/Equipment Fueling
- Vehicle/Equipment Repair
- Vehicle/Equipment Washing/Cleaning
- Loading Docks
- Outdoor Trash Storage
- Outdoor Material Storage
- Outdoor Work Areas
- Outdoor Process Equipment Operations
- Parking Areas

The following fact sheets are included in this guidance manual and recommended by CCH but are not required by the *Water Quality Rules*.

- Alternative Building Materials
- Roof Runoff Controls

The following information is provided for each of the above-listed BMPs:

- Brief Description/Approach
- Suitable Applications
- Design Considerations
- Design Guidelines
- Examples
- Operations & Maintenance Recommendations

This page is intentionally left blank.

SC-01: Landscaped Areas



Design Objectives	
✓	Maximum Infiltration
✓	Provide On-Site Retention
✓	Slow Runoff
✓	Minimize Impervious Land Coverage
✓	Implement LID
	Prohibit Dumping of Improper Materials
	Contain Pollutants
	Collect and Convey

Description

Each project site possesses unique topographic, hydrologic, and vegetative features, some of which are more suitable for development than others. Integrating and incorporating appropriate landscape planning methodologies into the project design is the most effective action that can be done to minimize surface and groundwater contamination from storm water.

Approach

Landscape planning should couple consideration of land suitability for urban uses with consideration of community goals and projected growth. Project plan designs should conserve natural areas to the maximum extent possible, maximize natural water storage and infiltration opportunities, and protect slopes and channels.

Suitable Applications

Appropriate applications include residential, commercial and industrial areas planned for development or redevelopment.

Design Considerations

Design requirements for site design and landscapes planning should conform to applicable standards and specifications of agencies with jurisdiction and be consistent with applicable General Plan and Local Area Plan policies.

Design Guidelines

- Conserve natural areas to the extent possible.
- Maximize natural water storage and infiltration opportunities to the extent possible.
- Limit runoff from landscaped areas to impervious areas.
- Protect slopes and channels.

Designing New Installations

Begin the development of a plan for the landscape unit with attention to the following general principles:

- Formulate the plan on the basis of clearly articulated community goals. Carefully identify conflicts and choices between retaining and protecting desired resources and community growth.
- Map and assess land suitability for urban uses. Include the following landscape features in the assessment: wooded land, open un-wooded land, steep slopes, erosion-prone soils, foundation suitability, soil suitability for waste disposal, aquifers, aquifer recharge areas, wetlands, floodplains, surface waters, agricultural lands, and various categories of urban land use. When appropriate, the assessment can highlight outstanding local or regional resources that the community determines should be protected (i.e., a scenic area, recreational area, threatened species habitat, farmland, fish run). Mapping and assessment should recognize not only these resources but also additional areas needed for their sustenance.

Project plan designs should conserve natural areas to the extent possible, maximize natural water storage and infiltration opportunities, and protect slopes and channels.

Conserve Natural Areas during Landscape Planning

If applicable, the following items are required and must be implemented in the site layout during the subdivision design and approval process, consistent with applicable General Plan and Local Area Plan policies:

- Cluster development on least-sensitive portions of a site while leaving the remaining land in a natural undisturbed condition.
- Limit clearing and grading of native vegetation at a site to the minimum amount needed to build lots, allow access, and provide fire protection.
- Maximize trees and other vegetation at each site by planting additional vegetation, clustering tree areas, and promoting the use of native and/or drought tolerant plants.
- Promote natural vegetation by using parking lot islands and other landscaped areas.
- Preserve riparian areas and wetlands.

Maximize Natural Water Storage and Infiltration Opportunities within the Landscape Unit

- Promote the conservation of forest cover. Building on land that is already deforested affects basin hydrology to a lesser extent than converting forested land. Loss of forest cover reduces interception storage, detention in the organic forest floor layer, and water losses by evapotranspiration, resulting in large peak runoff increases and either their negative effects or the expense of countering them with structural solutions.
- Maintain natural storage reservoirs and drainage corridors, including depressions, areas of permeable soils, swales, and intermittent streams. Develop and implement policies and regulations to discourage the clearing, filling, and channelization of these features. Utilize them in drainage networks in preference to pipes, culverts, and engineered ditches.
- Evaluating infiltration opportunities by referring to the storm water management manual for the jurisdiction and pay particular attention to the selection criteria for avoiding groundwater contamination, poor soils, and hydro-geological conditions that cause these facilities to fail. If necessary, locate developments with large amounts of impervious surfaces or a potential to produce relatively contaminated runoff away from groundwater recharge areas.

Protection of Slopes and Channels during Landscape Design

- Convey runoff safely from the tops of slopes.
- Avoid disturbing steep or unstable slopes.
- Avoid disturbing natural channels.
- Stabilize disturbed slopes as quickly as possible.
- Vegetated slopes with native or drought tolerant vegetation.
- Control and treat flows in landscaping and/or other controls prior to reaching existing natural drainage systems.
- Stabilize temporary and permanent channel crossings as quickly as possible, and ensure that increases in run-off velocity and frequency caused by the project do not erode the channel.
- Install energy dissipaters, such as riprap, at the outlets of new storm drains, culverts, conduits, or channels that enter unlined channels in accordance with applicable specifications to minimize erosion. Energy dissipaters shall be installed in such a way as to minimize impacts to receiving waters.
- Line on-site conveyance channels where appropriate, to reduce erosion caused by increased flow velocity due to increases in tributary impervious area. The first choice for linings should be grass or some other vegetative surface, since these materials not only reduce runoff velocities, but also provide water quality benefits from filtration and infiltration. If velocities in the channel are high enough to erode grass or other vegetative linings, riprap, concrete, soil cement, or geo-grid stabilization are other alternatives.
- Consider other design principles that are comparable and equally effective.

Redeveloping Existing Installations

The City's SWMPP defines "redevelopment" as development that would create or add impervious surface area on an already developed site. Redevelopment includes, but is not limited to:

- Expansion of a building footprint.
- Addition to or replacement of a structure.
- Replacement of an impervious surface that is not part of a routine maintenance activity.
- Land disturbing activities related to structural or impervious surfaces.

Redevelopment may present significant opportunity to add features which had not previously been implemented. Examples include incorporation of depressions, areas of permeable soils, and swales in newly redeveloped areas. While some site constraints may exist due to the status of already existing infrastructure, opportunities should not be missed to maximize infiltration, slow runoff, reduce impervious areas, and disconnect directly connected impervious areas.

O&M Recommendations

- Do not use pesticides and fertilizers during wet weather or when rain is forecast, and minimize their use during dry weather.
- Do not blow or rake leaves, grass, or garden clippings into the street, gutter, or storm drain.
- Do not apply any chemicals (insecticide, herbicide, or fertilizer) directly to surface waters, unless the application is approved and permitted by the state.

- Dispose of grass clippings, leaves, sticks, or other collected vegetation as garbage, or by composting. Do not dispose of collected vegetation into waterways or storm drainage systems.
- Use mulch or other erosion control measures on exposed soils.
- Check irrigation schedules so pesticides will not be washed away and to minimize non-storm water discharge.

References

California Stormwater Quality Association (CASQA) Best Management Practices Handbook New Development and Redevelopment, 2003.

A Manual for the Standard Urban Stormwater Mitigation Plan (SUSMP), Los Angeles County, Department of Public Works, May 2002.

Stormwater Management Manual for Western Washington, Washington State Department of Ecology, August 2001.

Model Standard Urban Storm Water Mitigation Plan (SUSMP) for San Diego County, Port of San Diego, and Cities in San Diego County, February 14, 2002.

Model Water Quality Management Plan (WQMP) for County of Orange, Orange County Flood Control District, and the Incorporated Cities of Orange County, Draft February 2003.

Ventura Countywide Technical Guidance Manual for Stormwater Quality Control Measures, July 2002.

SC-02: Roof Runoff Controls



Design Objectives	
✓	Maximum Infiltration
✓	Provide On-Site Retention
✓	Slow Runoff
	Minimize Impervious Land Coverage
✓	Implement LID
	Prohibit Dumping of Improper Materials
✓	Contain Pollutants
	Collect and Convey

Description

Various roof runoff controls are available to address storm water that drains off rooftops. The objective is to reduce the total volume and rate of runoff from individual lots, and retain the pollutants on site that may be picked up from roofing materials and atmospheric deposition. Roof runoff controls consist of directing the roof runoff away from paved areas and mitigating flow to the storm drain system through one of several general approaches: cisterns or rain barrels; dry wells or infiltration trenches; green roofs (LID, see TC-07), pop-up emitters, and foundation planting. The first three (3) approaches require the roof runoff to be contained in a gutter and downspout system. Foundation planting provides a vegetated strip under the drip line of the roof.

Approach

Design of individual lots for single-family homes as well as lots for higher density residential and commercial structures should consider site design provisions for containing and infiltrating roof runoff or directing roof runoff to vegetative swales or buffer areas. Retained water can be reused for watering gardens, lawns, and trees. Benefits to the environment include reduced demand for potable water used for irrigation, improved storm water quality, increased groundwater recharge, decreased runoff volume and peak flows, and decreased flooding potential.

Suitable Applications

Appropriate applications include residential, commercial and industrial areas planned for development or redevelopment.

Design Considerations

Designing New Installations

Cisterns or Rain Barrels

One (1) method of addressing roof runoff is to direct roof downspouts to cisterns or rain barrels. A cistern is an above ground storage vessel with either a manually operated valve or a permanently open outlet. Roof runoff is temporarily stored and then released for irrigation or infiltration between storms. The number of rain barrels needed is a function of the rooftop area. Some low impact developers recommend that every house have at least two (2) rain barrels, with a minimum storage capacity of 1,000 liters. Roof barrels serve several purposes including mitigating the first flush from the roof which has a high volume, amount of contaminants, and thermal load. Several types of rain barrels are commercially available. Consideration must be given to selecting rain barrels that are vector proof and childproof. In addition, some barrels are designed with a bypass valve that filters out grit and other contaminants and routes overflow to a soak-away pit or rain garden.

If the cistern has an operable valve, the valve can be closed to store storm water for irrigation or infiltration between storms. This system requires continual monitoring by the resident or grounds crews, but provides greater flexibility in water storage and metering. If a cistern is provided with an operable valve and water is stored inside for long periods, the cistern must be covered to prevent mosquitoes from breeding.

A cistern system with a permanently open outlet can also provide for metering storm water runoff. If the cistern outlet is significantly smaller than the size of the downspout inlet (say $\frac{1}{4}$ to $\frac{1}{2}$ inch diameter), runoff will build up inside the cistern during storms, and will empty out slowly after peak intensities subside. This is a feasible way to mitigate the peak flow increases caused by rooftop impervious land coverage, especially for the frequent, small storms.

Dry Wells and Infiltration Trenches

Roof downspouts can be directed to dry wells or infiltration trenches. A dry well is constructed by excavating a hole in the ground and filling it with an open graded aggregate, and allowing the water to fill the dry well and infiltrate after the storm event. An underground connection from the downspout conveys water into the dry well, allowing it to be stored in the voids. To minimize sedimentation from lateral soil movement, the sides and top of the stone storage matrix can be wrapped in a permeable filter fabric, though the bottom may remain open. A perforated observation pipe can be inserted vertically into the dry well to allow for inspection and maintenance.

In practice, dry wells receiving runoff from single roof downspouts have been successful over long periods because they contain very little sediment. They should be sized according to the amount of rooftop runoff received, but are typically 4 to 5 sq-ft, and 2 to 3 ft deep, with a minimum of 1-ft soil cover over the top (maximum depth of 10 ft).

To protect the foundation, dry wells must be set away from the building at least 10 ft. The location of drywells should be determined by a licensed engineer. They must be installed in solids that accommodate infiltration. In poorly drained soils, dry wells have very limited feasibility. Overflow shall be directed away from the structure and surrounding buildings.

Infiltration trenches function in a similar manner and would be particularly effective for larger roof areas. An infiltration trench is a long, narrow, rock-filled trench with no outlet that receives storm water runoff. These are described under Treatment Controls.

Pop-up Drainage Emitter

Roof downspouts can be directed to an underground pipe that daylights some distance from the building foundation, releasing the roof runoff through a pop-up emitter. Similar to a pop-up irrigation head, the emitter only opens when there is flow from the roof. The emitter remains flush to the ground during dry periods, for ease of lawn or landscape maintenance.

Foundation Planting

Landscape planting can be provided around the base to allow increased opportunities for storm water infiltration and protect the soil from erosion caused by concentrated sheet flow coming off the roof. Foundation plantings can reduce the physical impact of water on the soil and provide a subsurface matrix of roots that encourage infiltration. These plantings must be sturdy enough to tolerate the heavy runoff sheet flows, and periodic soil saturation.

Redeveloping Existing Installations

The City's SWMPP defines "redevelopment" as development that would create or add impervious surface area on an already developed site. The definition of "redevelopment" must be consulted to determine whether or not the requirements for new development apply to areas intended for redevelopment. If the definition applies, the steps outlined under "designing new installations" above should be followed.

Supplemental Information

Examples

- City of Ottawa's Water Links Surface –Water Quality Protection Program
- City of Toronto Downspout Disconnection Program
- City of Boston, MA, Rain Barrel Demonstration Program

References

California Stormwater Quality Association (CASQA) Best Management Practices Handbook New Development and Redevelopment, 2003.

Hager, Marty Catherine, Stormwater, "Low-Impact Development," January/February 2003. <http://www.stormh2o.com/SW/Articles/226.aspx>

Low Impact Urban Design Tools, Low Impact Development Design Center, Beltsville, MD. www.lid-stormwater.net.

Start at the Source, Bay Area Stormwater Management Agencies Association, 1999 Edition.

This page is intentionally left blank.

SC-03: Automatic Irrigation System



Design Objectives	
✓	Maximum Infiltration
✓	Provide On-Site Retention
✓	Slow Runoff
	Minimize Impervious Land Coverage
✓	Implement LID
	Prohibit Dumping of Improper Materials
✓	Contain Pollutants
	Collect and Convey

Description

Irrigation water provided to landscaped areas may result in excess irrigation water being conveyed into storm water drainage systems.

Approach

Project plan designs for development and redevelopment should include application methods of irrigation water that minimize runoff of excess irrigation water into the storm water conveyance system.

Suitable Applications

Appropriate applications include residential, commercial and industrial areas planned for development or redevelopment. Detached residential single-family homes are typically excluded from this requirement.

Design Considerations

Design Guidelines

- Design irrigation systems to each landscape area's specific water requirements.
- Implement landscape plans consistent with City water conservation resolutions, which may include provision of drip irrigation, water sensors, programmable irrigation times (for short cycles), etc.
- Design timing and application methods of irrigation water to minimize the runoff of excess irrigation water into the storm water drainage system.
- Group plants with similar water requirements in order to reduce excess irrigation runoff and promote surface filtration.

Designing New Installations

The following methods to reduce excessive irrigation runoff should be considered, and incorporated and implemented where determined applicable and feasible:

- Employ rain-triggered shutoff devices to prevent irrigation after precipitation.
- Design irrigation systems to each landscape area's specific water requirements.
- Include design featuring flow reducers or shutoff valves triggered by a pressure drop to control water loss in the event of broken sprinkler heads or lines.
- Implement landscape plans consistent with City water conservation resolutions, which may include provision of water sensors, programmable irrigation times (for short cycles), etc.
- Design timing and application methods of irrigation water to minimize the runoff of excess irrigation water into the storm water drainage system.
- Group plants with similar water requirements in order to reduce excess irrigation runoff and promote surface filtration. Choose plants with low irrigation requirements (for example, native or drought tolerant species). Consider design features such as:
 - Using mulches (such as wood chips or bar) in planter areas without ground cover to minimize sediment in runoff.
 - Installing appropriate plant materials for the location, in accordance with amount of sunlight and climate, and use native plant materials where possible and/or as recommended by the landscape architect.
 - Leaving a vegetative barrier along the property boundary and interior watercourses, to act as a pollutant filter, where appropriate and feasible.
 - Choosing plants that minimize or eliminate the use of fertilizer or pesticides to sustain growth.
- Employ other comparable, equally effective methods to reduce irrigation water runoff.

Redeveloping Existing Installations

The City's SWMPP defines "redevelopment" as development that would create or add impervious surface area on an already developed site. The definition of "redevelopment" must be consulted to determine whether or not the requirements for new development apply to areas intended for redevelopment. If the definition applies, the steps outlined under "designing new installations" above should be followed.

O&M Recommendations

- Inspect irrigation system periodically to ensure that the right amount of water is being applied and that excessive runoff is not occurring.
- Minimize excess watering, and repair leaks in the irrigation system as soon as they are observed.

References

California Stormwater Quality Association (CASQA) Best Management Practices Handbook New Development and Redevelopment, 2003.

A Manual for the Standard Urban Stormwater Mitigation Plan (SUSMP), Los Angeles County Department of Public Works, May 2002.

Model Standard Urban Storm Water Mitigation Plan (SUSMP) for San Diego County, Port of San Diego, and Cities in San Diego County, February 14, 2002.

Model Water Quality Management Plan (WQMP) for County of Orange, Orange County Flood Control District, and the Incorporated Cities of Orange County, Draft February 2003.

Ventura Countywide Technical Guidance Manual for Stormwater Quality Control Measures, July 2002.

This page is intentionally left blank.

SC-04: Storm Drain Inlet



Design Objectives	
	Maximum Infiltration
	Provide On-Site Retention
	Slow Runoff
	Minimize Impervious Land Coverage
	Implement LID
✓	Prohibit Dumping of Improper Materials
	Contain Pollutants
	Collect and Convey

Description

Waste materials dumped into storm drain inlets can have severe impacts on receiving and ground waters. Posting notices regarding discharge prohibitions at storm drain inlets can prevent waste dumping. Storm drain signs and stencils are highly visible source controls that are placed directly adjacent to storm drain inlets.

Approach

The stencil or affixed sign contains a brief statement that prohibits dumping of improper materials into the urban runoff conveyance system. Stencils and signs alert the public to the destination of pollutants discharged to the storm drain.

Suitable Applications

Stencils and signs alert the public to the destination of pollutants discharged to the storm drain. Signs are appropriate in residential, commercial, and industrial areas, as well as any other area where contributions or dumping to storm drains is likely.

Design Considerations

Storm drain message markers or placards are recommended at all storm drain inlets within the boundary of a development project. The marker should be placed in clear sight facing toward anyone approaching the inlet from either side. All storm drain inlet locations should be identified on the development site map.

Design Guidelines

- Provide stenciling or labeling of all storm drain inlets and catch basins, constructed or modified, within the project area with prohibitive language.
- Place the marker in clear sight facing toward anyone approaching the inlet from either side.

- Be aware that signage on face of curbs tends to be worn by contact with vehicle tires and sweeper brooms.
- Post signs with prohibitive language and/or graphical icons, which prohibit illegal dumping at public access points along channels and creeks within the project area.

Designing New Installations

The following methods should be considered for inclusion in the project design and shown on project plans:

- Provide stenciling or labeling of all storm drain inlets and catch basins, constructed or modified, within the project area with prohibitive language. Examples include “Dump No Waste” and/or other graphical icons to discourage illegal dumping.
- Post signs with prohibitive language and/or graphical icons, which prohibit illegal dumping at public access points along channels and creeks within the project area.

Note: DFM-SWQ has approved specific signage and/or storm drain message placards for use. Consult local agency storm water staff to determine specific requirements for placard types and methods of application.

Redeveloping Existing Installations

The City’s SWMPP defines “redevelopment” as development that would create or add impervious surface area on an already developed site. If the project meets the definition of “redevelopment,” then the requirements stated under “designing new installations” above should be included in all project design plans.

Supplemental Information

Maintenance Considerations

Legibility of markers and signs should be maintained. If required by the agency with jurisdiction over the project, the owner/operator or homeowner’s association should enter into a maintenance agreement with the agency or record a deed restriction upon the property title to maintain the legibility of placards or signs.

Placement

- Signage on top of curbs tends to weather and fade.
- Signage on face of curbs tends to be worn by contact with vehicle tires and sweeper brooms.

O&M Recommendations

- Inspect signage regularly and maintain as appropriate to ensure legibility.
- Inspect regularly, at least annually, for structural deterioration or significant build-up of debris or sediment.

References

California Stormwater Quality Association (CASQA) Best Management Practices Handbook New Development and Redevelopment, 2003.

A Manual for the Standard Urban Stormwater Mitigation Plan (SUSMP), Los Angeles County Department of Public Works, May 2002.

Model Standard Urban Storm Water Mitigation Plan (SUSMP) for San Diego County, Port of San Diego, and Cities in San Diego County, February 14, 2002.

Model Water Quality Management Plan (WQMP) for County of Orange, Orange County Flood Control District, and the Incorporated Cities of Orange County, Draft February 2003.

Ventura Countywide Technical Guidance Manual for Stormwater Quality Control Measures, July 2002.

This page is intentionally left blank.

SC-05: Alternative Building Materials



Design Objectives	
✓	Maximum Infiltration
✓	Provide On-Site Retention
✓	Slow Runoff
	Minimize Impervious Land Coverage
✓	Implement LID
	Prohibit Dumping of Improper Materials
	Contain Pollutants
	Collect and Convey

Description

Alternative building materials are selected instead of conventional materials for new construction and renovation. These materials reduce potential sources of pollutants in storm water runoff by eliminating compounds that can leach into runoff, reducing the need for pesticide application, reducing the need for painting and other maintenance, or by reducing the volume of runoff.

Approach

Alternative building materials are available for use as lumber for decking, roofing materials, home siding, and paving for driveways, decks, and sidewalks.

Suitable Applications

Appropriate applications include residential, commercial and industrial areas planned for development or redevelopment.

Design Considerations

Design New Installations

Decking

One of the most common materials for construction of decks and other outdoor construction has traditionally been pressure treated wood, which is now being phased out. The standard treatment is called CCA, for chromated copper arsenate. The key ingredients are arsenic (which kills termites, carpenter ants and other insects), copper (which kills the fungi that cause wood to rot) and chromium (which reacts with the other ingredients to bind them to the wood). The amount of arsenic is far from trivial. A deck just 8 ft by 10 ft contains more than 1 1/3 pounds of this highly potent poison. Replacement materials include a new type of pressure treated wood, plastic and composite lumber.

There are currently over 20 products in the market consisting of plastic or plastic-wood composites. Plastic lumber is made from 100% recycled plastic, # 2 high-density polyethylene (HDPE), and polyethylene plastic milk jugs and soap bottles. Plastic-wood composites are a combination of plastic and wood fibers or sawdust. These materials are a long lasting exterior weather, insect, and chemical resistant wood lumber replacement for non-structural applications. Use it for decks, docks, raised garden beds and planter boxes, pallets, hand railings, outdoor furniture, animal pens, boat decks, etc.

New pressure treated wood uses a much safer recipe, ACQ, which stands for ammoniacal copper quartenary. It contains no arsenic and no chromium. Yet the American Wood Preservers Association has found it to be just as effective as the standard formula. ACQ is common in Japan and Europe.

Roofing

Several studies have indicated that metal used as roofing material, flashing, or gutters can leach metals into the environment. The leaching occurs because rainfall is slightly acidic and slowly dissolved the exposed metals. Common traditional applications include copper sheathing and galvanized (zinc) gutters.

Coated metal products are available for both roofing and gutter applications. These products eliminate contact of bare metal with rainfall, eliminating one source of metals in runoff. There are also roofing materials made of recycled rubber and plastic that resemble traditional materials.

A less traditional approach is the use of green roofs (See TC-07). These roofs are not just green, they're alive. Planted with grasses and succulents, low- profile green roofs reduce the urban heat island effect, storm water runoff, and cooling costs, while providing wildlife habitat and a connection to nature for building occupants. These roofs are widely used on industrial facilities in Europe and have been established as experimental installations in several locations in the US, including Portland, Oregon.

Paved Areas

Traditionally, concrete is used for construction of patios, sidewalks, and driveways. Although it is non-toxic, these paved areas reduce storm water infiltration and increase the volume and rate of runoff. This increase in the amount of runoff is the leading cause of stream channel degradation in urban areas.

There are a number of alternative materials that can be used in these applications, including porous concrete and asphalt, modular blocks, and crushed granite. These materials, especially modular paving blocks, are widely available and well established methods to reduce storm water runoff.

Building Siding

Wood siding is commonly used on the exterior of residential construction. This material weathers fairly rapidly and requires repeated painting to prevent rotting. Alternative "new" products for this application include cement-fiber and vinyl. Cement-fiber siding is a masonry product made from Portland cement, sand, and cellulose and will not burn, cup, swell, or shrink.

Pesticide Reduction

A common use of powerful pesticides is for the control of termites. Chlordane was used for many years for this purpose and is now found in urban streams and lakes nationwide. There are a number of physical barriers that can be installed during construction to help reduce the use of pesticides.

Sand barriers for subterranean termites are a physical deterrent because the termites cannot tunnel through it. Sand barriers can be applied in crawl spaces under pier and beam foundations, under slab foundations, and between the foundation and concrete porches, terraces, patios and steps. Other possible locations include under fence posts, underground electrical cables, water and gas lines, telephone and electrical poles, inside hollow tile cells and against retaining walls.

Metal termite shields are physical barriers to termites which prevent them from building invisible tunnels. In reality, metal shields function as a helpful termite detection device, forcing them to build tunnels on the outside of the shields which are easily seen. Metal termite shields also help prevent dampness from wicking to adjoining wood members which can result in rot, thus making the material more attractive to termites and other pests. Metal flashing and metal plates can also be used as a barrier between piers and beams of structures such as decks, which are particularly vulnerable to termite attack.

Redeveloping Existing Installations

The City's SWMPP defines "redevelopment" as development that would create or add impervious surface area on an already developed site. The definition of "redevelopment" must be consulted to determine whether or not the requirements for new development apply to areas intended for redevelopment. If the definition applies, the steps outlined under "designing new installations" above should be followed.

Other Resources

There are no good, independent, comprehensive sources of information on alternative building materials for use in minimizing the impacts of storm water runoff. Most websites or other references to "green" or "alternative" building materials focus on indoor applications, such as formaldehyde free plywood and low VOC paints, carpets, and pads. Some supplemental information on alternative materials is available from the manufacturers.

References

California Stormwater Quality Association (CASQA) Best Management Practices Handbook New Development and Redevelopment, 2003.

This page is intentionally left blank.

SC-06: Vehicle/Equipment Fueling



Design Objectives	
	Maximum Infiltration
	Provide On-Site Retention
	Slow Runoff
	Minimize Impervious Land Coverage
	Implement LID
	Prohibit Dumping of Improper Materials
✓	Contain Pollutants
✓	Collect and Convey

Description

Fueling areas have the potential to discharge oil and grease, solvents, car battery acid, coolant and gasoline to the storm drain. Spills can be a significant source of pollution because fuels contain toxic materials and heavy metals that are not easily removed by storm water treatment devices.

Approach

Project plans must be developed for cleaning near fuel dispensers, emergency spill cleanup, containment, and leak prevention.

Suitable Applications

Appropriate applications include commercial, industrial, and any other areas planned to have fuel dispensing equipment, including retail gasoline outlets, automotive repair shops, and major non-retail dispensing areas.

Design Considerations

Design requirements for fueling areas are governed by Building and Fire Codes and by current local agency ordinances and zoning requirements. Design requirements described in this fact sheet are meant to enhance and be consistent with these code and ordinance requirements.

Design Guidelines

- Covering.** Include an overhanging roof structure or canopy over fuel dispensing areas. The cover's minimum dimensions must be equal to or greater than the area within the grade break. The cover must not drain onto the fuel dispensing area and the downspouts must be routed to prevent drainage across the fueling area. If fueling large equipment or vehicles that prohibit the use of covers or roofs, the fueling island should be designed to accommodate the larger vehicles and equipment and to prevent storm water run-on and runoff.

- **Surfacing.** Pave fuel dispensing areas with Portland cement concrete (or equivalent smooth impervious surface). Extend the paved area a minimum of 6.5 ft from the corner of each fuel dispenser, or the length at which the hose and nozzle assembly may be operated plus 1 ft, whichever is less. The use of asphalt concrete is prohibited. Use asphalt sealant to protect asphalt paved areas surrounding the fueling area.
- **Grading/Contouring.** Slope the dispensing areas to prevent ponding, and separate it from the rest of the site by a grade break that prevents run-on. Grade the fueling areas to drain toward a dead-end sump or vegetated/landscaped area. Direct runoff from downspouts/roofs away from fueling areas towards vegetated/landscaped areas if possible.
- **Drains.** Label all drains within facility boundaries using paint or stencil, to indicate whether flow is to the storm drain, sewer, or oil/water separator.

Designing New Installations

Covering

Fuel dispensing areas should provide an overhanging roof structure or canopy. The cover's minimum dimensions must be equal to or greater than the area within the grade break. The cover must not drain onto the fuel dispensing area and the downspouts must be routed to prevent drainage across the fueling area. The fueling area should drain to the project's treatment control BMP(s) prior to discharging to the storm water conveyance system. Note: If fueling large equipment or vehicles that would prohibit the use of covers or roofs, the fueling island should be designed to sufficiently accommodate the larger vehicles and equipment and to prevent storm water run-on and runoff. Grade to direct storm water to a dead-end sump.

Surfacing

Fuel dispensing areas should be paved with Portland cement concrete (or equivalent smooth impervious surface). The use of asphalt concrete should be minimized. Use asphalt sealant to protect asphalt paved areas surrounding the fueling area. This provision may be made to sites that have pre-existing asphalt surfaces.

The concrete fuel dispensing area should be extended a minimum of 6.5 ft from the corner of each fuel dispenser, or the length at which the hose and nozzle assembly may be operated plus 1 ft, whichever is less.

Grading/Contouring

Dispensing areas should have an appropriate slope to prevent ponding, and be separated from the rest of the site by a grade break that prevents run-on of urban runoff (slope is required to be 2 to 4% in some jurisdictions' storm water management and mitigation plans).

Fueling areas should be graded to drain toward a dead-end sump. Runoff from downspouts/roofs should be directed away from fueling areas. Do not locate storm drains in the immediate vicinity of the fueling area.

Redeveloping Existing Installations

The City's SWMPP defines "redevelopment" as development that would create or add impervious surface area on an already developed site. The definition of "redevelopment" must be consulted to determine

whether or not the requirements for new development apply to areas intended for redevelopment. If the definition applies, the steps outlined under “designing new installations” above should be followed.

Supplemental Information

In the case of an emergency, provide storm drain seals, such as isolation valves, drain plugs, or drain covers, to prevent spills or contaminated storm water from entering the storm water conveyance system.

O&M Recommendations

- Maintain clean fuel-dispensing areas using dry cleanup methods such as sweeping, or use of rags and absorbents for leaks and spills.
- If you clean by washing, place a temporary plug in the downstream drain and pump out the accumulated water. Properly dispose the water.
- Install vapor recovery nozzles to help control drips as well as air pollution.
- Use secondary containment when transferring fuel from the tank truck to the fuel tank. Cover storm drains in the vicinity during transfer.
- Post signs at the fuel dispenser or fuel island warning vehicle owners/operators against "topping off" of vehicle fuel tanks.
- Develop and implement a Spill Prevention Control and Countermeasure (SPCC) Plan.

References

California Stormwater Quality Association (CASQA) Best Management Practices Handbook New Development and Redevelopment, 2003.

A Manual for the Standard Urban Stormwater Mitigation Plan (SUSMP), Los Angeles County Department of Public Works, May 2002.

Model Standard Urban Storm Water Mitigation Plan (SUSMP) for San Diego County, Port of San Diego, and Cities in San Diego County, February 14, 2002.

Model Water Quality Management Plan (WQMP) for County of Orange, Orange County Flood Control District, and the Incorporated Cities of Orange County, Draft February 2003.

Ventura Countywide Technical Guidance Manual for Stormwater Quality Control Measures, July 2002.

This page is intentionally left blank.

SC-07: Vehicle/Equipment Repair



Design Objectives	
	Maximum Infiltration
	Provide On-Site Retention
	Slow Runoff
	Minimize Impervious Land Coverage
	Implement LID
	Prohibit Dumping of Improper Materials
✓	Contain Pollutants
✓	Collect and Convey

Description/Approach

Several measures can be taken to prevent operations at maintenance bays from contributing a variety of toxic compounds, oil and grease, heavy metals, nutrients, suspended solids, and other pollutants to the storm water conveyance system. In designs for maintenance bays containment is encouraged. Preventive measures include overflow containment structures and dead-end sumps.

Design Guidelines

Design requirements for vehicle maintenance and repair are governed by Building and Fire Codes, and by current local agency ordinances, and zoning requirements. The design requirements described hereon are meant to enhance and be consistent with these code requirements.

- Locate repair/maintenance bays indoors; or design them to preclude run-on and runoff.
- Pave repair/maintenance floor areas with Portland cement concrete (or equivalent smooth impervious surface).
- Provide impermeable berms, drop inlets, trench catch basins, or overflow containment structures around repair bays to prevent spilled materials and wash-down waters from entering the storm drain system. Connect drains to a sump for collection and disposal. Direct connection of the repair/maintenance bays to the storm drain system is prohibited.
- Label all drains within facility boundaries using paint or stencil, to indicate whether flow is to the storm drain, sewer, or oil/water separator.

O&M Recommendations

- Avoid hosing down work areas. If work areas are washed, collect and direct wash water to sanitary sewer.
- Do not pour liquid waste down floor drains, sinks, outdoor storm drain inlets, or other storm drains or sewer connections.

- Do not dispose of used or leftover cleaning solutions, solvents, and automotive fluids and oil in the sanitary sewer.
- Keep drip pans or containers under vehicles or equipment that may drip during repairs.
- When steam cleaning or pressure washing parts, the wastewater must be discharged to an on-site oil water separator that is connected to a sanitary sewer or blind sump.
- Develop and implement a Spill Prevention Control and Countermeasure (SPCC) Plan.

SC-08: Vehicle/Equipment Cleaning



Design Objectives	
	Maximum Infiltration
	Provide On-Site Retention
	Slow Runoff
	Minimize Impervious Land Coverage
	Implement LID
	Prohibit Dumping of Improper Materials
✓	Contain Pollutants
✓	Collect and Convey

Description

Vehicle washing, equipment washing, and steam cleaning may contribute high concentrations of pollutants to wash waters that drain to storm water conveyance systems. Wash water may not be conveyed to a sewer without a sewer connection permit.

Approach

Project plans should include appropriately designed area(s) for washing-steam cleaning of vehicles and equipment. Depending on the size and other parameters of the wastewater facility, wash water may be conveyed to a sewer, an infiltration system, recycling system or other alternative. Pretreatment may be required for conveyance to a sanitary sewer.

Suitable Applications

Appropriate applications include commercial developments, restaurants, retail gasoline outlets, automotive repair shops, condominiums, apartment buildings, and others.

Design Considerations

Design requirements for vehicle maintenance are governed by Building and Fire Codes, and by current local agency ordinances, and zoning requirements. Design criteria described in this fact sheet are meant to enhance and be consistent with these code requirements.

Design Guidelines

Commercial Applications

Incorporate at least one of the following features for equipment washing/steam cleaning:

- Be self-contained and/or covered with a roof or overhang.
- Be equipped with a clarifier or other pretreatment facility.

- Have a proper connection to a sanitary sewer.
- Install sumps or drain lines to collect wash water. Divert wash water to the sanitary sewer, an engineered infiltration system, or an equally effective alternative.
- Direct and divert surface water runoff away from the exposed area around the wash pad, and wash pad itself to alternatives other than the sanitary sewer.
- Cover areas used for regular washing of vehicles, trucks, or equipment, surround them with a perimeter berm, and clearly mark them as a designated washing area.
- Label all drains within facility boundaries using paint or stencil, to indicate whether flow is to the storm drain, sewer, or oil/water separator.

Residential Applications

- Designate a car wash area and post signs for area.
- Divert wash water to a vegetated area where it may percolate into the ground, the sanitary sewer, an engineered Infiltration system, or an equally effective alternative.
- Direct and divert surface water runoff away from the wash area to alternatives other than the sanitary sewer.
- Approval for a sanitary connection must be obtained from the City Department of Environmental Services.

Designing New Installations

Areas for washing/steam cleaning should incorporate one of the following features:

- Be self-contained and/or covered with a roof or overhang.
- Be equipped with a clarifier or other pretreatment facility.
- Have a proper connection to a sanitary sewer.
- Include other features which are comparable and equally effective.

Car Wash Areas

Wash water from the areas may be directed to the sanitary sewer, to an engineered infiltration system, or to an equally effective alternative. Pre-treatment may also be required. For residential applications, it can be appropriate to direct wash water to a planted area and allow it to percolate into the ground.

Developers are to direct and divert surface water runoff away from the exposed area around the wash pad (parking lot, storage areas), and wash pad itself to alternatives other than the sanitary sewer. Roofing may be required for exposed wash pads.

It is generally advisable to cover areas used for regular washing of vehicles, trucks, or equipment, surround them with a perimeter berm, and clearly mark them as a designated washing area. Sumps or drain lines can be installed to collect wash water, which may be treated for reuse or recycling, or for discharge to the sanitary sewer. Some areas may require some form of pretreatment, such as a trap, for these areas.

Redeveloping Existing Installations

The City's SWMPP defines "redevelopment" as development that would create or add impervious surface area on an already developed site. The definition of "redevelopment" must be consulted to determine

whether or not the requirements for new development apply to areas intended for redevelopment. If the definition applies, the steps outlined under “designing new installations” above should be followed.

Supplemental Information

Maintenance Considerations

Storm water and non-storm water will accumulate in containment areas and sumps with impervious surfaces. Contaminated accumulated water must be disposed of in accordance with applicable laws and cannot be discharged directly to the storm drain or sanitary sewer system without the appropriate permit.

O&M Recommendations

- Mark the area clearly as a wash area.
- Post signs to state that washing is only allowed in wash area.
- Provide trash container with lids in wash area.
- Recycle, collect or treat wash water effluent prior to discharge to the sanitary sewer system.
- Do not conduct oil changes and other engine maintenance in the designated washing area. Perform these activities in a place designated for oil change and maintenance activities.
- Cover the wash area when not in use to prevent contact with rain water.
- Do not permit steam cleaning wash water to enter the storm drain.
- Develop and implement a Spill Prevention Control and Countermeasure (SPCC) Plan.

References

California Stormwater Quality Association (CASQA) Best Management Practices Handbook New Development and Redevelopment, 2003.

A Manual for the Standard Urban Stormwater Mitigation Plan (SUSMP), Los Angeles County Department of Public Works, May 2002.

Model Standard Urban Storm Water Mitigation Plan (SUSMP) for San Diego County, Port of San Diego, and Cities in San Diego County, February 14, 2002.

Model Water Quality Management Plan (WQMP) for County of Orange, Orange County Flood Control District, and the Incorporated Cities of Orange County, Draft February 2003.

Ventura Countywide Technical Guidance Manual for Storm Water Quality Control Measures, July 2002.

This page is intentionally left blank.

SC-09: Loading Dock



Design Objectives	
	Maximum Infiltration
	Provide On-Site Retention
	Slow Runoff
	Minimize Impervious Land Coverage
	Implement LID
✓	Prohibit Dumping of Improper Materials
✓	Contain Pollutants
	Collect and Convey

Description

Several measures can be taken to prevent operations at loading docks from contributing a variety of toxic compounds, oil and grease, heavy metals, nutrients, suspended solids, and other pollutants to the storm water conveyance system.

Approach

In designs for loading docks, containment is encouraged. Preventive measures include overflow containment structures and dead-end sumps. However, in the case of loading docks from grocery stores and warehouse/distribution centers, engineered infiltration systems may be considered.

Suitable Applications

Appropriate applications include commercial and industrial areas planned for development or redevelopment.

Design Considerations

Design requirements for vehicle maintenance and repair are governed by Building and Fire Codes, and by current local agency ordinances, and zoning requirements. The design criteria described in this fact sheet are meant to enhance and be consistent with these code requirements.

Design Guidelines

Design requirements for vehicle maintenance and repair are governed by Building and Fire Codes, and by current local agency ordinances, and zoning requirements. The design requirements described hereon are meant to enhance and be consistent with these code requirements.

- Cover all loading dock areas, or design them to preclude run-on and runoff.
- Do not allow runoff from depressed loading docks (truck wells) to discharge into storm drains.

- Drain below-grade loading docks from grocery stores and warehouse/distribution centers of fresh food items through water quality inlets, an engineered infiltration system, or an equally effective alternative.
- Grade and/or berm the loading/unloading area to a drain that is connected to a dead-end.
- Pave loading areas with concrete instead of asphalt.

Designing New Installations

Designs of maintenance bays should consider the following:

- Repair/maintenance bays and vehicle parts with fluids should be indoors; or designed to preclude urban run-on and runoff.
- Repair/maintenance floor areas should be paved with Portland cement concrete (or equivalent smooth impervious surface).
- Repair/maintenance bays should be designed to capture all wash water leaks and spills. Provide impermeable berms, drop inlets, trench catch basins, or overflow containment structures around repair bays to prevent spilled materials and wash-down waters from entering the storm drain system. Connect drains to a sump for collection and disposal. Direct connection of the repair/maintenance bays to the storm drain system is prohibited. If required by local jurisdiction, obtain an Industrial Waste Discharge Permit.
- Other features may be comparable and equally effective.

The following designs of loading/unloading dock areas should be considered:

- Loading dock areas should be covered, or drainage should be designed to preclude urban run-on and runoff.
- Direct connections into storm drains from depressed loading docks (truck wells) are prohibited.
- Below-grade loading docks from grocery stores and warehouse/distribution centers of fresh food items should drain through water quality inlets, or to an engineered infiltration system, or an equally effective alternative. Pre-treatment may also be required.
- Other features may be comparable and equally effective.

Redeveloping Existing Installations

The City's SWMPP defines "redevelopment" as development that would create or add impervious surface area on an already developed site. The definition of "redevelopment" must be consulted to determine whether or not the requirements for new development apply to areas intended for redevelopment. If the definition applies, the steps outlined under "designing new installations" above should be followed.

Supplemental Information

Storm water and non-storm water will accumulate in containment areas and sumps with impervious surfaces. Contaminated accumulated water must be disposed of in accordance with applicable laws and cannot be discharged directly to the storm drain or sanitary sewer system without the appropriate permit.

O&M Recommendations

- Develop an operations plan that describes procedures for loading and/or unloading.
- Conduct loading and unloading in dry weather if possible.

- Load and unload all materials and equipment in covered areas if feasible.
- Load/unload only at designated loading areas.
- Check loading and unloading equipment regularly for leaks.
- Look for dust or fumes during loading or unloading operations.
- Develop and implement a Spill Prevention Control and Countermeasure (SPCC) Plan.

References

California Stormwater Quality Association (CASQA) Best Management Practices Handbook New Development and Redevelopment, 2003.

A Manual for the Standard Urban Stormwater Mitigation Plan (SUSMP), Los Angeles County Department of Public Works, May 2002.

Model Standard Urban Storm Water Mitigation Plan (SUSMP) for San Diego County, Port of San Diego, and Cities in San Diego County, February 14, 2002.

Model Water Quality Management Plan (WQMP) for County of Orange, Orange County Flood Control District, and the Incorporated Cities of Orange County, Draft February 2003.

Ventura Countywide Technical Guidance Manual for Stormwater Quality Control Measures, July 2002.

This page is intentionally left blank.

SC-10: Outdoor Trash Storage



Design Objectives	
	Maximum Infiltration
	Provide On-Site Retention
	Slow Runoff
	Minimize Impervious Land Coverage
	Implement LID
	Prohibit Dumping of Improper Materials
✓	Contain Pollutants
	Collect and Convey

Description

Storm water runoff from areas where trash is stored or disposed of can be polluted. In addition, loose trash and debris can be easily transported by water or wind into nearby storm drain inlets, channels, and/or streams.

Approach

Preventive measures including enclosures, containment structures, and impervious pavements to mitigate spills, should be used to reduce the likelihood of contamination.

Suitable Applications

Appropriate applications include residential, commercial, and industrial areas planned for development or redevelopment. Detached residential single-family homes are typically excluded from this requirement.

Design Considerations

Design requirements for waste handling areas are governed by Building and Fire Codes, and by current local agency ordinances and zoning requirements. The design criteria described in this fact sheet are meant to enhance and be consistent with these code and ordinance requirements. Hazardous waste should be handled in accordance with legal requirements established in Hawaii Administrative Rules Title 11 Chapter 58.1 Solid Waste Management Control, and enforcement by the State of Hawaii Department of Health Solid and Hazardous Waste Branch.

Wastes from commercial and industrial sites are typically hauled by either public or commercial carriers that may have design or access requirements for waste storage areas. The design criteria in this fact sheet are recommendations and are not intended to be in conflict with requirements established by the waste hauler. The waste hauler should be contacted prior to the design of your site trash collection areas. Conflicts or issues should be discussed with the local agency.

Design Guidelines

- Hazardous waste must be handled in accordance with legal requirements established in Hawaii Administrative Rules Title 11 Chapter 58.1 Solid Waste Management Control, and enforcement by the State of Hawaii Department of Health solid and Hazardous Waste Branch.
- Berm trash storage areas to prevent run-on from adjoining roofs and pavement, or grade areas towards vegetated/landscaped areas.
- Reduce/prevent leaking of liquid waste by incorporating at least one of the following:
 - Lined bins or dumpsters.
 - Low containment berm around the dumpster area.
 - Drip pans underneath dumpsters.
- Prevent rainfall from entering containers with roofs, awnings, or attached lids.
- Pave trash storage areas with an impervious surface to mitigate spills.
- Do not locate storm drains in immediate vicinity of the trash storage area.
- Post signs on dumpsters indicating that hazardous material are not to be disposed of therein.

Designing New Installations

Trash storage areas should be designed to consider the following structural or treatment control BMPs:

- Design trash container areas so that drainage from adjoining roofs and pavement is diverted around the area(s) to avoid run-on. This might include berming or grading the waste handling area to prevent run-on of storm water.
- Make sure trash container areas are screened or walled to prevent off-site transport of trash.
- Use lined bins or dumpsters to reduce leaking of liquid waste.
- Provide roofs, awnings, or attached lids on all trash containers to minimize direct precipitation and prevent rainfall from entering containers.
- Pave trash storage areas with an impervious surface to mitigate spills.
- Do not locate storm drains in immediate vicinity of the trash storage area.
- Post signs on all dumpsters informing users that hazardous material are not to be disposed of therein.

Redeveloping Existing Installations

The City's SWMPP defines "redevelopment" as development that would create or add impervious surface area on an already developed site. The definition of "redevelopment" must be consulted to determine whether or not the requirements for new development apply to areas intended for redevelopment. If the definition applies, the steps outlined under "designing new installations" above should be followed.

Supplemental Information

Maintenance Considerations

The integrity of structural elements that are subject to damage (i.e., screens, covers, and signs) must be maintained by the owner/operator. Maintenance agreements between the local agency and the owner/ operator may be required. Some agencies will require maintenance deed restrictions to be recorded of the property title. If required by the local agency, maintenance agreements or deed restrictions must be executed by the owner/operator before improvement plans are approved.

O&M Recommendations

- Spot clean leaks and drips routinely to prevent runoff of spillage.
- Post “no littering” signs.
- Use only watertight waste receptacle(s) and keep the lid(s) closed.
- Do not overfill or fill with any liquid. Keep lid closed at all times.
- Periodically inspect for leaks. If found contact the leasing company immediately.
- Never wash down or rinse with a hose. Contact leasing company for cleaning.
- Develop and implement a Spill Prevention Control and Countermeasure (SPCC) Plan.

References

California Stormwater Quality Association (CASQA) Best Management Practices Handbook New Development and Redevelopment, 2003.

Hawaii Administrative Rules Title 11 Chapter 58.1 Solid Waste Management Control, Honolulu Hawaii Department of Health, 2003: <http://health.hawaii.gov/shwb/files/2013/06/11-5811.pdf>

A Manual for the Standard Urban Stormwater Mitigation Plan (SUSMP), Los Angeles County Department of Public Works, May 2002.

Model Standard Urban Storm Water Mitigation Plan (SUSMP) for San Diego County, Port of San Diego, and Cities in San Diego County, February 14, 2002.

Model Water Quality Management Plan (WQMP) for County of Orange, Orange County Flood Control District, and the Incorporated Cities of Orange County, Draft February 2003.

Ventura Countywide Technical Guidance Manual for Stormwater Quality Control Measures, July 2002.

This page is intentionally left blank.

SC-11: Outdoor Material Storage



Design Objectives	
	Maximum Infiltration
	Provide On-Site Retention
	Slow Runoff
	Minimize Impervious Land Coverage
	Implement LID
	Prohibit Dumping of Improper Materials
✓	Contain Pollutants
✓	Collect and Convey

Description

Proper design of outdoor storage areas for materials reduces opportunity for pollutants to enter the storm water conveyance system. Materials may be in the form of raw products, by-products, finished products, and waste products.

Approach

Outdoor storage areas require a drainage approach different from the typical infiltration/detention strategy. In outdoor storage areas, infiltration is discouraged and containment is encouraged. Preventative measures include enclosures, secondary containment structures and impervious surfaces.

Suitable Applications

Appropriate applications include residential, commercial and industrial areas planned for development or redevelopment.

Design Considerations

Some materials are more of a concern than others. Toxic and hazardous materials must be prevented from coming in contact with storm water. Non-toxic or non-hazardous materials do not have to be prevented from storm water contact. However, these materials may have toxic effects on receiving waters if allowed to be discharged with storm water in significant quantities. Accumulated material on an impervious surface could result in significant impact on the rivers or streams that receive the runoff.

Material may be stored in a variety of ways, including bulk piles, containers, shelving, stacking, and tanks. Storm water contamination may be prevented by eliminating the possibility of storm water contact with the material storage areas either through diversion, cover, or capture of the storm water. Control measures may also include minimizing the storage area. Design requirements for material storage areas are governed by Building and Fire Codes, and by current City ordinances and zoning requirements. Control measures are site specific, and must meet local agency requirements.

Design Guidelines

Design requirements for material storage areas are governed by Building and Fire Codes, and by current City ordinances and zoning requirements. Control measures are site specific, and must meet local agency requirements.

- Materials with the potential to contaminate storm water must either be placed in an enclosure that prevents contact with runoff or spillage to the storm water conveyance system, or protected by secondary containment structures such as berms, dikes, or curbs.
- Pave the storage area with Portland cement concrete (or equivalent smooth impervious surface) to contain leaks and spills.
- Slope the storage area towards a dead-end sump to contain spills.
- Direct runoff from downspouts/roofs away from storage areas.
- Cover the storage area with an awning that extends beyond the storage area to minimize collection of storm water within the secondary containment area. A manufactured storage shed may be used for small containers.

Designing New Installations

Where proposed project plans include outdoor areas for storage of materials that may contribute pollutants to the storm water conveyance system, the following structural or treatment BMPs should be considered:

- Materials with the potential to contaminate storm water should be:
 - Placed in an enclosure such as, but not limited to, a cabinet, shed, or similar structure that prevents contact with runoff or spillage to the storm water conveyance system, or
 - Protected by secondary containment structures such as berms, dikes, or curbs.
- The storage area should be paved and sufficiently impervious to contain leaks and spills.
- The storage area should slope towards a dead-end sump to contain spills and direct runoff from downspouts/roofs should be directed away from storage areas.
- The storage area should have a roof or awning that extends beyond the storage area to minimize collection of storm water within the secondary containment area. A manufactured storage shed may be used for small containers.

Note that the location(s) of installations of where these preventative measures will be employed must be included on the map or plans identifying BMPs.

Redeveloping Existing Installations

The City's SWMPP defines "redevelopment" as development that would create or add impervious surface area on an already developed site. The definition of "redevelopment" must be consulted to determine whether or not the requirements for new development apply to areas intended for redevelopment. If the definition applies, the steps outlined under "designing new installations" above should be followed.

Supplemental Information

Storm water and non-storm water will accumulate in containment areas and sumps with impervious surfaces. Contaminated accumulated water must be disposed of in accordance with applicable laws and cannot be discharged directly to the storm drain or sanitary sewer system without the appropriate permits.

O&M Recommendations

- Protect materials from rainfall, run-on, runoff, and wind dispersal.
- Employ safeguards against accidental releases.
- Inspect storage areas regularly for leaks or spills.
- Keep storage areas clean and dry.
- Keep containers in good condition without corrosion or leaky seams.
- Cover and contain stockpiles of raw materials to prevent storm water run-on. If infeasible, implement erosion control practices around site perimeter and catch basins.
- Develop and implement a Spill Prevention Control and Countermeasure (SPCC) Plan.

References

California Stormwater Quality Association (CASQA) Best Management Practices Handbook New Development and Redevelopment, 2003.

A Manual for the Standard Urban Stormwater Mitigation Plan (SUSMP), Los Angeles County Department of Public Works, May 2002.

Model Standard Urban Storm Water Mitigation Plan (SUSMP) for San Diego County, Port of San Diego, and Cities in San Diego County, February 14, 2002.

Model Water Quality Management Plan (WQMP) for County of Orange, Orange County Flood Control District, and the Incorporated Cities of Orange County, Draft February 2003.

Ventura Countywide Technical Guidance Manual for Stormwater Quality Control Measures, July 2002.

This page is intentionally left blank.

SC-12: Outdoor Work Areas



Design Objectives	
	Maximum Infiltration
	Provide On-Site Retention
	Slow Runoff
	Minimize Impervious Land Coverage
	Implement LID
	Prohibit Dumping of Improper Materials
✓	Contain Pollutants
✓	Collect and Convey

Description

Proper design of outdoor work areas (grinding, painting, coating, sanding, parts cleaning, etc.) reduces opportunity for pollutants to enter the storm water conveyance system.

Approach

In outdoor work areas, infiltration and discharge to the storm drain are discouraged; collection and conveyance to the sanitary sewer are encouraged.

Suitable Applications

Appropriate applications include residential, commercial, and industrial areas planned for development or redevelopment.

Design Considerations

Design requirements for outdoor work areas are governed by Building and Fire Codes, and by current City ordinances, and zoning requirements.

Design Guidelines

Design requirements for outdoor work areas are governed by Building and Fire Codes, and by current City ordinances, and zoning requirements.

- Create an impermeable surface such as concrete or asphalt, or a prefabricated metal drip pan, depending on the use.
- Cover the area with a roof to prevent rain from falling on the work area and becoming polluted runoff.
- Berm or perform mounding around the perimeter of the area to prevent water from adjacent areas from flowing on to the surface of the work area.

- Directly connect runoff to the sanitary sewer or other specialized containment system(s). This allows the more highly concentrated pollutants from these areas to receive special treatment that removes particular constituents. Approval for this connection must be obtained from the City.
- Locate the work area away from storm drains or catch basins.

Designing New Installations

Outdoor work areas can be designed in particular ways to reduce impacts on both storm water quality and sewage treatment plants.

- Create an impermeable surface such as concrete or sealed asphalt, or a prefabricated metal drip pan, depending on the use.
- Cover the area with a roof. This prevents rain from falling on the work area and becoming polluted runoff.
- Berm or perform mounding around the perimeter of the area to prevent water from adjacent areas from flowing on to the surface of the work area.
- Directly connect runoff. Unlike other areas, runoff from work areas is directly connected to the sanitary sewer or other specialized containment system(s). This allows the more highly concentrated pollutants from these areas to receive special treatment that removes particular constituents. Approval for this connection must be obtained from the appropriate sanitary sewer agency.
- Locate the work area away from storm drains or catch basins.

Redeveloping Existing Installations

The City's SWMPP defines "redevelopment" as development that would create or add impervious surface area on an already developed site. The definition of "redevelopment" must be consulted to determine whether or not the requirements for new development apply to areas intended for redevelopment. If the definition applies, the steps outlined under "designing new installations" above should be followed.

O&M Recommendations

- Dry clean the work area regularly.
- Inspect storage areas regularly for leaks or spills.
- Develop and implement a Spill Prevention Control and Countermeasure (SPCC) Plan.

References

California Stormwater Quality Association (CASQA) Best Management Practices Handbook New Development and Redevelopment, 2003.

A Manual for the Standard Urban Stormwater Mitigation Plan (SUSMP), Los Angeles County Department of Public Works, May 2002.

Model Standard Urban Storm Water Mitigation Plan (SUSMP) for San Diego County, Port of San Diego, and Cities in San Diego County, February 14, 2002.

Model Water Quality Management Plan (WQMP) for County of Orange, Orange County Flood Control District, and the Incorporated Cities of Orange County, Draft February 2003.

Ventura Countywide Technical Guidance Manual for Stormwater Quality Control Measures, July 2002.

This page is intentionally left blank.

SC-13: Outdoor Process Equipment Operations



Design Objectives	
	Maximum Infiltration
	Provide On-Site Retention
	Slow Runoff
	Minimize Impervious Land Coverage
	Implement LID
	Prohibit Dumping of Improper Materials
✓	Contain Pollutants
✓	Collect and Convey

Description

Outdoor process equipment operations such as rock grinding or crushing, painting or coating, grinding or sanding, degreasing or parts cleaning, may contribute a variety of pollutants to the storm conveyance system.

Approach

In outdoor process equipment areas, infiltration is discouraged and containment is encouraged, accompanied by collection and conveyance.

Suitable Applications

Appropriate applications include commercial and industrial areas planned for development or redevelopment.

Design Considerations

Design requirements for outdoor processing areas are governed by Building and Fire codes, and by current local agency ordinances, and zoning requirements.

Design Guidelines

Design requirements for outdoor processing areas are governed by Building and Fire codes, and by current local agency ordinances, and zoning requirements.

- Cover or enclose areas that would be the most significant source of pollutants; or slope the area toward a dead-end sump; or, discharge to the sanitary sewer system following appropriate treatment in accordance with conditions established by the applicable sewer agency.
- Grade or berm area to prevent run-on from surrounding areas.
- Do not install storm drains in areas of equipment repair.

- Provide secondary containment structures (not double wall containers) where wet material processing occurs (e.g., electroplating), to hold spills resulting from accidents, leaking tanks, or equipment, or any other unplanned releases. Note: if these are plumbed to the sanitary sewer, they must be with the prior approval of the City.

Designing New Installations

Operations determined to be a potential threat to water quality should consider to the following recommendations:

- Cover or enclose areas that would be the most significant source of pollutants; or slope the area toward a dead-end sump; or, discharge to the sanitary sewer system following appropriate treatment in accordance with conditions established by the applicable sewer agency.
- Grade or berm area to prevent run-on from surrounding areas.
- Do not install storm drains in areas of equipment repair.
- Consider other features that are comparable or equally effective.
- Provide secondary containment structures (not double wall containers) where wet material processing occurs (i.e., electroplating), to hold spills resulting from accidents, leaking tanks, or equipment, or any other unplanned releases. Note: if these are plumbed to the sanitary sewer, they must be with the prior approval of the City or other applicable sanitary sewer agency.

Redeveloping Existing Installations

The City's SWMPP defines "redevelopment" as development that would create or add impervious surface area on an already developed site. The definition of "redevelopment" must be consulted to determine whether or not the requirements for new development apply to areas intended for redevelopment. If the definition applies, the steps outlined under "designing new installations" above should be followed.

Supplemental Information

Storm water and non-storm water will accumulate in containment areas and sumps with impervious surfaces. Contaminated accumulated water must be disposed of in accordance with applicable laws and cannot be discharged directly to the storm drain or sanitary sewer system without the appropriate permit.

O&M Recommendations

- Dry clean the work area regularly.
- Inspect storage areas regularly for leaks or spills.
- Develop and implement a Spill Prevention Control and Countermeasure (SPCC) Plan.

References

California Stormwater Quality Association (CASQA) Best Management Practices Handbook New Development and Redevelopment, 2003.

A Manual for the Standard Urban Storm Water Mitigation Plan (SUSMP), Los Angeles County Department of Public Works, May 2002.

Model Standard Urban Storm Water Mitigation Plan (SUSMP) for San Diego County, Port of San Diego, and Cities in San Diego County, February 14, 2002.

Model Water Quality Management Plan (WQMP) for County of Orange, Orange County Flood Control District, and the Incorporated Cities of Orange County, Draft February 2003.

Ventura Countywide Technical Guidance Manual for Stormwater Quality Control Measures, July 2002.

This page is intentionally left blank.

SC-14: Parking Areas



Design Objectives	
✓	Maximum Infiltration
✓	Provide On-Site Retention
✓	Slow Runoff
✓	Minimize Impervious Land Coverage
✓	Implement LID
	Prohibit Dumping of Improper Materials
	Contain Pollutants
	Collect and Convey

Description/Approach

Parking lots and storage areas can contribute a number of substances, such as trash, suspended solids, hydrocarbons, oil and grease, and heavy metals that can enter receiving waters through storm water runoff or non-storm water discharges. The protocols in this fact sheet are intended to prevent or reduce the discharge of pollutants from parking/storage areas.

Design Guidelines

Direct pavement runoff towards vegetated/landscaped areas if possible.

O&M Recommendations

- Clean leaves, trash, sand, and other debris regularly.
- Routinely sweep, shovel, and dispose of litter in the trash. Sweep entire parking lot at least once before the onset of the wet season.
- Provide an adequate number of covered trash receptacles. Clean out frequently.
- Re-seal or pave only on dry days, and stop immediately before rainfall.
- Pre-heat, transfer or load hot bituminous material away from storm drain inlets.
- Do not allow any solids, liquids, or slurries to enter storm drains.
- Use dry clean-up methods (absorbents) on auto spills and/or drips.
- Do not hose down unless absolutely necessary. If you must pressure wash, discharge wash water to the sanitary sewer or a vegetated area. Do not allow wash water to enter storm drains.

This page is intentionally left blank.

Appendix B: Treatment Control BMP Fact Sheets

On the following pages are fact sheets for each Treatment Control BMP specified in the *Water Quality Rules*. The following information is provided for each BMP:

- Brief description
- BMP category
- Expected pollutant removals
- Minimum design criteria
- Feasibility criteria
- Step-by-step sizing procedure
- Pretreatment considerations
- Area requirements
- Sizing example
- Other design considerations
- Typical schematic
- General maintenance rank and requirements

The sizing procedures are based on simple dynamic and static principles and therefore may result in larger BMPs than are necessary. More rigorous sizing methods (such as detailed routing methods or continuous simulation models) may be used with City approval. Sizing worksheets are available on the DPP's website.

BMPs not included herein, such as Stormwater wetlands, wet ponds, and proprietary devices, may be used with written City approval.

This page is intentionally left blank.

TC-01: Infiltration Basin



Halawa District Park

BMP Category	
Retention	●
Biofiltration	○
Other	○

O&M Requirements
Medium

Expected Pollutant Removals			
Nutrients	High	Pesticides	High
Sediment	High	Oil & Grease	High
Trash	High	Metals	High
Pathogens	High	Organic Compounds	High

Description

An infiltration basin is a shallow impoundment with no outlet, where storm water runoff is stored and infiltrates through the basin invert and into the soil matrix.

Minimum Design Criteria

Design Parameter	Units	Value
Invert Slope	percent	0
Maximum Interior Side Slope (length per unit height)		3:1
Drawdown (drain) Time	hours	48
Minimum Soil Infiltration Rate	inches/hour	0.5
Minimum Freeboard	feet	1.0
Minimum Depth from Basin Invert to Groundwater Table	feet	3

Feasibility Criteria

See Section 5.5: Feasibility Criteria.

Sizing Procedure

- Step 1. Use the procedure presented previously to compute the Volumetric Runoff Coefficient and WQV.

Step 2. Calculate the maximum allowable water storage depth (d_{max}) using the underlying soil infiltration rate (k) and the required drawdown time (t):

$$d_{max} = kt / (F_s \times 12)$$

Where d_{max} = Maximum Storage Depth (ft)
 k = Soil Infiltration Rate (in/hr)
 t = Drawdown (drain) Time (hrs)
 F_s = Infiltration Rate Factor of Safety (see Section 5)

Step 3. Select a design ponding depth no greater than the maximum allowable depth calculated in Step 2.

$$d_p \leq d_{max}$$

Where d_p = Design Ponding Depth (ft)
 d_{max} = Maximum Storage Depth from Step 2 (ft)
 k = Soil Infiltration Rate (in/hr)

Step 4. Calculate the basin bottom surface area (A_b):

$$A_b = WQV / (d_p + kT / 12F_s)$$

Where A_b = Bottom Surface Area (sq-ft)
 WQV = WQV from Step 1 (cu-ft)
 d_p = Design Ponding Depth from Step 3 (ft)
 k = Soil Infiltration Rate (in/hr)
 T = Fill Time (time for the BMP to fill with water [hrs])
 F_s = Infiltration Rate Factor of Safety (see Section 5)

Step 5. Select a basin bottom width (w_b), and calculate the basin bottom length (l_b):

$$l_b = A_b / w_b$$

Where l_b = Bottom Length (ft)
 A_b = Bottom Surface Area from Step 4 (sq-ft)
 w_b = Bottom Width (ft)

Step 6. Calculate the total area occupied by the BMP excluding pretreatment (A_{BMP}) using the basin bottom dimensions, embankment side slopes, and freeboard:

$$A_{BMP} = [W_b + 2z(d_p + f)] \times [l_b + 2z(d_p + f)]$$

Where	A_{BMP}	=	Area Occupied by BMP Excluding Pretreatment (sq-ft)
	w_b	=	Bottom Width from Step 5 (ft)
	z	=	Basin Interior Side Slope (length per unit height)
	d_p	=	Design Ponding Depth from Step 3 (ft)
	f	=	Freeboard (ft)
	l_b	=	Bottom Length from Step 5 (ft)

If the calculated area does not fit in the available space, either reduce the drainage area, increase the ponding depth (if it's not already set to the maximum depth), and/or reduce the Infiltration Rate Factor of Safety (if minimum number of test pits and permeability tests have not been performed) and repeat the calculations.

Pretreatment Considerations

Infiltration facilities are highly susceptible to clogging and premature failure from sediment, trash, and other materials. Suitable pretreatment systems maintain the infiltrate rate of the device without frequent and intensive maintenance. For measured soil infiltration rates below 3 in/hr, pretreatment is strongly recommended, and the pretreatment device should be sized for at least 25% of the WQV. For measured soil infiltration rates greater than 3 in/hr, pretreatment is mandatory to minimize groundwater contamination risks, and the pretreatment device must be sized for at least 50% of the WQV if the measured soil infiltration rate is below 5 in/hr and 100% of the WQV if the measured soil infiltration rate is greater than 5 in/hr. Pretreatment may be achieved with vegetated swales, vegetated filter strips, sedimentation basins or forebays, sedimentation manholes, and manufactured treatment devices.

Area Requirements

An infiltration basin requires a footprint equivalent to 7% - 20% of its contributing impervious drainage area, excluding pretreatment. The lower value reflects the maximum allowable infiltration rate and minimum allowable factor of safety, while the upper value reflects the minimum allowable infiltration rate and maximum allowable factor of safety.

Sizing Example

Calculate the size of an infiltration basin serving a 1-acre residential development. Assume the following design parameters:

Design Parameter	Units	Value
Percent Impervious Cover, I	%	70
Design Storm Depth, P	inches	1
Basin Fill Time, T	hours	2
Drawdown (drain) Time, t	hours	48
Basin Interior Side Slope (length per unit height), z		3

Design Parameter	Units	Value
Soil Infiltration Rate, k	inches/hour	1.0
Infiltration Rate Factor of Safety, F_s		2
Freeboard, f	feet	1

1. Calculate the volumetric runoff coefficient (C) and WQV:

$$C = 0.05 + 0.009I$$

$$C = 0.05 + 0.009 \times 70$$

$$C = 0.68$$

$$WQV = PCA \times 3630$$

$$WQV = 1 \times 0.68 \times 1 \times 3630$$

$$WQV = 2,468 \text{ cu-ft}$$

2. Calculate the maximum allowable water storage depth of the infiltration trench (d_{\max}):

$$d_{\max} = kt/12F_s$$

$$d_{\max} = 1.0 \times 48/(12 \times 2)$$

$$d_{\max} = 2.0 \text{ ft}$$

3. Select a ponding depth (d_p) is no greater than the maximum allowable depth:

$$d_p = 2.0 \text{ ft}$$

4. Calculate the basin bottom surface area (A_b):

$$A_b = WQV/(d_p + kT/12F_s)$$

$$A_b = 2,468/[2.0 + 1.0 \times 2.0/(12 \times 2)]$$

$$A_b = 1,185 \text{ sq-ft}$$

5. Set the basin bottom width (w_b) to 25 ft, and calculate the basin bottom length (l_b):

$$l_b = A_b/W_b$$

$$l_b = 1,185/25$$

$$l_b = 47.4 \text{ ft}$$

6. Calculate the total area excluding pretreatment (A_{BMP}):

$$A_{\text{BMP}} = [w_b + 2z(d_p + f)] \times [l_b + 2z(d_p + f)]$$

$$A_{\text{BMP}} = [25 + 2 \times 3(2 + 1)] \times [47.4 + 2 \times 3(2 + 1)]$$

$$A_{\text{BMP}} = 2,812 \text{ sq-ft}$$

Other Design Considerations

- If a temporarily-filled pond creates a potential public safety issue, perimeter fencing may be considered. A vegetative screen around the basin to restrict direct view from adjacent properties may improve the aesthetics of the site and public acceptance of the facility.
- If feasible, include vehicle access to the basin invert for maintenance.
- If the area around the basin has a recreational use, a safety shelf around the perimeter of the basin can be included for times when the basin is flooded.
- The infiltration basin should be designed with an outlet structure to pass peak flows during a range of storm events, as well as with an emergency spillway to pass peak flows around the embankment during extreme storm events that exceed the combined infiltration capacity and outlet structure capacity of the facility.
- To help ensure maintenance of the design permeability rate over time, a 6-inch layer of sand may be placed on the bottom of an infiltration basin. This sand layer can intercept silt, sediment, and debris that could otherwise clog the top layer of the soil below the basin. The sand layer will also facilitate silt, sediment, and debris removal from the basin and can be readily restored following removal operations.
- Observation wells are recommended. They will indicate how quickly the basin dewateres following a storm and it will provide a method of observing how quickly the basin fills up with sediments.

Construction/Inspection Considerations

- Before construction begins, stabilize the entire area draining to the facility. If impossible, place a diversion berm around the perimeter of the infiltration site to prevent sediment entrance during construction or remove the top two (2) inches of soil after the site is stabilized. Stabilize the entire contributing drainage area, including the side slopes, before allowing any runoff to enter once construction is complete.
- Place excavated material such that it cannot be washed back into the basin if a storm occurs during construction of the facility.
- Build the basin without driving heavy equipment over the infiltration surface. Any equipment driven on the surface should have extra-wide (“low pressure”) tires. Prior to any construction, rope off the infiltration area to stop entrance by unwanted equipment.
- After final grading, till the infiltration surface deeply.
- Use appropriate erosion control seed mix for the specific project and location.

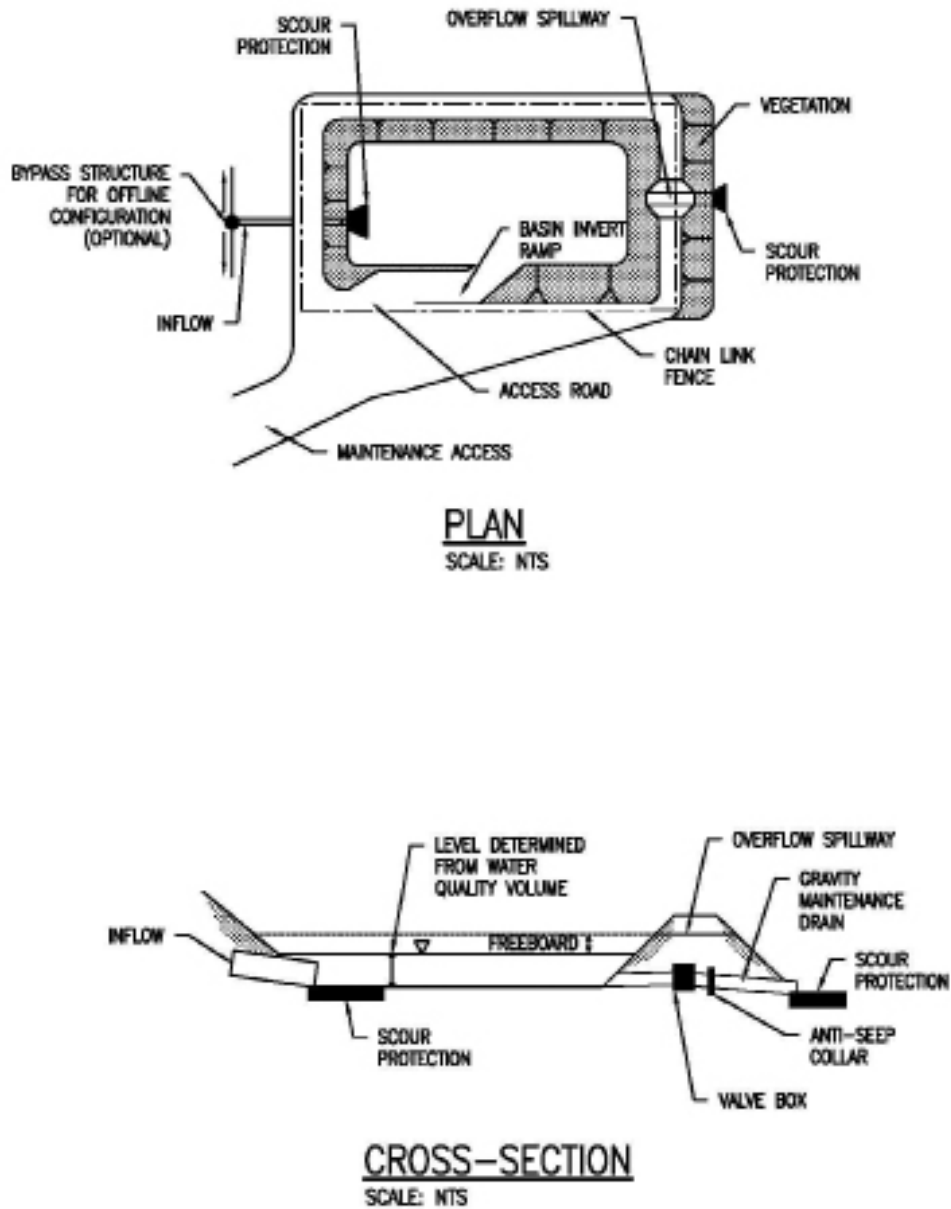

Schematic of an Infiltration Basin

TC-02: Infiltration Trench



BMP Category	
Retention	●
Biofiltration	○
Other	○

O&M Requirements
Medium

Expected Pollutant Removals			
Nutrients	High	Pesticides	High
Sediment	High	Oil & Grease	High
Trash	High	Metals	High
Pathogens	High	Organic Compounds	High

City of Bellingham, WA (source: cob.org/services/environment/lake-whatcom)

Description

An infiltration trench is a rock-filled trench with no outlet, where storm water runoff is stored in the void space between the rocks and infiltrates through the bottom and into the soil matrix.

Minimum Design Criteria

Design Parameter	Units	Value
Maximum Trench Depth	feet	8
Maximum Trench Width	feet	25
Maximum Top Backfill Layer Thickness	inches	6
Maximum Bottom Sand Layer Thickness	inches	12
Drawdown (drain) Time	hours	48
Minimum Soil Infiltration Rate	inches/hour	0.5
Trench Rock Size	inches	1.5 – 3.0
Minimum Depth from trench invert to groundwater table	feet	3

Feasibility Criteria

See Section 5.5: Feasibility Criteria.

Sizing Procedure

- Step 1. Use the procedure presented previously to compute the Volumetric Runoff Coefficient and WQV.

Step 2. Calculate the maximum allowable water storage depth (d_{max}) using the underlying soil infiltration rate (k) and the required drawdown time (t):

$$d_{max} = kt / (F_s \times 12)$$

Where d_{max} = Maximum Storage Depth (ft)
 k = Soil Infiltration Rate (in/hr)
 t = Drawdown (drain) Time (hrs)
 F_s = Infiltration Rate Factor of Safety (see Section 5)

Step 3. Select a ponding depth (optional), trench rock (or alternative material) depth, and sand layer depth (optional) such that the total effective storage depth is no greater than the maximum allowable depth calculated in Step 2:

$$d_t = d_p + l_b n_b + l_s n_s \leq d_{max}$$

Where d_t = Total Effective Water Storage Depth (ft)
 d_p = Ponding Depth (ft)
 l_b = Backfill Material Thickness Depth (ft)
 n_b = Backfill Material Porosity
 l_s = Sand Layer Thickness Depth (ft)
 n_s = Sand Porosity
 d_{max} = Maximum Storage Depth from Step 2 (ft)

Step 4. Calculate the trench surface area (A_{BMP}):

$$A_{BMP} = WQV / (d_t + kT / 12F_s)$$

Where A_{BMP} = BMP Surface Area excluding Pretreatment (sq-ft)
 WQV = WQV from Step 1 (cu-ft)
 d_t = Total Effective Water Storage Depth from Step 3 (ft)
 k = Soil Infiltration Rate (in/hr)
 T = Fill Time (time for the BMP to fill with water [hrs])
 F_s = Infiltration Rate Factor of Safety (see Section 5)

If the calculated area does not fit in the available space, either reduce the drainage area, increase the ponding depth or trench rock depth or sand layer depth (if the total effective depth is not already equal to the maximum depth), and/or reduce the Infiltration rate factor of safety (if minimum number of test pits and permeability tests have not been performed) and repeat the calculations.

Pretreatment Considerations

Infiltration facilities are highly susceptible to clogging and premature failure from sediment, trash, and other materials. Suitable pretreatment systems maintain the infiltrate rate of the device without

frequent and intensive maintenance. For measured soil infiltration rates below 3 in/hr, pretreatment is strongly recommended, and the pretreatment device should be sized for at least 25% of the WQV. For measured soil infiltration rates greater than 3 in/hr, pretreatment is mandatory to minimize groundwater contamination risks, and the pretreatment device must be sized for at least 50% of the WQV if the measured soil infiltration rate is below 5 in/hr and 100% of the WQV if the measured soil infiltration rate is greater than 5 in/hr. Pretreatment may be achieved with vegetated swales, vegetated filter strips, sedimentation basins or forebays, sedimentation manholes, and manufactured treatment devices.

Area Requirements

An infiltration trench requires a footprint equivalent to 2% - 20% of its contributing impervious drainage area, excluding pretreatment. The lower value reflects the maximum allowable infiltration rate, minimum allowable factor of safety, and minimal ponding, while the upper value reflects the minimum allowable infiltration rate, maximum allowable factor of safety, and no ponding.

Sizing Example

Calculate the size of an infiltration basin serving a 1-acre residential development. Assume the following design parameters:

Design Parameter	Units	Value
Percent Impervious Cover, I	percent	70
Design Storm Depth, P	inches	1
Trench Fill Time, T	hours	2
Drawdown (drain) Time, t	hours	48
Backfill porosity, n_b		0.35
Sand porosity, n_s		0.40
Soil Infiltration Rate, k	inches/hour	1
Infiltration Rate Factor of Safety, F_s		2

1. Calculate the volumetric runoff coefficient (C) and WQV:

$$C = 0.05 + 0.009I$$

$$C = 0.05 + 0.009 \times 70$$

$$C = 0.68$$

$$WQV = PCA \times 3630$$

$$WQV = 1 \times 0.68 \times 1 \times 3630$$

$$WQV = 2,468 \text{ cu-ft}$$

2. Calculate the maximum allowable water storage depth in the basin (d_{\max}):

$$d_{\max} = kT/12F_s$$

$$d_{\max} = 1.0 \times 48/(12 \times 2)$$

$$d_{\max} = 2.0 \text{ ft}$$

3. Select a design ponding depth (d_p), trench rock depth (d_r), and optional sand layer depth (d_s) such that the total effective storage depth (d_t) is no greater than the maximum allowable depth:

$$d_p = 0.0 \text{ ft}$$

$$l_b = 5.0 \text{ ft}$$

$$l_s = 0.5 \text{ ft}$$

$$d_t = d_p + l_b n_b + l_s n_s$$

$$d_t = 0.0 + 5.0 \times 0.35 + 0.5 \times 0.40$$

$$d_t = 1.95 \text{ ft}$$

4. Calculate the BMP surface area excluding pretreatment (A_{BMP}):

$$A_{\text{BMP}} = WQV / (d_t + kT / 12F_s)$$

$$A_{\text{BMP}} = 2,468 / [1.95 + 1.0 \times 2.0 / (12 \times 2)]$$

$$A_{\text{BMP}} = 1,214 \text{ sq-ft}$$

Other Design Considerations

- Observation wells are recommended at 50 ft intervals over the length of the infiltration trench. They will indicate how quickly the trench dewater following a storm and it will provide a method of observing how quickly the trench fills up with sediments.
- Infiltration trenches should not be deeper than the longest surface area dimension. Otherwise, they meet the USEPA definition of Class V Injection Wells under the federal Underground Injection Control (UIC) Program, and are subject to applicable federal and state requirements.
- Vegetation may be planted over the infiltration trench provided that adequate soil media is provided above the trench.
- There must be an overflow route for storm water flows that overtop the facility or in case the infiltration facility becomes clogged.

Construction/Inspection Considerations

Stabilize the entire area draining to the infiltration before construction begins. If impossible, place a diversion berm around the perimeter of the infiltration site to prevent sediment entrance during construction.

Stabilize the entire contributing drainage area before allowing any runoff to enter once construction is complete.

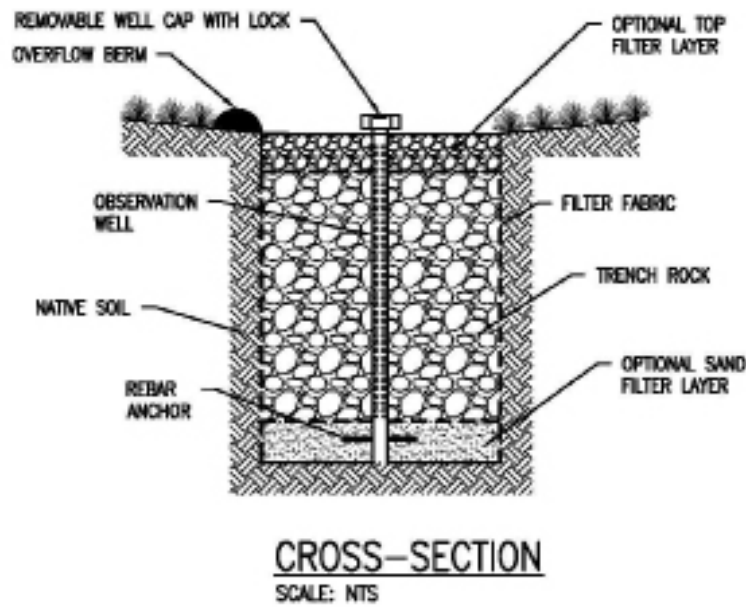
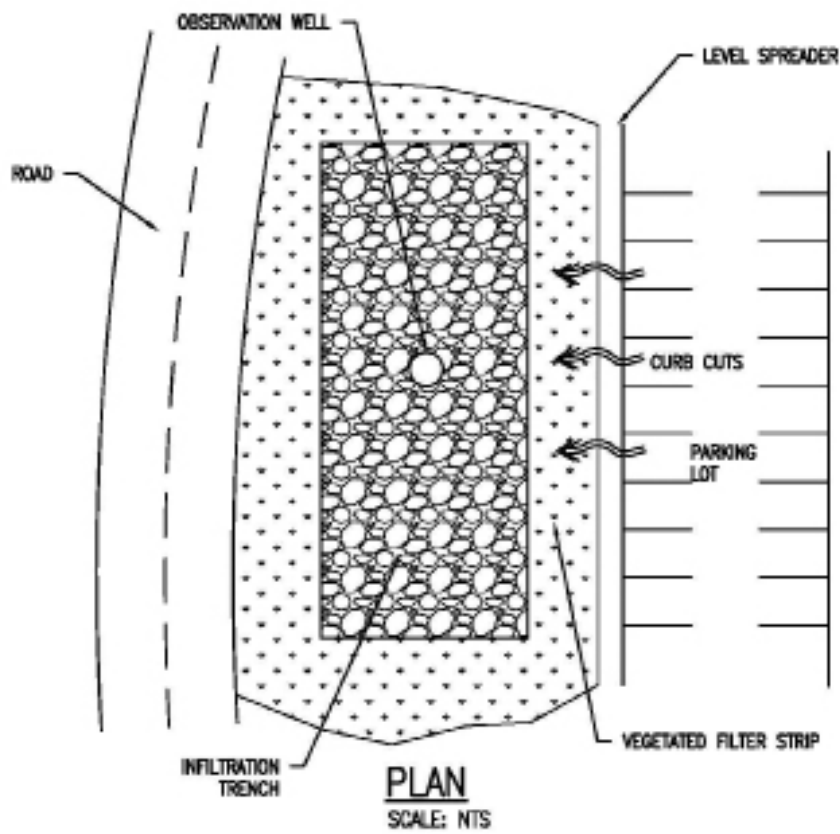

Schematic of an Infiltration Trench

This page is intentionally left blank.

TC-03: Subsurface Infiltration



Kroc Community Center, Kapolei

BMP Category	
Retention	●
Biofiltration	○
Other	○

O&M Requirements
Medium

Expected Pollutant Removals			
Nutrients	High	Pesticides	High
Sediment	High	Oil & Grease	High
Trash	High	Metals	High
Pathogens	High	Organic Compounds	High

Description

An subsurface infiltration system is a rock storage (or alternative pre-manufactured material) bed below other surfaces such as parking lots, lawns, and playfields for temporary storage and infiltration of runoff.

Minimum Design Criteria

Design Parameter	Units	Value
Drawdown (drain) Time	hours	48
Minimum Soil Infiltration Rate	inches/hour	0.5
Minimum Depth from system invert to groundwater table	feet	3
Any applicable manufacturer's criteria		

Feasibility Criteria

See Section 5.5: Feasibility Criteria.

Sizing Procedure

Follow the manufacturer's guidelines for appropriate sizing calculations and selection of appropriate device/model.

Pretreatment Considerations

Infiltration facilities are highly susceptible to clogging and premature failure from sediment, trash, and other materials. Suitable pretreatment systems maintain the infiltrate rate of the device without frequent and intensive maintenance. For measured soil infiltration rates below 3 in/hr, pretreatment is strongly recommended, and the pretreatment device should be sized for at least 25% of the WQV. For

measured soil infiltration rates greater than 3 in/hr, pretreatment is mandatory to minimize groundwater contamination risks, and the pretreatment device must be sized for at least 50% of the WQV if the measured soil infiltration rate is below 5 in/hr and 100% of the WQV if the measured soil infiltration rate is greater than 5 in/hr. Pretreatment may be achieved with vegetated swales, vegetated filter strips, sedimentation basins or forebays, sedimentation manholes, and manufactured treatment devices.

Area Requirements

The below-grade footprint requirements for commercially-available infiltration chambers vary by manufacturer. However, similarly to above-grade non-proprietary systems, the space will be minimized for sites with higher infiltration rates and lower infiltration rate factors of safety.

Sizing Example

Follow the manufacturer’s guidelines for appropriate sizing calculations and selection of appropriate configuration.

Other Design Considerations

Refer to manufacturer guidelines.

Construction/Inspection Considerations

Refer to manufacturer guidelines.

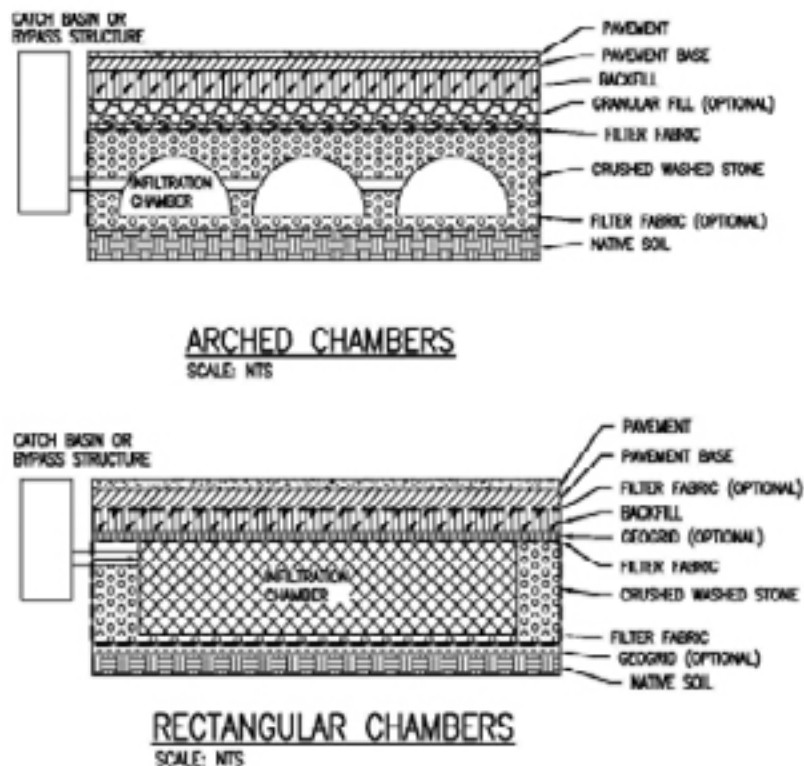

Schematic of a Subsurface Infiltration

TC-04: Dry Well



Courtesy www.brickstoremuseum.org

BMP Category	
Retention	●
Biofiltration	○
Other	○

O&M Requirements
Medium

Expected Pollutant Removals			
Nutrients	High	Pesticides	High
Sediment	High	Oil & Grease	High
Trash	High	Metals	High
Pathogens	High	Organic Compounds	High

Description

A dry well is a subsurface aggregate-filled or prefabricated perforated storage facility, where roof runoff is stored and infiltrates into the soil matrix.

Minimum Design Criteria

Design Parameter	Units	Value
Drawdown (drain) Time	hours	48
Minimum Soil Infiltration Rate	inches/hour	0.5
Aggregate Size (if used)	inches	1.0 - 3.0
Minimum Depth from well invert to groundwater table	feet	3

Feasibility Criteria

See Section 5.5: Feasibility Criteria.

Sizing Procedure

- Step 1. Use the procedure presented previously to compute the Volumetric Runoff Coefficient and WQV.

Step 2. Calculate the maximum allowable water storage depth (d_{max}) using the underlying soil infiltration rate (k) and the required drawdown time (t):

$$d_{max} = kt / (F_s \times 12)$$

Where d_{max} = Maximum Storage Depth (ft)
 k = Soil Infiltration Rate (in/hr)
 t = Drawdown (drain) Time (hrs)
 F_s = Infiltration Rate Factor of Safety (see Section 5)

Step 3. Select a ponding depth (optional) and dry well backfill material depth such that the total effective storage depth is no greater than the maximum allowable depth calculated in Step 2:

$$d_t = d_p + l_b n_b \leq d_{max}$$

Where d_t = Total Effective Water Storage Depth (ft)
 d_p = Ponding Depth (ft)
 l_b = Backfill Material Thickness Depth (ft)
 n_b = Backfill Material Porosity
 d_{max} = Maximum Storage Depth from Step 2 (ft)

Step 4. Calculate the BMP surface area (A_{BMP}):

$$A_{BMP} = WQV / (d_t + kT / 12F_s)$$

Where A_{BMP} = BMP Surface Area (sq-ft)
 WQV = WQV from Step 1 (cu-ft)
 d_t = Total Effective Water Storage Depth from Step 3 (ft)
 k = Soil Infiltration Rate (in/hr)
 T = Fill Time (time for the BMP to fill with water [hrs])
 F_s = Infiltration Rate Factor of Safety (see Section 5)

If the calculated area does not fit in the available space, either reduce the drainage area, increase the ponding depth or rock depth (if the total effective depth is not already equal to the maximum depth), and/or reduce the infiltration rate factor of safety (if minimum number of test pits and permeability tests have not been performed) and repeat the calculations.

Pretreatment Considerations

Roof gutter guards or leaf gutter screens are required for roof runoff to reduce dry well clogging from sediment, leaves, and other organic material. If the dry well receives non-roof runoff, pretreatment must be provided by vegetated swales, vegetated filter strips, or manufactured treatment devices.

Area Requirements

A dry well requires a footprint equivalent to 2% - 20% of its contributing impervious drainage area. The lower value reflects the maximum allowable infiltration rate, minimum allowable factor of safety,

and minimal ponding, while the upper value reflects the minimum allowable infiltration rate, maximum allowable factor of safety, and no ponding.

Sizing Example

Calculate the size of a dry well serving the roof runoff from a 3,000 sq-ft commercial building. Assume the following design parameters:

Design Parameter	Units	Value
Percent Impervious Cover, I	percent	100
Design Storm Depth, P	inches	1.0
Dry Well Fill Time, T	hours	2
Drawdown (drain) Time, t	hours	48
Backfill material porosity, n_b		0.35
Soil Infiltration Rate, k	inches/hour	1.0
Infiltration Rate Factor of Safety, F_s		2

1. Calculate the volumetric runoff coefficient (C) and WQV:

$$C = 0.05 + 0.009I$$

$$C = 0.05 + 0.009 \times 100$$

$$C = 0.95$$

$$WQV = PCA \times 3630$$

$$WQV = 1 \times 0.95 \times (3,000/43,560) \times 3630$$

$$WQV = 238 \text{ cu-ft}$$

2. Calculate the maximum allowable water storage depth in the dry well (d_{\max}):

$$d_{\max} = kt/12F_s$$

$$d_{\max} = 1.0 \times 48/(12 \times 2)$$

$$d_{\max} = 2.0 \text{ ft}$$

3. Select a design ponding depth (d_p) and backfill material depth (l_b) such that the total effective storage depth (d_t) is no greater than the maximum allowable depth:

$$d_p = 0.0 \text{ ft}$$

$$l_b = 5.5 \text{ ft}$$

$$d_t = d_p + l_b n_b$$

$$d_t = 0.0 + 5.5 \times 0.35$$

$$d_t = 1.925 \text{ ft}$$

4. Calculate the BMP surface area:

$$A_{\text{BMP}} = WQV / (d_t + kT / 12F_s)$$

$$A_{\text{BMP}} = 238 / [1.925 + 1.0 \times 2.0 / (12 \times 2)]$$

$$A_{\text{BMP}} = 118 \text{ sq-ft}$$

Other Design Considerations

- Dry wells are typically deeper than they are wide or long, and therefore meet the USEPA definition of Class V Injection Wells under the federal Underground Injection Control (UIC) Program, and are subject to applicable federal and state requirements.
- The dry well must be able to safely convey overflows to either vegetated areas or the storm drain system.
- The design may include an intermediate box with an outflow higher to allow sediments to settle out. Water would then flow through a mesh screen and into the dry well.
- Trees and other large vegetation should be planted away from drywells such that drip lines do not overhang infiltration beds.

Construction/Inspection Considerations

Refer to manufacturer guidelines.

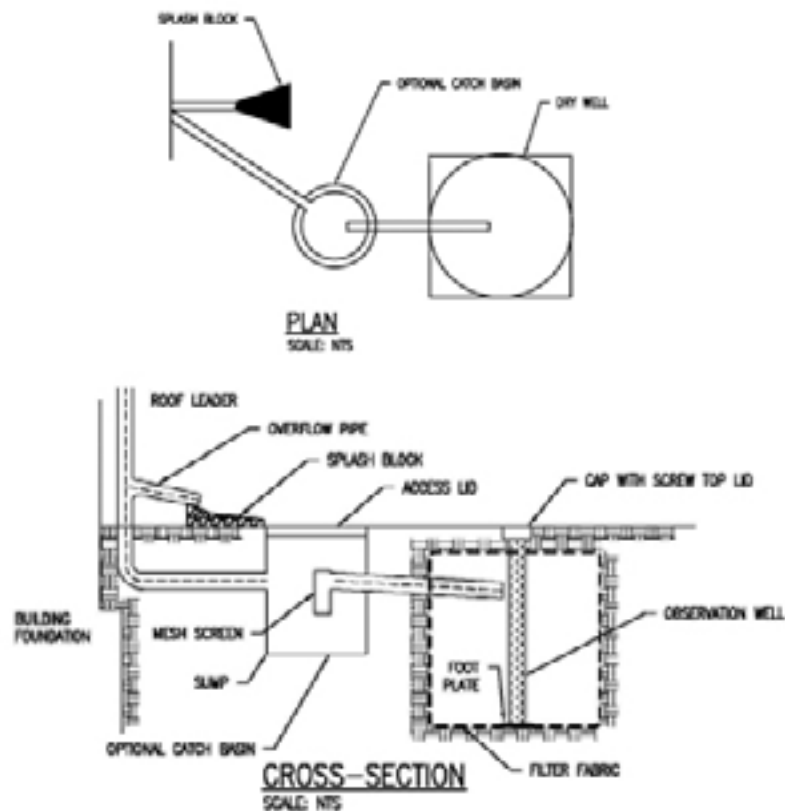

Schematic of a Dry Well

TC-05: Bioretention Basin



Heeiea State Park (www.huihawaii.org)

BMP Category	
Retention	●
Biofiltration	○
Other	○

O&M Requirements
Medium

Expected Pollutant Removals			
Nutrients	High	Pesticides	High
Sediment	High	Oil & Grease	High
Trash	High	Metals	High
Pathogens	High	Organic Compounds	High

Description

Sometimes referred to as a rain garden, a bioretention basin is an engineered shallow depression that collects and filters storm water runoff using conditioned planting soil beds and vegetation. The filtered runoff infiltrates through the basin invert and into the soil matrix.

Minimum Design Criteria

Design Parameter	Units	Value
Mulch Thickness	inches	2 - 4
Planting Soil Depth	feet	2 - 4
Drawdown (drain) Time	hours	48
Maximum Interior Side Slope (length per unit height)		3:1
Maximum Ponding Depth	inches	12
Minimum Depth from basin invert to groundwater table	feet	3
Minimum Freeboard	feet	1.0
Minimum Soil Infiltration Rate	inches/hour	0.5

Feasibility Criteria

See Section 5.5: Feasibility Criteria.

Sizing Procedure

- Step 1. Use the procedure presented previously to compute the Volumetric Runoff Coefficient and WQV.

Step 2. Calculate the maximum allowable water storage depth (d_{max}) using the underlying soil infiltration rate (k) and the required drawdown time (t):

$$d_{max} = kt / (F_s \times 12)$$

Where d_{max} = Maximum Storage Depth (ft)
 k = Soil Infiltration Rate (in/hr)
 t = Drawdown (drain) Time (hrs)
 F_s = Infiltration Rate Factor of Safety (see Section 5)

Step 3. Select a ponding depth, planting media thickness (depth), and reservoir layer thickness (depth, optional) such that the total effective storage depth is no greater than the maximum allowable depth calculated in Step 2:

$$d_t = d_p + l_m n_m + l_r n_r \leq d_{max}$$

Where d_t = Total Effective Water Storage Depth (ft)
 d_m = Ponding Depth (ft)
 l_m = Planting Media Thickness Depth (ft)
 n_m = Planting Media Porosity
 l_r = Reservoir Layer Thickness Depth (ft)
 n_r = Reservoir Layer Porosity
 d_{max} = Maximum Storage Depth from Step 2 (ft)

Step 4. Calculate the basin bottom surface area (A_b):

$$A_b = WQV / (d_t + kT / 12F_s)$$

Where A_{BMP} = Bottom Surface Area (sq-ft)
 WQV = WQV from Step 1 (cu-ft)
 d_t = Total Effective Water Storage Depth from Step 3 (ft)
 k = Soil Infiltration Rate (in/hr)
 T = Fill Time (time for the BMP to fill with water [hrs])
 F_s = Infiltration Rate Factor of Safety (see Section 5)

Step 5. Select a basin bottom width (w_b), and calculate the basin bottom length (l_b):

$$A_b = WQV / (d_t + kT / 12F_s)$$

Where l_b = Bottom Length (ft)
 A_b = Bottom Surface Area from Step 4 (sq-ft)
 w_b = Bottom Width (ft)

Step 6. Calculate the total area occupied by the BMP excluding pretreatment (A_{BMP}) using the basin bottom dimensions, embankment side slopes, and freeboard:

$$A_{BMP} = [w_b + 2z(d_p + f)] \times [l_b + 2z(d_p + f)]$$

Where A_{BMP} = Area Occupied by BMP Excluding Pretreatment (sq-ft)
 w_b = Bottom Width from Step 5 (ft)
 z = Basin Interior Side Slope (length per unit height)
 d_b = Design Ponding Depth from Step 3 (ft)
 f = Freeboard (ft)
 l_b = Bottom Length from Step 5 (ft)

If the calculated area does not fit in the available space, either reduce the drainage area, increase the ponding depth or planting soil depth or gravel depth (if the total effective depth is not already equal to the maximum depth), and/or reduce the Infiltration rate factor of safety (if minimum number of test pits and permeability tests have not been performed) and repeat the calculations.

Pretreatment Considerations

Infiltration facilities are highly susceptible to clogging and premature failure from sediment, trash, and other materials. Suitable pretreatment systems maintain the infiltrate rate of the device without frequent and intensive maintenance. For measured soil infiltration rates below 3 in/hr, pretreatment is strongly recommended, and the pretreatment device should be sized for at least 25% of the WQV. For measured soil infiltration rates greater than 3 in/hr, pretreatment is mandatory to minimize groundwater contamination risks, and the pretreatment device must be sized for at least 50% of the WQV if the measured soil infiltration rate is below 5 in/hr and 100% of the WQV if the measured soil infiltration rate is greater than 5 in/hr. Pretreatment may be achieved with vegetated swales, vegetated filter strips, sedimentation basins or forebays, sedimentation manholes, and manufactured treatment devices.

Area Requirements

A bioretention basin requires a footprint equivalent to 4% - 13% of its contributing impervious drainage area, excluding pretreatment. The lower value reflects the maximum allowable infiltration rate and minimum allowable factor of safety, while the upper value reflects the minimum allowable infiltration rate and maximum allowable factor of safety.

Sizing Example

Calculate the size of a bioretention basin serving a 1-acre residential development. Assume the following design parameters:

Design Parameter	Units	Value
Percent Impervious Cover, I	percent	70
Design Storm Depth, P	inches	1.0
Basin Fill Time, T	hours	2
Drawdown (drain) Time, t	hours	48

Design Parameter	Units	Value
Basin Interior Side Slope (length per unit height), z		3
Planting Media Porosity, n_m		0.25
Reservoir Layer Porosity, n_r		0.30
Soil Infiltration Rate, k	inches/hour	1.0
Freeboard, f	feet	1.0
Infiltration Rate Factor of Safety, F_s		2

1. Calculate the volumetric runoff coefficient (C) and WQV:

$$C = 0.05 + 0.009I$$

$$C = 0.05 + 0.009 \times 70$$

$$C = 0.68$$

$$WQV = PCA \times 3630$$

$$WQV = 1 \times 0.68 \times 1 \times 3630$$

$$WQV = 2,468 \text{ cu-ft}$$

2. Calculate the maximum allowable water storage depth in the dry well (d_{\max}):

$$d_{\max} = kt/12F_s$$

$$d_{\max} = 1.0 \times 48/(12 \times 2)$$

$$d_{\max} = 2.0 \text{ ft}$$

3. Select a ponding depth (d_p), planting media depth (l_m), and optional reservoir layer depth (l_r) such that the total effective storage depth (d_t) is no greater than the maximum allowable depth:

$$d_p = 0.67 \text{ ft}$$

$$l_m = 4.0 \text{ ft}$$

$$l_r = 1.0 \text{ ft}$$

$$d_t = d_p + l_m n_m + l_r n_r$$

$$d_t = 0.67 + 4.0 \times 0.25 + 1.0 \times 0.30$$

$$d_t = 1.97 \text{ ft}$$

4. Calculate the basin bottom surface area (A_b):

$$A_b = WQV/(d_t + kT/12F_s)$$

$$A_b = 2,468/[1.97 + 1.0 \times 2.0/(12 \times 2)]$$

$$A_b = 1,204 \text{ sq-ft}$$

5. Set the basin bottom width (w_b) to 25 ft, and calculate the basin bottom length (l_b):

$$\begin{aligned} l_b &= A_b/w_b \\ l_b &= 1,204/25 \\ l_b &= 48.2 \text{ sq-ft} \end{aligned}$$

6. Calculate the total area excluding pretreatment (A_{BMP}):

$$\begin{aligned} A_{\text{BMP}} &= [w_b + 2z(d_p + f)] \times [l_b + 2z(d_p + f)] \\ A_{\text{BMP}} &= [25 + 2 \times 3(0.67 + 1)] \times [48.2 + 2 \times 3(0.67 + 1)] \\ A_{\text{BMP}} &= 2,037 \text{ sq-ft} \end{aligned}$$

Other Design Considerations

- The plantings should emulate a terrestrial forest community ecosystem. Native species should be selected, taking into account the local climate, expected water depth in the basin, and expected tolerances to pollutant loads and varying soil moistures. The trees should be smaller ones similar to those found in the forest understory, since it is more difficult to perform maintenance with the tall trees that are normally part of the forest canopy. Ground cover, such as grasses or legumes, should be planted after the trees and shrubs are in place.
- An overflow device (e.g., domed riser, spillway) must be included to safely convey runoff from large storm events when the surface/subsurface capacity is exceeded.
- If a mulch layer is used on the surface of the planting bed, consideration should be given to problems caused by flotation during storm events.
- Observation wells are recommended. They will indicate how quickly the basin dewateres following a storm and it will provide a method of observing how quickly the basin fills up with sediments.

Construction/Inspection Considerations

Bioretention basins should not be established until contributing watershed is stabilized.

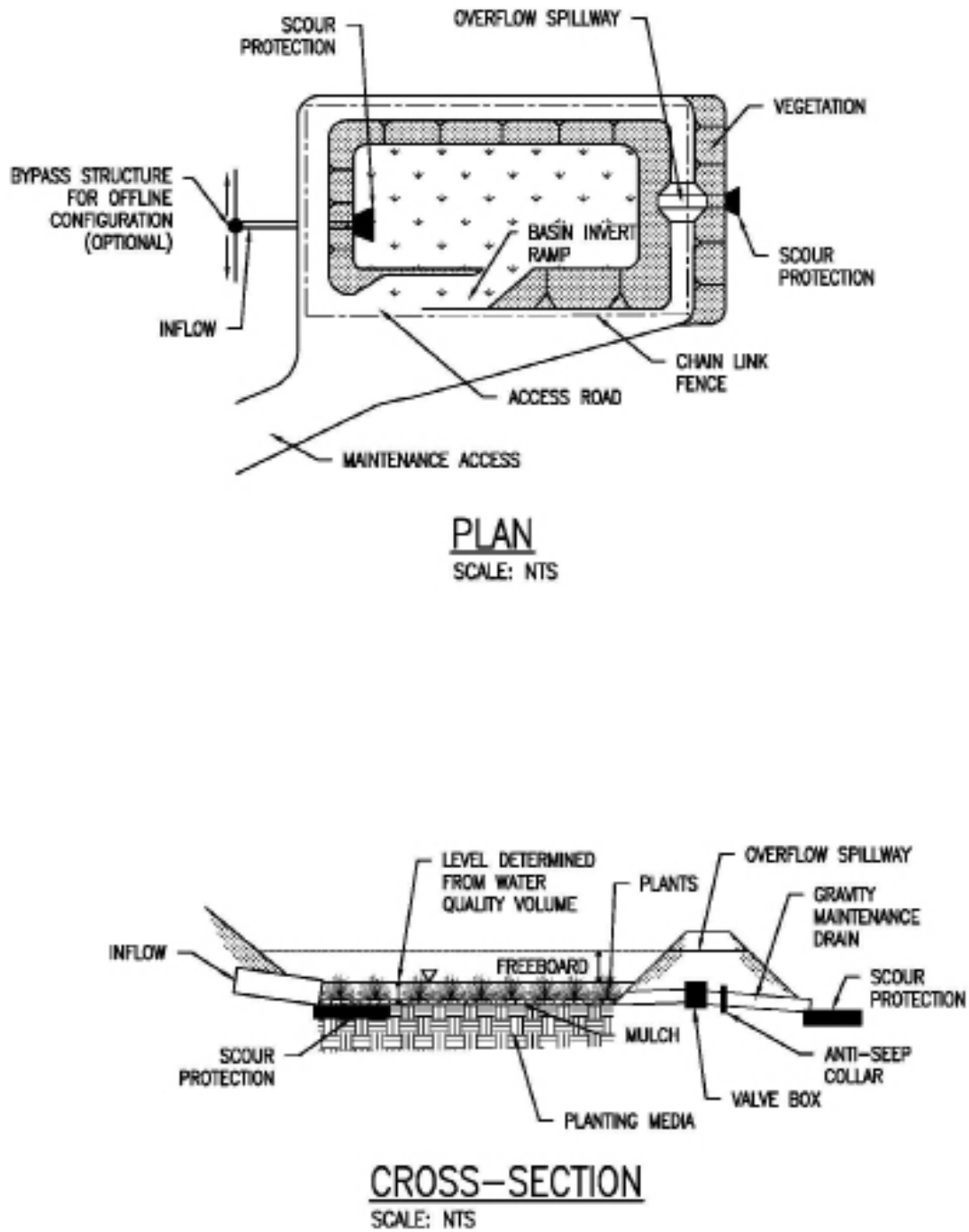

Schematic of a Bioretention Basin

TC-06: Permeable Pavement



UH Hale Halawai Overflow Parking

BMP Category	
Retention	●
Biofiltration	○
Other	○

O&M Requirements
Low

Expected Pollutant Removals			
Nutrients	High	Pesticides	High
Sediment	High	Oil & Grease	High
Trash	High	Metals	High
Pathogens	High	Organic Compounds	High

Description

Sometimes referred to as pervious pavement or porous pavement, permeable pavement refers to any porous, load-bearing surface that allows for temporary rainwater storage in an underlying aggregate layer until it infiltrates into the soil matrix. It includes pervious concrete, porous asphalt, interlocking paver blocks, and reinforced turf and gravel filled grids.

Minimum Design Criteria

Design Parameter	Units	Value
Maximum Depth of Reservoir Layer	feet	3
Drawdown (drain) Time	hours	48
Minimum Depth from Reservoir Invert to Groundwater Table	feet	3
Minimum Soil Infiltration Rate	inches/hour	0.5

Feasibility Criteria

See Section 5.5: Feasibility Criteria.

Sizing Procedure

- Step 1. Use the procedure presented previously to compute the Volumetric Runoff Coefficient and WQV.

Step 2. Calculate the maximum allowable water storage depth (d_{max}) using the underlying soil infiltration rate (k) and the required drawdown time (t):

$$d_{max} = kt / (F_s \times 12)$$

Where d_{max} = Maximum Storage Depth (ft)
 k = Soil Infiltration Rate (in/hr)
 t = Drawdown (drain) Time (hrs)
 F_s = Infiltration Rate Factor of Safety (see Section 5)

Step 3. Select a pavement course thickness (l_p) and reservoir course thickness (l_r) such that the total effective storage depth (d_t) is no greater than the maximum allowable depth:

$$d_t = (l_p n_p + l_r n_r) / 12 \leq d_{max}$$

Where d_t = Total Effective Water Storage Depth (ft)
 l_p = Pavement Course Thickness (in)
 n_p = Pavement Course Porosity
 l_r = Reservoir Layer Thickness Depth (in)
 n_r = Reservoir Layer Porosity
 d_{max} = Maximum Storage Depth from Step 2 (ft)

Step 4. Calculate the BMP surface area (A_{BMP}):

$$A_{BMP} = WQV / (d_t + kT / 12F_s)$$

Where A_{BMP} = BMP Surface Area (sq-ft)
 WQV = WQV from Step 1 (cu-ft)
 d_t = Total Effective Water Storage Depth from Step 3 (ft)
 k = Soil Infiltration Rate (in/hr)
 T = Fill Time (time for the BMP to fill with water [hrs])
 F_s = Infiltration Rate Factor of Safety (see Section 5)

If the calculated area does not fit in the available space, either reduce the drainage area, increase the pavement course depth or reservoir course depth or gravel depth (if the total effective depth is not already equal to the maximum depth), and/or reduce the Infiltration rate factor of safety (if minimum number of test pits and permeability tests have not been performed) and repeat the calculations.

Pretreatment Considerations

Pretreatment is not required as long as the permeable pavement does not receive run-on from other surfaces. If it does, pretreatment is necessary to prevent premature failure due to clogging with fine sediment, and may be achieved with gravel filter strips, vegetated buffer strips, or vegetated swales.

Area Requirements

Permeable pavement requires a footprint equivalent to 5% - 18% of its contributing impervious drainage area. The lower value reflects the maximum allowable infiltration rate and minimum allowable factor of safety, while the upper value reflects the minimum allowable infiltration rate and maximum allowable factor of safety.

Sizing Example

Calculate the size of a section of permeable pavement serving the runoff from a 1-acre parking lot. Assume the following design parameters:

Design Parameter	Units	Value
Percent Impervious Cover, I	percent	100
Design Storm Depth, P	inches	1.0
Reservoir Layer Time, T	hours	2
Drawdown (drain) Time, t	hours	48
Pavement Course Porosity, n_p		0.15
Reservoir Course Porosity, n_r		0.35
Soil Infiltration Rate, k	inches/hour	1.0
Infiltration Rate Factor of Safety, F_s		2

1. Calculate the volumetric runoff coefficient (C) and WQV:

$$C = 0.05 + 0.009I$$

$$C = 0.05 + 0.009 \times 100$$

$$C = 0.95$$

$$WQV = PCA \times 3630$$

$$WQV = 1 \times 0.95 \times 1 \times 3630$$

$$WQV = 3,449 \text{ cu-ft}$$

2. Calculate the maximum allowable water storage depth in the dry well (d_{\max}):

$$d_{\max} = kT/12F_s$$

$$d_{\max} = 1.0 \times 48/(12 \times 2)$$

$$d_{\max} = 2.0 \text{ ft}$$

3. Select a pavement course thickness (l_p) and reservoir course thickness (l_r) such that the total effective storage depth (d_t) is no greater than the maximum allowable depth:

$$l_p = 12.0 \text{ ft}$$

$$l_r = 24.0 \text{ ft}$$

$$d_t = (l_p n_p + l_r n_r)/12$$

$$d_t = (12 \times 0.15 + 24.0 \times 0.35)/12$$

$$d_t = 0.85 \text{ ft}$$

4. Calculate the pavement surface area:

$$A_{IMP} = WQV/[d_t + (kT/12F_s)]$$

$$A_{IMP} = 3,449/[0.85 + (1.0 \times 2.0/(12 \times 2))]$$

$$A_{IMP} = 3,695 \text{ sq-ft}$$

Other Design Considerations

- All porous paving and permeable paver with storage bed systems must include measures that will allow runoff from the design storm to enter the storage bed in the event that the porous or permeable paver surface course becomes clogged or otherwise incapable of conveying the maximum design storm runoff to the bed.
- Additional design details on specific pavement systems are provided by the National Asphalt Pavement Association, the National Ready Mix Concrete Association, the Interlocking Concrete Pavement Institute, and the American Association of State Highway and Transportation Officials.
- Perforated pipes along the bottom of the bed may be used to evenly distribute runoff over the entire bed bottom. Pipes should lay flat along the bed bottom and provide for uniform distribution of water. Depending on size, these pipes may provide additional storage volume.
- Flows in excess of the design capacity of the permeable pavement system will require an overflow system connected to a downstream conveyance or other storm water runoff BMP.

Construction/Inspection Considerations

- Permeable surfaces can be laid without cross-falls or longitudinal gradients.
- The blocks should be laid level.
- They should not be used for storage of site materials, unless the surface is well protected from deposition of silt and other spillages.
- The pavement should be constructed in a single operation, as one of the last items to be built, on a development site. Landscape development should be completed before pavement construction to avoid contamination by silt or soil from this source.
- Surfaces draining to the pavement should be stabilized before construction of the pavement.
- Inappropriate construction equipment should be kept away from the pavement to prevent damage to the surface, sub-base or sub-grade.

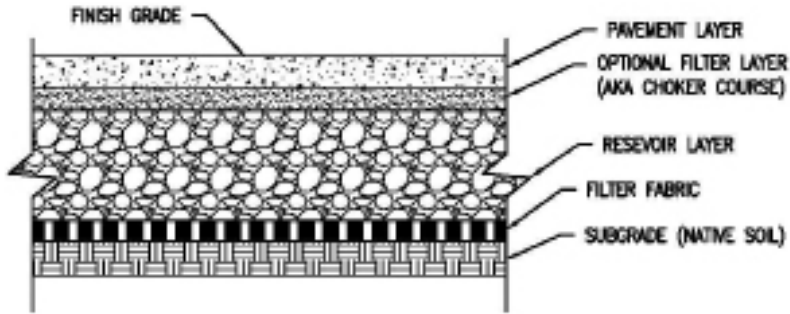

TYPICAL SECTION— PERVIOUS CONCRETE OR
POROUS ASPHALT
SCALE: NTS

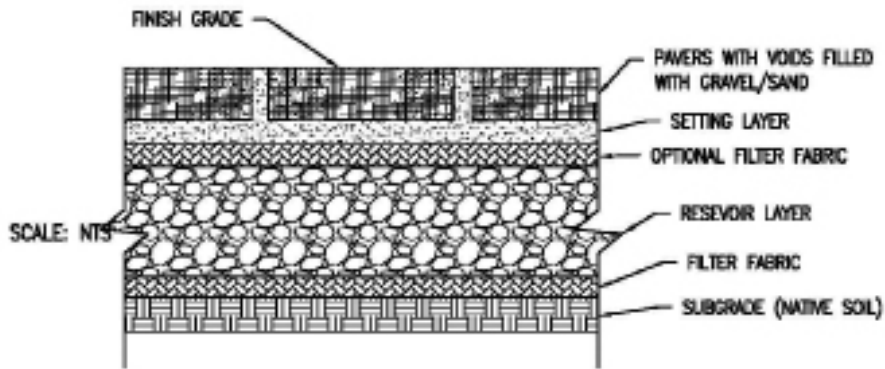

TYPICAL SECTION – PERMEABLE PAVERS

Schematic of a Permeable Pavement

This page is intentionally left blank.

TC-07: Green Roof



University of Hawaii C-MORE Hale (hahana.soest.hawaii.edu)

BMP Category	
Retention	<input type="radio"/>
Biofiltration	<input checked="" type="radio"/>
Other	<input type="radio"/>

O&M Requirements
Medium

Expected Pollutant Removals			
Nutrients	Medium	Pesticides	Medium
Sediment	High	Oil & Grease	High
Trash	High	Metals	Medium
Pathogens	Medium	Organic Compounds	Medium

Description

Sometimes referred to as a vegetated roof or eco-roof, a green roof is a roof that is entirely or partially covered with vegetation and soils for the purpose of filtering, absorbing, evapotranspiring, and retaining/detaining the rain that falls upon it.

Minimum Design Criteria

Design Parameter	Units	Value
Minimum Depth of Soil Media	inches	2
Minimum Depth of Drainage Layer	inches	2
Maximum Slope on Roof	percent	20

Feasibility Criteria

See Section 5.5: Feasibility Criteria.

Sizing Procedure

- Step 1. Use the procedure presented previously to compute the Volumetric Runoff Coefficient and WQV.
- Step 2. Select initial values for the soil media thickness (l_m), drainage layer thickness (l_d), and allowable ponding depth (d_p).

Step 3. Calculate the total effective storage depth based on instantaneous storage capacity using the void space in the soil media and drainage layer, and the allowable ponding:

$$d_t = (d_p + l_m n_m + l_d n_d) / 12$$

Where d_t = Total Effective Water Storage Depth (ft)
 d_p = Ponding Depth (in)
 l_m = Planting Media Thickness Depth (in)
 n_m = Planting Media Porosity
 l_d = Drainage Layer Thickness (in)
 n_d = Drainage Layer Porosity

Step 4. Calculate area required (A_{BMP}) based on the instantaneous storage capacity:

$$A_{BMP} = WQV / d_t$$

Where A_{BMP} = BMP Area (sq-ft)
 WQV = WQV from Step 1 (cu-ft)
 d_t = Total Effective Water Storage Depth from Step 3 (ft)

If the calculated area does not fit in the available space, either reduce the tributary area and/or increase one or more of the design depths (ponding, soil media, drainage layer), and repeat the calculations.

Pretreatment Considerations

Green roofs do not require pretreatment.

Area Requirements

A green roof requires a footprint equivalent to 11% - 100% of the contributing roof drainage area. The lower value corresponds to 4 inches of ponding and maximum depths for both the planting media and drainage layer depths, while the higher value corresponds to no ponding and minimum planting media and drainage layer depths.

Sizing Example

Calculate the size of a green roof serving the roof runoff from a 1,500 sq-ft fast food restaurant. Assume the following design parameters:

Design Parameter	Units	Value
Percent Impervious Cover, I	percent	100
Design Storm Depth, P	inches	1.0
Soil Media Porosity, n_m		0.20
Drainage Layer Porosity, n_d		0.25

1. Calculate the volumetric runoff coefficient (C) and WQV:

$$C = 0.05 + 0.009I$$

$$C = 0.05 + 0.009 \times 100$$

$$C = 0.95$$

$$WQV = PCA \times 3,630$$

$$WQV = 1 \times 0.95 \times (1,500/43,560) \times 3,630$$

$$WQV = 119 \text{ cu-ft}$$

2. Select initial values for the soil media depth (d_m), drainage layer depth (d_d), and ponding depth (d_p):

$$d_m = 3 \text{ in}$$

$$d_d = 2 \text{ in}$$

$$d_p = 0.5 \text{ in}$$

3. Calculate the total effective storage depth:

$$d_t = (d_p + 1_m n_m + 1_d n_d)/12$$

$$d_t = (0.5 + 3 \times 0.20 + 2 \times 0.25)/12$$

$$d_t = 0.133 \text{ ft}$$

4. Calculate the area (A_{BMP}):

$$A_{BMP} = WQV/d_t$$

$$A_{BMP} = 119/0.133$$

$$A_{BMP} = 891 \text{ sq-ft}$$

891 sq-ft is available, so the design is okay.

Other Design Considerations

- Safety measures against wind uplift must be taken into account during design, especially for areas susceptible to high winds during the summer trade-wind period.
- The maximum load bearing capacity of the roof construction must be considered when installing vegetated roofs. The water saturated weight of the green roof system, including vegetation must be calculated as permanent load. Generally, vegetated roofs weigh between 15 and 30 lb/sq-ft depending on the thickness of the vegetated roof system. In addition, construction elements such as pergolas and walkways cause high point loads and, therefore, have to be calculated accordingly.
- The design must include adequate roof access for delivery of construction materials and for routine maintenance.
- The drainage layer below the growth media should be designed to convey the flood design storm without backing water up to into the growing media. The drainage layer should convey flow to an outlet or overflow system such as a traditional rooftop drainage system with inlets set slightly above the elevation of the vegetated roof surface.

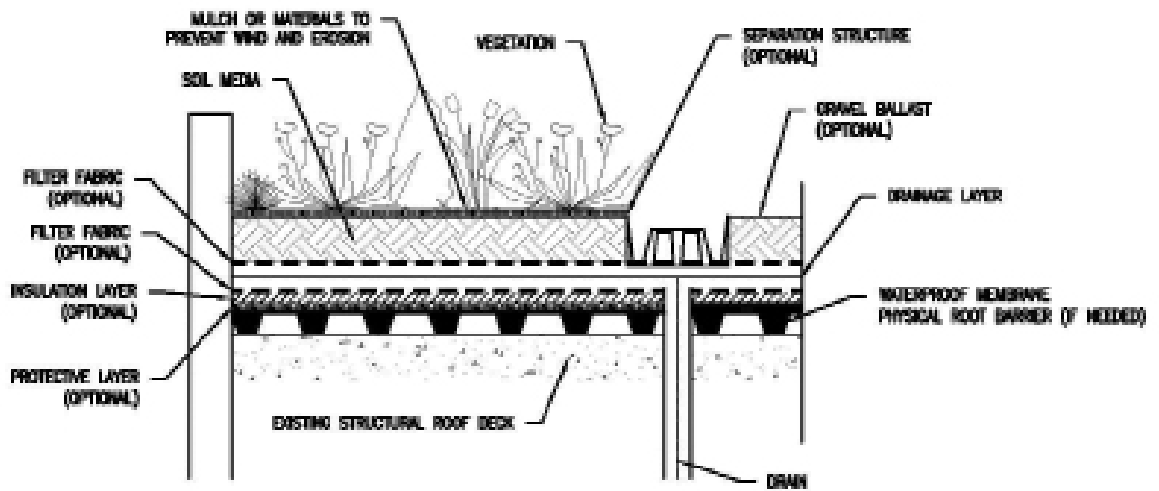

TYPICAL SECTION
SCALE: NTS

Schematic of a Green Roof

TC-08: Vegetated Bio-Filter



Waikiki

BMP Category	
Retention	<input type="radio"/>
Biofiltration	<input checked="" type="radio"/>
Other	<input type="radio"/>

O&M Requirements
Low

Expected Pollutant Removals			
Nutrients	Medium	Pesticides	Unknown
Sediment	High	Oil & Grease	High
Trash	High	Metals	High
Pathogens	Medium	Organic Compounds	High

Description

This category of BMPs may also be referred to as a bioretention filter, storm water curb extension, tree box filter, or planter box. A vegetated bio-filter is an engineered shallow depression or above ground system that collects and filters storm water runoff using conditioned planting soil beds and vegetation. The filtered runoff discharges through an underdrain system.

Minimum Design Criteria

Design Parameter	Units	Value
Planting Soil Coefficient of Permeability	feet/day	1.0
Mulch Thickness	inches	2 – 4
Planting Soil Depth	feet	2 – 4
Drawdown (drain) Time	hours	48
Maximum Ponding Depth	inches	12
Minimum Underdrain Diameter	inches	6

For proprietary systems, follow the manufacturer's guidelines for appropriate sizing calculations and selection of appropriate device/model.

Feasibility Criteria

See Section 5.5: Feasibility Criteria.

Sizing Procedure

- Step 1. Use the procedure presented previously to compute the Volumetric Runoff Coefficient and WQV.

Step 2. Select initial values for the soil media thickness (l_m), drainage layer thickness (l_d), and allowable ponding depth (d_p).

Step 3. Use Darcy's Law to calculate the required Filter Bed Surface Area:

$$A_b = (WQV \times l_m) / k (l_m + d_p / 24) (t / 24)$$

Where A_b = Filter Bed Surface Area (sq-ft)
 WQV = WQV from Step 1 (cu-ft)
 l_m = Planting Media Depth from Step 2 (ft)
 k = Planting Media Permeability Coefficient (ft/day)
 d_p = Maximum Ponding Depth from Step 2 (in)
 t = Filter Bed Drain Time (hr)

Step 4. Select a filter bed width (w_b), and calculate the filter bed length (l_b):

$$l_b = A_b / w_b$$

Where l_b = Filter Bed Length (ft)
 A_b = Filter Bed Surface Area from Step 3 (sq-ft)
 w_b = Filter Bed Width (ft)

Step 5. Calculate the total area occupied by the BMP excluding pretreatment (A_{BMP}) using the filter bed dimensions, embankment side slopes, and freeboard:

$$A_{BMP} = [w_b + 2z(d_p + f)] \times [l_b + 2z(d_p + f)]$$

Where A_{BMP} = Area occupied by BMP excluding Pretreatment (sq-ft)
 w_b = Filter Bed Width from Step 4
 z = Filter Bed Interior Slope (length per unit height)
 d_p = Maximum Ponding Depth from Step 2 (ft)
 f = Freeboard (ft)
 l_b = Filter Bed Length from Step 4 (ft)

If the calculated area does not fit in the available space, either reduce the drainage area, reduce the planting soil depth (if it's not already set to the minimum), and/or increase the ponding depth (if it's not already set to the maximum depth), and repeat the calculations.

Pretreatment Considerations

Pretreatment should be provided where sediments or trash may cause a concern or decreased BMP functionality, and when space permits. Pretreatment may be achieved with vegetated swales, vegetated buffer strips with pea gravel or stone diaphragm, or manufactured treatment device.

Area Requirements

A vegetated bio-filter requires a footprint equivalent to 3.3% - 3.8% of its contributing impervious drainage area, excluding pretreatment. The lower value reflects the minimum planting media depth and maximum ponding depth, while the upper value reflects the maximum planting media depth and minimum ponding depth.

Sizing Example

Calculate the size of a vegetated bio-filter serving a 1-acre residential development. Assume the following design parameters:

Design Parameter	Units	Value
Percent Impervious Cover, I	percent	70
Design Storm Depth, P	inches	1.0
Planting Soil Coefficient of Permeability, k	feet/day	1.0
Drawdown (drain) Time, t	hours	48
Interior Side Slope (length per unit height), z		0
Freeboard, f	feet	0.5

1. Calculate the volumetric runoff coefficient (C) and WQV:

$$C = 0.05 + 0.009I$$

$$C = 0.05 + 0.0039 \times 70$$

$$C = 0.68$$

$$WQV = PCA \times 3,630$$

$$WQV = 1 \times 0.68 \times 1 \times 3,630$$

$$WQV = 2,468 \text{ cu-ft}$$

2. Select a planting soil depth (d_s) and ponding depth (d_p):

$$d_s = 2 \text{ ft}$$

$$d_p = 6 \text{ in}$$

3. Calculate the Filter Bed Surface Area (A_{BMP}):

$$A_{BMP} = WQV \times d_s / [k(d_s + (d_p/24))(t/24)]$$

$$A_{BMP} = 2,468 \times 2 / [1(2 + (6/24))(48/24)]$$

$$A_{BMP} = 1,097 \text{ sq-ft}$$

4. Set the bottom width (w_b) to 6 ft, and calculate the bottom length (l_b):

$$l_b = A_b / w_b$$

$$l_b = 1,097 / 6$$

$$l_b = 182.8 \text{ ft}$$

5. Calculate the total area excluding pretreatment (A_{BMP}):

$$A_{BMP} = [w_b + 2z(d_p + f)] \times [l_b + 2z(d_p + f)]$$

$$A_{BMP} = [6 + 2 \times 0 \times (0.5 + 0.5)] \times [182.8 + 2 \times 0 \times (0.5 + 0.5)]$$

$$A_{BMP} = 1,097 \text{ sq-ft}$$

Other Design Considerations

- All bio-filters must be able to safely overflow or bypass flows in excess of the storm water quality design storm to downstream drainage systems when the surface/subsurface capacity is exceeded.
- If a mulch layer is used on the surface of the planting bed, consideration should be given to problems caused by flotation during storm events.
- A cleanout pipe should be tied into the end of all underdrain pipe runs.

Construction/Inspection Considerations

Vegetated biofilters should not be established until contributing watershed is stabilized.

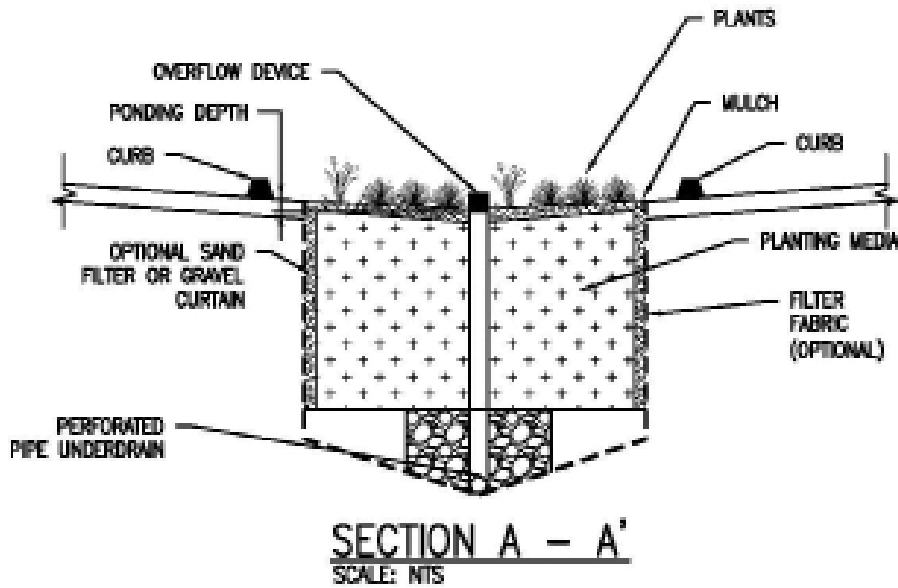
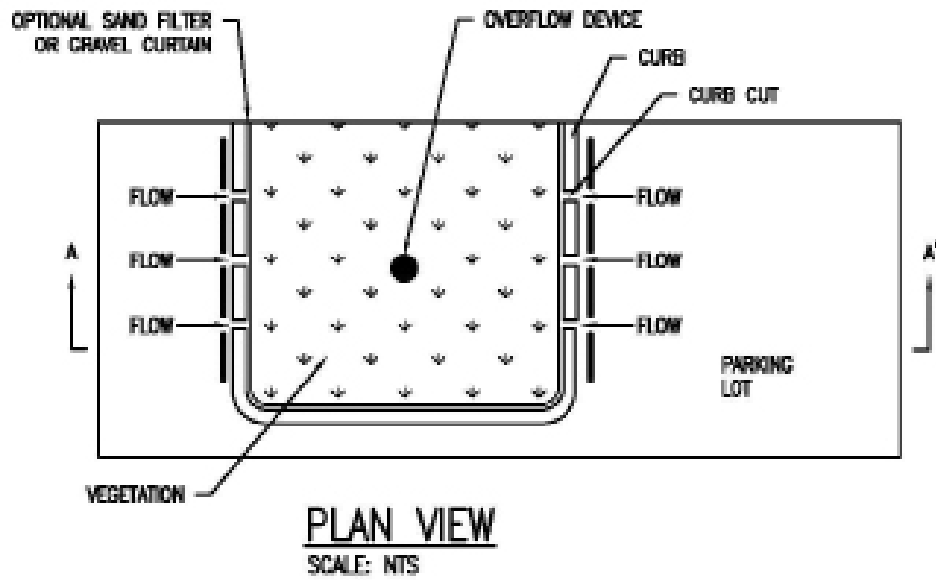

Schematic of a Vegetated Bio-Filter

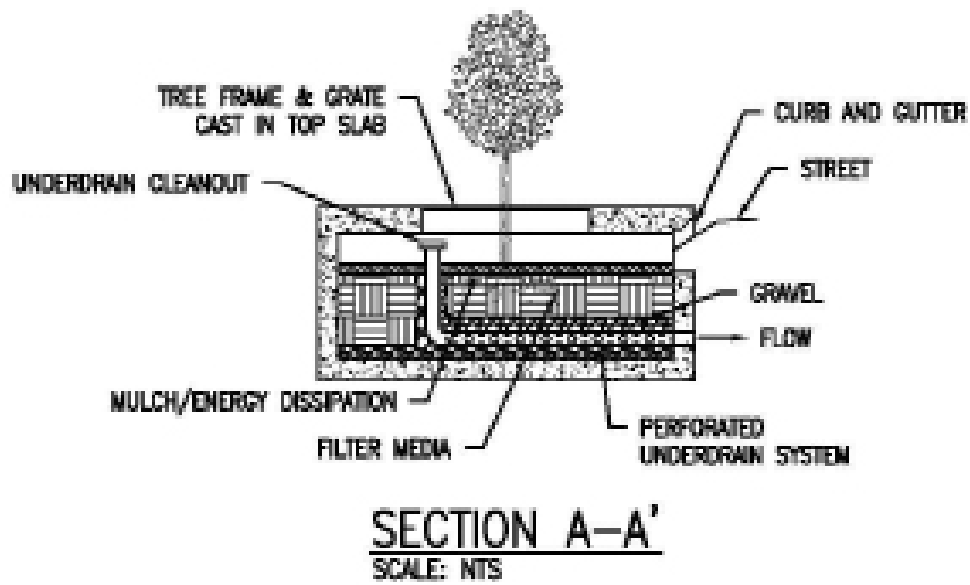
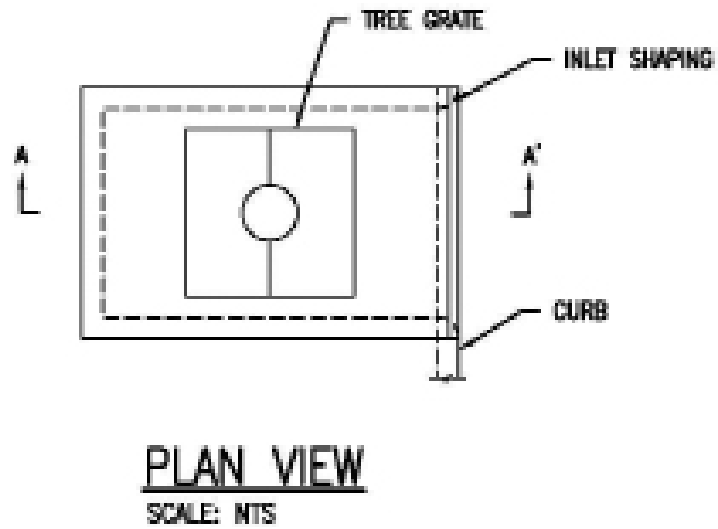

Schematic of a Tree Box Filter

TC-09: Enhanced Swale



Georgia Stormwater Management Manual, 2001.

BMP Category	
Retention	<input type="radio"/>
Biofiltration	<input checked="" type="radio"/>
Other	<input type="radio"/>

O&M Requirements
Medium

Expected Pollutant Removals			
Nutrients	Medium	Pesticides	Unknown
Sediment	High	Oil & Grease	Medium
Trash	High	Metals	Medium
Pathogens	Unknown	Organic Compounds	Unknown

Description

Sometimes referred to as a bioretention swale or dry swale, an enhanced swale is a shallow linear channel with a planting bed and covered with turf or other surface material (other than mulch or plants). Runoff filters through a planting bed, is collected in an underdrain system, and discharged at the downstream end of the swale.

Minimum Design Criteria

Design Parameter	Units	Value
Maximum Interior Side Slope (length per unit height)		3:1
Bottom width	feet	2 - 8
Maximum Longitudinal Slope without check dams	percent	2
Maximum Longitudinal Slope with check dams	percent	5
Maximum check dam height	inches	12
Maximum Ponding Depth at downstream end	inches	18
Media depth	inches	18 - 36
Minimum Freeboard	feet	0.5
Minimum Underdrain Diameter	inches	6

Feasibility Criteria

See Section 5.5: Feasibility Criteria.

Sizing Procedure

- Step 1. Use the procedure presented previously to compute the Volumetric Runoff Coefficient and WQV.

Step 2. Select values for the planting media thickness, drainage layer thickness, planting media porosity, drainage layer porosity, maximum surface ponding depth (if check dams are used), bottom width, and interior side slope (length per unit height).

Step 3. Calculate the total effective storage depth based on the instantaneous storage capacity using the void space in the planting media and drainage layer, and the average ponding depth (assumed to be one-half the maximum ponding depth):

$$d_t = [(d_p/2) + l_m n_m + l_d n_d]/12$$

Where d_t = Total Effective Water Storage Depth (ft)
 d_p = Maximum Ponding Depth from Step 2 (in)
 l_m = Planting Media Thickness from Step 2 (in)
 n_m = Planting Media Porosity, typically around 0.25
 l_d = Drainage Layer Thickness from Step 2 (in)
 n_d = Drainage Layer Porosity, typically around 0.40

Step 4. Calculate the swale invert area required (A_b) based on the instantaneous storage capacity (neglecting the additional ponding capacity due to the shape of the swale sides):

$$A_b = WQV/d_t$$

Where A_b = Bottom Surface Area (sq-ft)
 WQV = WQV from Step 1 (cu-ft)
 d_t = Total Effective Water Storage Depth from Step 3 (cu-ft)

Step 5. Calculate the total area required (A_{BMP}) taking into account the side slopes along the length of the swale:

$$A_{BMP} = [b + 2z(f + d_p/12)] \times (A_b/b)$$

Where A_{BMP} = Total Surface Area (sq-ft)
 b = Swale Bottom Width from Step 2 (ft)
 z = Interior Swale Side Slope (length per unit height) from Step 2
 d_p = Ponding Depth from Step 2 (in)
 f = Freeboard (ft)
 A_b = Bottom Surface Area from Step 4 (sq-ft)

If the minimum surface area is larger than the available space, reduce the tributary area and/or increase one or more design depths (media, gravel, ponding), and repeat the calculations.

Pretreatment Considerations

Pretreatment for enhanced swales is provided by a shallow sediment forebay at the initial point of the channel. The volume of this forebay should be equal to at least 0.05 in. per impervious acre of drainage.

A pea gravel diaphragm can be used along the top of the channel to provide pretreatment for lateral flows entering the swale.

Area Requirements

An enhanced swale requires a footprint equivalent to 8% - 40% of its contributing impervious drainage area. The lower value corresponds to the maximum allowable values for the mentioned dependent variables, while the upper value reflects the minimum allowable values for all specified parameters.

Sizing Example

Calculate the size of an enhanced swale serving a 1-acre residential development. Assume the following design parameters:

Design Parameter	Units	Value
Percent Impervious Cover, I	percent	70
Design Storm Depth, P	inches	1.0
Media porosity, n_m		0.25
Drainage layer porosity, n_d		0.40
Freeboard, f	feet	0.5
Drawdown (drain) Time, t	hours	48

1. Calculate the volumetric runoff coefficient (C) and WQV:

$$C = 0.05 + 0.009I$$

$$C = 0.05 + 0.0039 \times 70$$

$$C = 0.68$$

$$WQV = PCA \times 3,630$$

$$WQV = 1 \times 0.68 \times 1 \times 3,630$$

$$WQV = 2,468 \text{ cu-ft}$$

2. Select a media thickness (l_m), drainage layer thickness (l_d), ponding depth (d_p), bottom width (b), and interior side slope (z):

$$l_m = 18 \text{ in}$$

$$l_d = 6 \text{ in}$$

$$d_p = 12 \text{ in}$$

$$b = 8 \text{ ft}$$

$$z = 3$$

3. Calculate the total effective storage depth:

$$d_t = [(d_p/2) + l_m n_m + l_d n_d]/12$$

$$d_t = (6 + 18 + 0.25 + 6 \times 0.40)/12$$

$$d_t = 1,075 \text{ sq-ft}$$

4. Calculate the minimum invert area (A_b) needed for the WQV and depths:

$$\begin{aligned}A_b &= WQV/d_t \\A_b &= 2,468/1.075 \\A_b &= 2,296 \text{ sq-ft}\end{aligned}$$

5. Calculate the total area required (A_{BMP}):

$$\begin{aligned}A_{BMP} &= [b + 2z(f + d_p/12)] \times (A_b/b) \\A_{BMP} &= [8 + 2 \times 3 \times (0.5 + 12/12)] \times (2,296/8) \\A_{BMP} &= 4,879 \text{ sq-ft}\end{aligned}$$

Other Design Considerations

- Landscape design should specify proper grass species based on specific site, soils and hydric conditions present along the channel. Vegetation should be designed for regular mowing, like a typical lawn, or less frequently (annually or semi-annually).
- Enhanced swales must be adequately designed to safely pass flows that exceed the design storm flows.

Construction/Inspection Considerations

- Include directions in the specifications for use of appropriate fertilizer and soil amendments based on soil properties determined through testing and compared to the needs of the vegetation requirements.
- Install swales at the time of the year when there is a reasonable chance of successful establishment without irrigation; however, it is recognized that rainfall in a given year may not be sufficient and temporary irrigation may be used.
- If sod tiles must be used, they should be placed so that there are no gaps between the tiles; stagger the ends of the tiles to prevent the formation of channels along the swale or strip.
- Use a roller on the sod to ensure that no air pockets form between the sod and the soil.
- Where seeds are used, erosion controls will be necessary to protect seeds for at least 75 days after the first rainfall of the season.

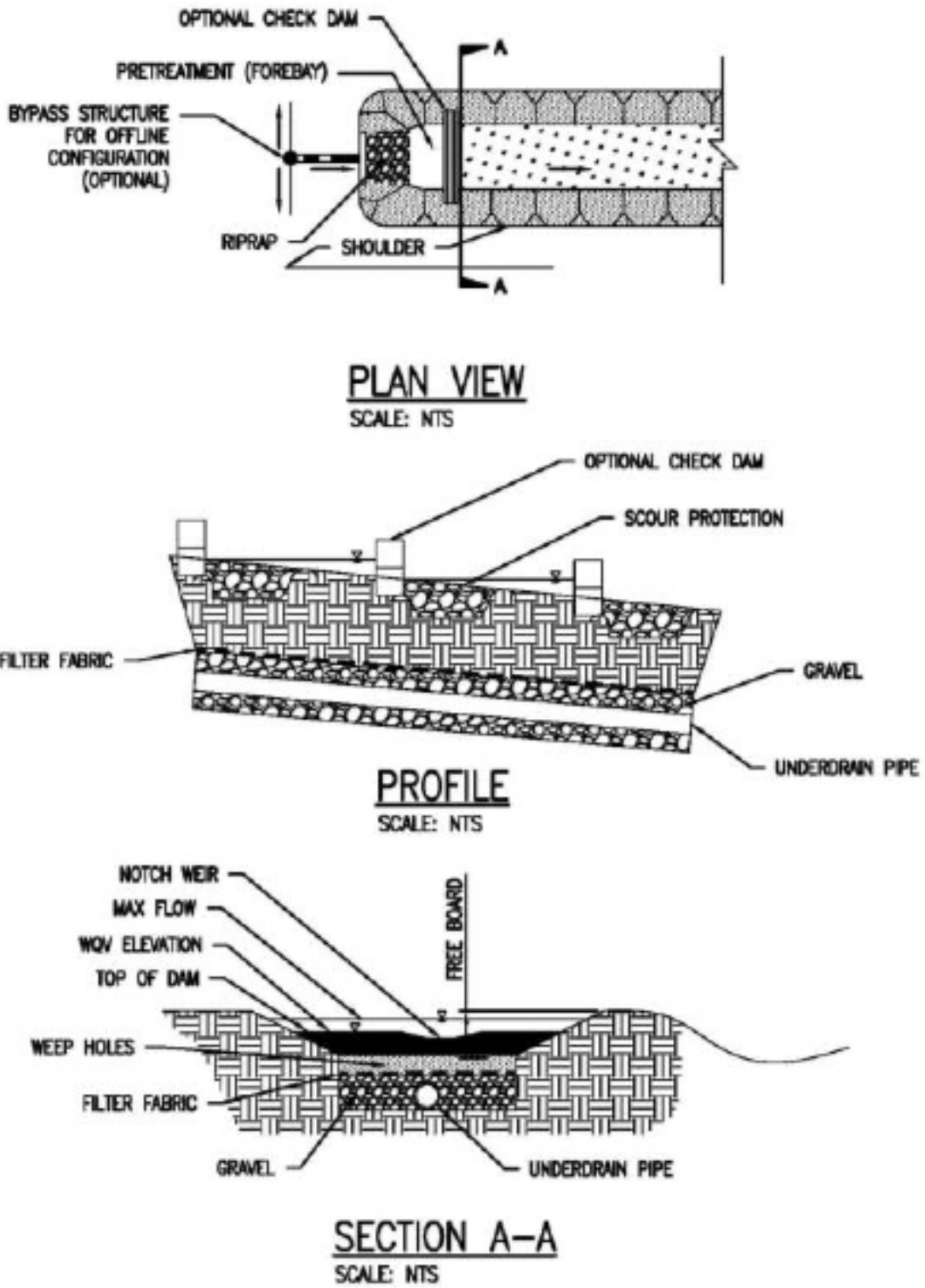

Schematic of an Enhanced Swale

This page is intentionally left blank.

TC-10: Vegetated Swale



Kauai Federal Credit Union (courtesy of Group 70)

BMP Category	
Retention	<input type="radio"/>
Biofiltration	<input checked="" type="radio"/>
Other	<input type="radio"/>

O&M Requirements
Low

Expected Pollutant Removals			
Nutrients	Low	Pesticides	Unknown
Sediment	Medium	Oil & Grease	Medium
Trash	Low	Metals	Medium
Pathogens	Low	Organic Compounds	Unknown

Description

Sometimes referred to as a grass swale, grass channel, or biofiltration swale, a vegetated swale is a broad shallow earthen channel vegetated with erosion resistant and flood tolerant grasses. Runoff typically enters the swale at one end and exits at the other end.

Minimum Design Criteria

Design Parameter	Units	Value
Maximum Interior Side Slope (length per unit height)		3:1
Maximum Flow Velocity	feet/second	1
Maximum Water Depth	inches	4
Minimum Hydraulic Residence Time	minutes	7
Maximum Bottom Width	feet	10
Minimum Freeboard	feet	0.5

Feasibility Criteria

See Section 5.5: Feasibility Criteria.

Sizing Procedure

- Step 1. Use the procedure presented previously to compute the WQF Rate.
- Step 2. Select initial values for swale bottom width (b), depth of flow (y), swale side slope (z), swale longitudinal slope (s), and hydraulic residence time (T).

Step 3. Calculate the cross-sectional area (A), wetted perimeter (WP), and hydraulic radius (R) using the dimensions established in Step 2:

$$A = (by/12) + (zy^2/144)$$

$$WP = b (2y/12)\sqrt{(1+z^2)}$$

$$R = A/WP$$

Where	A	=	Cross Sectional Area (sq-ft)
	WP	=	Wetter Perimeter (ft)
	R	=	Hydraulic Radius (ft)
	b	=	Swale Bottom Width from Step 2 (ft)
	y	=	Depth of Flow for WQV from Step 2 (in)
	z	=	Swale Side Slope (length per unit height) from Step 2

Step 4. Calculate the design flow rate in the swale using the selected dimensions and Manning's Equation:

$$Q = (1.49AR^{2/3}s^{1/2})/n$$

Where	Q	=	Design Flow Rate (cu-ft/sec)
	A	=	Cross Sectional Area from Step 3 (sq-ft)
	R	=	Hydraulic Radius from Step 3 (ft)
	s	=	Longitudinal Slope from Step 2 (percent)
	n	=	Manning's n value

Unless another value can be justified, use a Manning's n value of 0.20 for water quality calculations (lower values, such as 0.035, are only applicable for flood control calculations). If the calculated flow rate is not equal to or greater than the WQF from Step 1, decrease the tributary area and/or increase one or more swale dimensions (bottom width, depth of flow, side slope, or longitudinal slope) and repeat the calculations.

Step 5. Once an appropriate design flow rate is achieved, calculate the design flow velocity using the flow continuity equation:

$$V = Q/A$$

Where	V	=	Design Flow Velocity (ft/sec)
	Q	=	Design Flow Rate from Step 4 (cu-ft/sec)
	A	=	Cross Sectional Area from Step 3 (sq-ft)

If the design flow velocity is greater than the maximum allowed velocity, either include check dams with vertical drops of no more than 12 inches, or revise one or more swale dimensions and repeat the calculations.

Step 6. Multiply the velocity by the hydraulic residence time to determine the length:

$$L = 60VT$$

Where L = Swale Length (ft)
 T = Hydraulic Residence Time from Step 2 (min)
 V = Design Flow Velocity from Step 5 (ft/sec)

Step 7. Calculate the total area required (A_{BMP}) taking into account the side slopes along the length of the swale and the freeboard:

$$A_{BMP} = [b + 2z(f + y/12)] \times L$$

Where A_{BMP} = Total Surface Area (sq-ft)
 b = Swale Bottom Width from Step 2 (ft)
 z = Interior Swale Side Slope (length per unit height) from Step 2
 y = Depth of Flow from WQV from Step 2 (in)
 f = Freeboard (ft)
 L = Swale Length from Step 6 (ft)

If the calculated area does not fit in the available area, reduce the drainage area, reduce the hydraulic residence time (if it is longer than the minimum), and/or revise one or more swale dimensions, and repeat the calculations.

Pretreatment Considerations

Vegetated swales do not require pretreatment.

Area Requirements

A vegetated swale requires a footprint equivalent to 2% - 4% of its contributing impervious drainage area. The lower value corresponds to maximizing the flow depth and slope, while the upper value corresponds to maximizing the bottom width and slope.

Sizing Example

Calculate the size of a grass swale serving the runoff from a one acre parking lot. Assume the following design parameters:

Design Parameter	Units	Value
Weighted Runoff Coefficient, C		0.95
Rainfall Intensity, i	inches/hour	0.4
Interior Side Slope (length per unit height)		3
Manning's n value	-	0.20
Longitudinal Slope, s		0.016
Hydraulic Residence Time, T	minutes	7
Freeboard, f	feet	0.5

1. Calculate the WQF Rate:

$$\begin{aligned} \text{WQF} &= C_i A \\ \text{WQF} &= 0.95 \times 0.4 \times 1.0 \\ \text{WQF} &= 0.38 \text{ cu-ft/sec} \end{aligned}$$

2. Select initial values for swale bottom width (b), depth of flow (y), swale side slope length per unit height (z), swale longitudinal slope (s), and hydraulic residence time (T):

$$\begin{aligned} b &= 2.75 \text{ ft} \\ y &= 3.5 \text{ in} \\ z &= 3 \text{ in} \\ s &= 0.017 \\ T &= 7 \text{ mins} \end{aligned}$$

3. Calculate the cross-sectional area (A), wetted perimeter (WP), and hydraulic radius (R):

$$\begin{aligned} A &= (by/12) + (zy^2/144) \\ A &= (2.75 \times 3.5/12) + (3 \times 3.5^2/144) \\ A &= 1.06 \text{ sq-ft} \end{aligned}$$

$$\begin{aligned} \text{WP} &= b + (2y/12)\sqrt{1+z^2} \\ \text{WP} &= 2.75 + (2 \times 3.5/12)\sqrt{1+3^2} \\ \text{WP} &= 4.59 \text{ ft} \end{aligned}$$

$$\begin{aligned} R &= A/\text{WP} \\ R &= 1.06/4.59 \\ R &= 0.23 \text{ ft} \end{aligned}$$

4. Calculate the design flow rate (Q):

$$\begin{aligned} Q &= 1.49 AR^{2/3} s^{1/2} / n \\ Q &= 1.49 \times 1.06 \times 0.23^{2/3} \times 0.017^{1/2} / 0.20 \\ Q &= 0.39 \text{ cu-ft/sec } (\geq \text{WQF, OK}) \end{aligned}$$

5. Calculate the velocity in the swale (V):

$$\begin{aligned} V &= Q/A \\ V &= 0.39/1.06 \\ V &= 0.36 \text{ ft/sec } (< 1 \text{ ft/sec, OK}) \end{aligned}$$

6. Calculate the minimum length of the swale (L):

$$\begin{aligned} L &= 60 \times VT \\ L &= 60 \times 0.36 \times 7 \\ L &= 153 \text{ ft} \end{aligned}$$

7. Calculate the total area required (A_{BMP}):

$$\begin{aligned} A_{\text{BMP}} &= [b + 2z(f + y/12)] \times L \\ A_{\text{BMP}} &= [2.75 + 2 \times 3(0.5 + 3.5/12)] \times 153 \\ A_{\text{BMP}} &= 1,148 \text{ sq-ft} \end{aligned}$$

Other Design Considerations

- The calculated WQF may be reduced by 25% if the soil beneath the BMP is classified as Hydrologic Soils Group (HSG) “A” or “B”, as reported by the USDA Natural Resources Conservation Service (<http://websoilsurvey.nrcs.usda.gov/app/HomePage.htm>), or if the soil beneath the BMP is amended by incorporating 6 inches of compost/amendments and tilled up to 8 inches.
- In cases where a vegetated swale is located on-line, it should be sized as a treatment facility and as a conveyance system per the CCH’s standards for flood control.
- Vegetate the swale with dense turf grass to promote sedimentation, filtration, and nutrient uptake, and to limit erosion through maintenance of low flow velocities.
- Check dams may be used to achieve flow velocity requirements. They are often employed to enhance infiltration capacity, decrease runoff volume, rate, and velocity, and promote additional filtering and settling of nutrients and other pollutants.

Construction/Inspection Considerations

- Include directions in the specifications for use of appropriate fertilizer and soil amendments based on soil properties determined through testing and compared to the needs of the vegetation requirements.
- Install swales at the time of the year when there is a reasonable chance of successful establishment without irrigation; however, it is recognized that rainfall in a given year may not be sufficient and temporary irrigation may be used.
- If sod tiles must be used, they should be placed so that there are no gaps between the tiles; stagger the ends of the tiles to prevent the formation of channels along the swale or strip.
- Use a roller on the sod to ensure that no air pockets form between the sod and the soil.
- Where seeds are used, erosion controls will be necessary to protect seeds for at least 75 days after the first rainfall of the season.

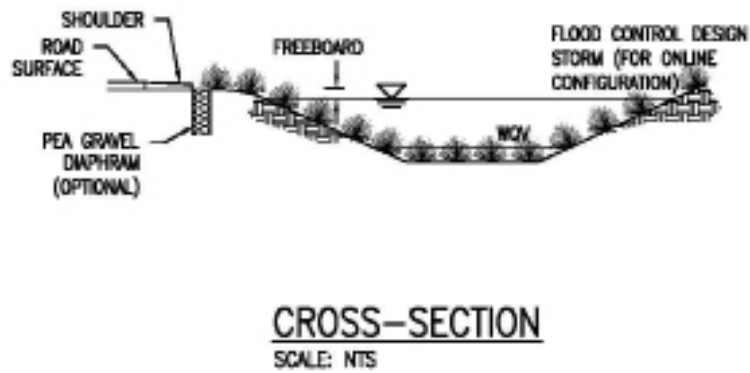
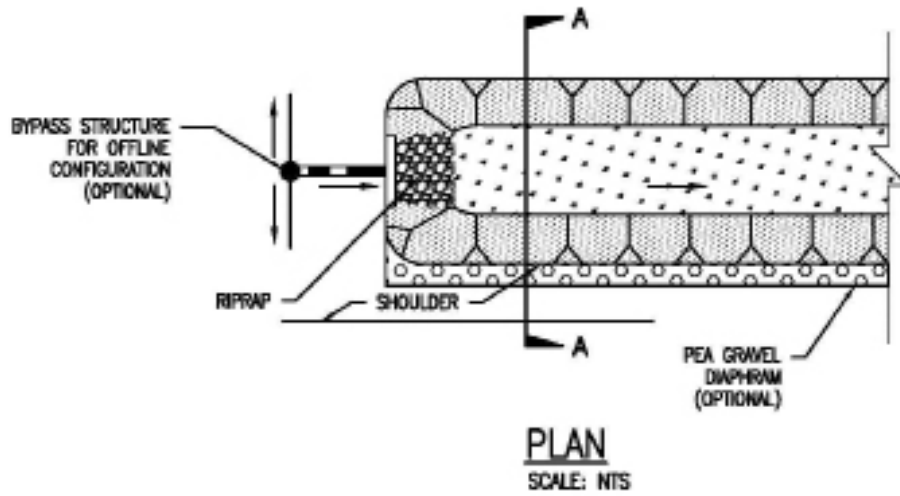

Schematic of a Vegetated Swale

TC-11: Vegetated Buffer Strip



BMP Category	
Retention	<input type="radio"/>
Biofiltration	<input checked="" type="radio"/>
Other	<input type="radio"/>

O&M Requirements
Low

Expected Pollutant Removals			
Nutrients	Low	Pesticides	Unknown
Sediment	Medium	Oil & Grease	Medium
Trash	Medium	Metals	Medium
Pathogens	Low	Organic Compounds	Medium

Virginia DCR Stormwater Design Specification No. 2. 2001.

Description

Sometimes referred to as a vegetated filter strip or biofiltration strip, a vegetated buffer strip is a grassy slope vegetated with turf grass that is designed to accommodate sheet flow. They may resemble natural ecological communities and remove pollutants by vegetative filtration.

Minimum Design Criteria

Design Parameter	Units	Value
Maximum Flow Velocity	feet/second	1
Maximum Upstream Area Flow Length	feet	75
Minimum Length	feet	15
Maximum Flow Depth	inches	1

Feasibility Criteria

See Section 5.5: Feasibility Criteria.

Sizing Procedure

- Step 1. Use the procedure presented previously to compute the WQF Rate.
- Step 2. Select values for the buffer strip width (w) and buffer strip longitudinal slope (s). Note that if a strip width is selected that is not the same as the width of the upstream flow path, a transition structure will be necessary to capture all the runoff and/ or establish uniform sheet flow across the entire strip width.

Step 3. Compute the design flow depth for the WQF using a simplified form of Manning's Equation assuming a shallow flow depth:

$$y = 12 \times [nQ/1.49\sqrt{(s/100)}]^{0.6}$$

Where	y	=	Design Flow Depth for WQF (in)
	n	=	Manning's n Value
	Q	=	WQF Rate from Step one (cu-ft/sec)
	w	=	Design Width from Step 2 (ft)
	s	=	Longitudinal Slope from Step 2 (percent)

Unless another value can be justified, use a Manning's n value of 0.25 for water quality calculations (lower values, such as 0.035, are only applicable for flood control calculations). If the calculated depth is greater than the maximum allowed depth, reduce the tributary area, increase the design width, or increase the longitudinal slope, and repeat the calculation.

Step 4. Calculate the Design flow velocity across the strip using the flow continuity equation:

$$V = 12Q/wy$$

Where	V	=	Design Flow Velocity (ft/sec)
	Q	=	WQF Rate from Step 1 (cu-ft/sec)
	w	=	Design Width from Step 2 (ft)
	d	=	Design Flow Depth from Step 3 (in)

If the design flow velocity is greater than the maximum allowed velocity, revise one or more design parameters and repeat the calculations.

Step 5. Select a design buffer strip length (L) equal to or greater than the minimum length, and calculate the total BMP area:

$$L = 20.0 \text{ ft}$$

$$A_{BMP} = L \times w$$

Where	A _{BMP}	=	Vegetated Buffer Strip Area (sq-ft)
	L	=	Design Length (ft)
	w	=	Design Width from Step 2 (ft)

Pretreatment Considerations

Vegetated Buffer Strips do not require pretreatment.

Area Requirements

A vegetated buffer strip requires a footprint equivalent to no less than 0.4% of its contributing impervious drainage area. While there is no upper value because there is no maximum design width or design length, the minimum footprint corresponds to the minimum length and the maximum slope and minimum width combination that provide the maximum allowable design depth.

Sizing Example

Calculate the size of a vegetated buffer strip serving the runoff from a one acre parking lot. Assume the following design parameters:

Design Parameter	Units	Value
Weighted Runoff Coefficient, C		0.95
Rainfall Intensity, i	inches/hour	0.4
Manning's n value	-	0.25
Longitudinal Slope		0.06

1. Calculate the WQF Rate:

$$\text{WQF} = CiA$$

$$\text{WQF} = 0.95 \times 0.4 \times 1.0$$

$$\text{WQF} = 0.38 \text{ cu-ft/sec}$$

2. Select a design buffer strip width (w) and longitudinal slope (s):

$$w = 20.0 \text{ ft}$$

$$s = 0.06$$

3. Calculate the depth of flow for the WQF (y):

$$y = 12 \times (\text{WQF} \times n / 1.49w\sqrt{s})^{0.6}$$

$$y = 12 \times [0.38 \times 0.25 / 1.49 \times 20\sqrt{(0.06)}]^{0.6}$$

$$y = 0.89 \text{ in } (\leq 1 \text{ in, OK})$$

4. Calculate the velocity across the buffer strip (V):

$$V = 12 \times \text{WQF} / (yw)$$

$$V = 12 \times 0.38 / (0.89 \times 20.0)$$

$$V = 0.26 \text{ cu-ft/sec } (\leq 1 \text{ cu-ft/sec, OK})$$

5. Select a design buffer strip length (L) at least equal to the minimum required length, and calculate the total BMP area (A_{BMP}):

$$A_{\text{BMP}} = L \times w$$

$$A_{\text{BMP}} = 20 \times 20$$

$$A_{\text{BMP}} = 400 \text{ sq-ft}$$

Other Design Considerations

- The calculated WQF may be reduced by 25% if the soil beneath the BMP is classified as Hydrologic Soils Group (HSG) “A” or “B,” as reported by the USDA Natural Resources Conservation Service (<http://websoilsurvey.nrcs.usda.gov/app/HomePage.htm>), or if the soil beneath the BMP is amended by incorporating 6 inches of compost/ amendments and tilled up to 8 inches.
- A pea gravel diaphragm or engineered level spreader should be provided at the upper edge of the BMP when the width of the contributing drainage area is greater than that of the filter. Level spreader options include porous pavement strips, stabilized turf strips, slotted curbing, rock-filled trench, or concrete sills.
- The selection of plants should be based on their compatibility with climate conditions, soils and topography, and their ability to tolerate urban stresses from pollutants, variable soil moisture conditions and ponding fluctuations.

Construction/Inspection Considerations

Vegetated filter strips should be protected with temporary sediment and erosion control BMPs until contributing areas are stabilized.

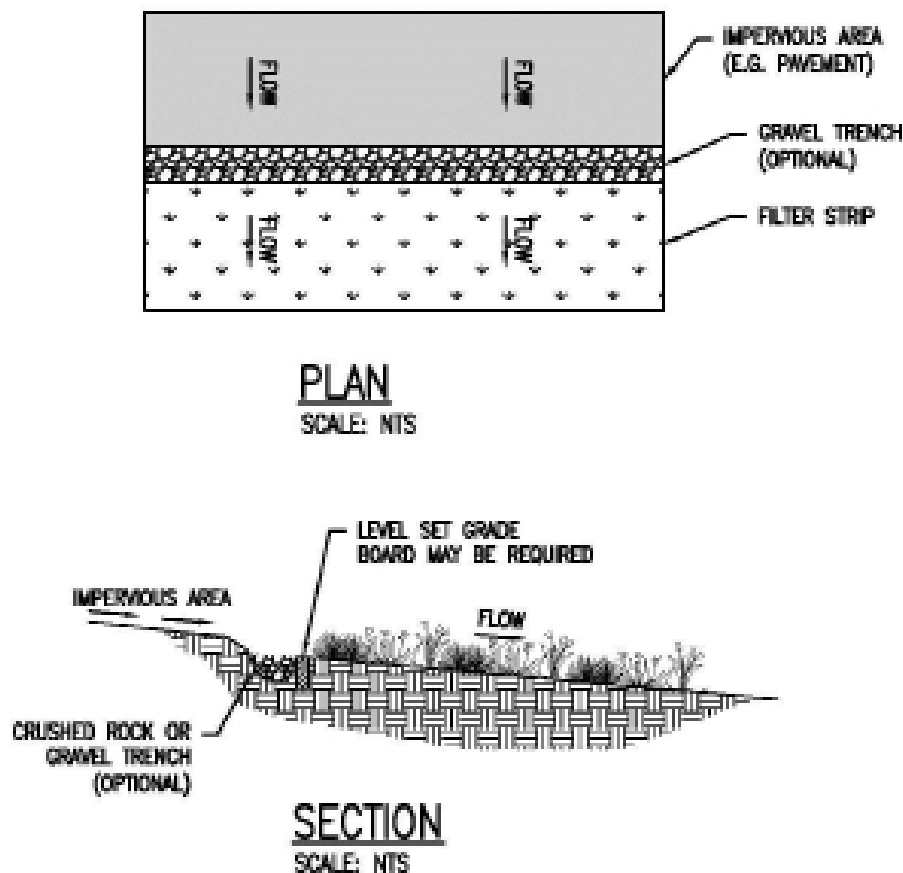

Schematic of a Vegetated Buffer Strip

TC-12: Harvest/Reuse



Hawaii Baptist Academy (Courtesy of Group 70)

BMP Category	
Retention	●
Biofiltration	○
Other	○

O&M Requirements
Low

Expected Pollutant Removals			
Nutrients	Low	Pesticides	Unknown
Sediment	Medium	Oil & Grease	Medium
Trash	Medium	Metals	Medium
Pathogens	Low	Organic Compounds	Medium

Description

Sometimes referred to as capture/reuse or rainwater harvesting, is the collection and temporary storage of roof runoff in rain barrels or cisterns for subsequent non-potable outdoor use (landscape irrigation, vehicle washing).

Minimum Design Criteria

One of two equivalent performance standards shall be met:

1. Harvest and use BMP is designed to capture at least 80% of average annual (long term) runoff volume and meet 80% of the annual overall demand.
2. Harvest and use BMPs are sized to drain the tank in 48 hrs following the end of rainfall. The size of the BMP is dependent on the demand at the site.

It is rare cisterns can be sized to capture the full WQV and use this volume in 48 hrs. So when using Infeasibility worksheets in the *Water Quality Rules* Appendix F, if it is determined that harvest and use BMP is feasible then the BMP should be sized to the estimated 48-hr demand. The remaining WQV not captured needs to be either retained onsite or, if infeasible, treated with biofiltration per the requirements in Section 1.3.

Feasibility Criteria

See Section 5.5: Feasibility Criteria.

Sizing Procedure

- Step 1. Define the irrigation demand by selecting values for the irrigation area (A_i), pan evaporation coefficient (K_p), landscape coefficient (K_l), irrigation system efficiency (e). Unless specific data is available, use a value of 0.80 for K_p (*Guidelines for the Reuse of Gray Water*), 0.60 for

K_1 (warm season turfgrass, *A Guide to Estimating Irrigation Water Needs of Landscape Plantings in California*), and 0.90 for e (well-designed system, *Estimating Irrigation Water Needs of Landscape Plantings in California*).

- Step 2. Define the non-irrigation demand (D_0) which may include other non-potable use.
- Step 3. Define the runoff available for reuse by selecting values for the drainage (i.e., roof) area (A_d), percent of impervious cover (I), and cistern size (C).
- Step 4. Identify the project's nearest reference point (Makakilo City, Waimanalo, Waialua, Village Park, Waianae, UH Mauka, Mililani, Opaepa, Maunawili, and Kalihi Valley) and use the corresponding monthly rainfall rates and monthly pan evaporation rates (E_{pan}).
- Step 5. Perform a month-to-month analysis, starting with January and ending with December. Set the beginning cistern volume in January to 0.

- Step 5a. Calculate the reference evapotranspiration rate for the month using the pan evaporation rate and the pan evaporation coefficient:

$$ET_0 = E_{pan} \times K_p$$

- Where ET_0 = Reference Evapotranspiration Rate for the Month (in)
 E_{pan} = Pan Evaporation Rate for the Month (in) from Step 4
 K_p = Pan Evaporation Coefficient from Step 1

- Step 5b. Calculate the actual evapotranspiration rate for the month using the reference evapotranspiration rate and the landscape coefficient:

$$ET_a = ET_0 \times K_l$$

- Where ET_a = Actual Evapotranspiration Rate for the Month (in)
 ET_0 = Reference Evapotranspiration Rate from Step 5a
 K_l = Landscape Coefficient from Step 1

- Step 5c. Calculate the total demand for the month by multiplying the irrigation area by the difference between the actual evapotranspiration rate and the rainfall, and adding the non-irrigation demand:

$$D_t = 7.48 \times A \times (ET_a - r) / (12 \times e) + D_0$$

- Where D_t = Total Demand for the Month (gallons)
 A = Irrigation Area from Step 1 (sq-ft)
 ET_a = Actual Evapotranspiration Rate from Step 5b
 r = Total Rainfall for the Month (in) from Step 4
 e = Irrigation System Efficiency from Step 1
 D_0 = Other Non-Irrigation Demand for the Month (gallons) from Step 2

If the total demand for the month is negative (because the rainfall amount exceeds the evapotranspiration rate), set the total demand to 0.

Step 5d. Calculate the amount of runoff generated for the month by multiplying the drainage area by the rainfall by the volumetric runoff coefficient:

$$R_g = 7.48 \times A_d \times r \times (0.05 + 0.009 \times I)/12$$

Where R_g = Runoff Generated for the Month (gallons)
 A_d = Drainage Area from Step 2 (sq-ft)
 r = Total Rainfall for the Month (in) from Step 4
 I = Percent of Impervious Cover from Step 3 (percent)

Step 5e. Compare the total demand (D_t) to the amount of runoff in the cistern at the beginning of the month (C_b) plus the runoff generated during the month (R). If the monthly demand is greater, set the amount of runoff reused (R_u) to the sum of C_b and R . If the monthly demand is less, set the amount of runoff reused to D_t .

Step 5f. Compare the Cistern capacity (C) to the amount in the cistern at the beginning of the month (C_b) plus the Runoff generated during the month (R_g) minus the amount of runoff used (R_u). Set the amount of runoff in the cistern at the end of the month (C_e) to the lower of the two values.

Step 5g. Calculate the amount of cistern overflow by the following:

$$O = C_b + R_g - D_t - C_e$$

Where O = Total Cistern Overflow for the Month (gallons)
 C_b = Amount of Runoff in Cistern at the beginning of the Month (gallons)
 R_g = Runoff Generated for the Month (gallons)
 D_t = Total Demand for the Month (gallons)
 C_e = Amount of Runoff in Cistern at the end of the Month (gallons)

If the overflow is negative (because the amount of runoff in the cistern at the end of the month is less than the cistern capacity), set the overflow to 0.

Step 5h. Calculate the amount of runoff captured in the cistern by subtracting the Overflow from the amount of runoff generated:

$$R_c = R_g - O$$

Where R_c = Runoff Capture in the Cistern for the Month (gallons)
 R_g = Runoff Generated for the Month (gallons)
 O = Total Cistern Overflow for the Month (gallons)

Step 5i. Set the beginning cistern amount for the next month equal to the ending cistern amount for the current month. Repeat Steps 5 through 13 for each subsequent month. Continue on to Step 5 after Steps 4a through 4i have been performed for all 12 months.

Step 6. Calculate the overall runoff capture efficiency by dividing the cumulative runoff captured by the cumulative runoff generated:

$$E_c = 100 \times \frac{\sum_{1}^{12} R_c}{\sum_{1}^{12} R_g}$$

Where E_c = Overall Runoff Capture Efficiency (percent)
 R_c = Runoff Capture from each Month (gallons)
 R_g = Runoff Generated from each Month (gallons)

If the calculated efficiency is below the minimum design criteria value, revise one or more of the following parameters and return to Step 3: drainage area (A_d), cistern size (C), irrigation area (A_i), and other non-irrigation demand (D_0).

Step 7. Calculate the overall demand met efficiency by dividing the cumulative runoff used by the cumulative demand:

$$E_d = 100 \times \frac{\sum_{1}^{12} R_u}{\sum_{1}^{12} D_t}$$

Where E_d = Overall Demand Met Efficiency (percent)
 R_u = Runoff Used from each Month (gallons)
 D_t = Total Demand from each Month (gallons)

If the calculated efficiency is below the minimum design criteria value, revise one or more of the following parameters and return to Step 3: drainage area (A_d), cistern size (C), irrigation area (A_i), and other non-irrigation demand (D_0).

Pretreatment Considerations

Roof gutter guards or leaf gutter screens are required for roof runoff to reduce dry well clogging from sediment, leaves, and other organic material.

Area Requirements

Rain barrel/cistern sizes can vary greatly depending on the project area, roof size, and irrigation area. The size can be anywhere from less than 1,000 gallons to more than 10,000 gallons per 1,000 sq-ft of roof area.

Sizing Example

Calculate the size of a cistern serving the roof runoff from an 800 sq-ft auto repair shop in Kapolei. Assume the following design parameters:

Design Parameter	Units	Value
Minimum overall runoff capture efficiency, E_c	percent	80
Minimum overall demand met efficiency, E_d	percent	80

1. Select initial demand values for the Irrigation Area (A_i), pan evaporation coefficient (K_p), landscape coefficient (K_l), irrigation system efficiency (e), and non-irrigation demand (D_0):

$$\begin{aligned} A_i &= 115 \text{ sq-ft} \\ K_p &= 0.80 \\ K_l &= 0.60 \\ e &= 0.90 \\ D_0 &= 0 \end{aligned}$$

2. Select initial values for the drainage area (A_d), percent of impervious cover (I), and cistern size (C):

$$\begin{aligned} A_d &= 800 \text{ sq-ft} \\ I &= 100\% \\ C &= 5,000 \text{ gallons} \end{aligned}$$

3. The nearest reference point to Kapolei is Makakilo City.

- 4a. Calculate the monthly reference evapotranspiration rates (ET_0). The calculation for January is as follows, and the results for the entire year are provided in the table in #4c.

$$\begin{aligned} ET_0 &= E_{\text{pan}} \times K_l \\ ET_0 &= 5.46 \times 0.8 \\ ET_0 &= 4.37 \text{ in} \end{aligned}$$

- 4b. Calculate the actual evapotranspiration rates (ET_a). The calculation for January is as follows, and the results for the entire year are provided in the table in #4c.

$$\begin{aligned} ET_a &= ET_0 \times K_l \\ ET_a &= 4.37 \times 0.6 \\ ET_a &= 2.62 \text{ in} \end{aligned}$$

4c. Calculate the total demand (D_t). The calculation for January is as follows, and the results for the entire year are provided in the table below.

$$D_t = 7.48A_i(ET_i - r)/(12e) + D_0$$

$$D_t = 7.48 \times 115 \times (2.62 - 2.58)/(12 \times 0.9) + 0$$

$$D_t = 3 \text{ gallons}$$

Month	Rainfall (inches)	P (inches)	ET ₀ (inches)	ET _a (inches)	D _t (gallons)
January	2.58	5.46	4.37	2.62	3
February	3.05	5.75	4.60	2.76	0
March	1.87	7.12	5.70	3.42	123
May	1.12	7.75	6.20	3.72	207
May	0.86	8.41	6.73	4.04	253
June	0.55	8.99	7.19	4.32	300
July	0.58	9.74	7.79	4.68	326
August	0.48	9.65	7.72	4.63	331
September	0.74	8.48	6.78	4.07	265
October	2.00	7.54	6.03	3.62	129
November	2.06	6.29	5.03	3.02	76
December	2.69	5.59	4.47	2.68	0

4d. Calculate the generated roof runoff (R_g). The calculation for January is as follows, and the results for the entire year are provided in the table below:

$$R_g = 7.48A_d r (0.05 + 0.009I)/12$$

$$R_g = 7.48 \times 800 \times 2.58 (0.05 + 0.009 \times 100)/12$$

$$R_g = 1,222 \text{ gallons}$$

4e. Calculate the runoff used (R_u) by comparing the total demand (D_t) to the amount of runoff in the cistern at the beginning of the month (C_b) plus the runoff generated during the month (R). The calculation for January is as follows, and the results for the entire year are provided in the table below:

$$C_b = 0 \text{ gallon}$$

$$R_u = D_t = 3 \text{ gallons [since } R_g + C_b > D_t \text{]}$$

4f. Calculate the amount of runoff in the Cistern at the end of the month (C_e) by setting it to the lower value of the amount of runoff in the Cistern at the beginning of the month (C_b) plus the runoff generated (R_g) minus the runoff used (R_u), and the cistern capacity (C). The calculation for January is as follows, and the results for the entire year are provided in the table below:

$$C_e = \min(C_b + R_g - R_u, C)$$

$$C_e = \min(0 + 1,222 - 3, 500)$$

$$C_e = 1,219 \text{ gallons}$$

4g. Calculate the Cistern overflow (O). The calculation for January is as follows, and the results for the entire year are provided in the table below:

$$\begin{aligned}
 O &= C_b + R_g - D_t - C_c \\
 O &= 0 + 1,222 - 3 - 1,219 \\
 O &= 0 \text{ gallons}
 \end{aligned}$$

4h. Calculate the runoff captured in Cistern (R_c). The calculation for January is as follows, and the results for the entire year are provided in the table below:

$$\begin{aligned}
 R_c &= R_g - O \\
 R_c &= 1,222 - 0 \\
 R_c &= 1,222 \text{ gallons}
 \end{aligned}$$

4i. Set C_b for the next month equal to C_c of the previous month and repeat the calculations.

Month	r (inches)	D (gallons)	R _g (gallons)	C _b (gallons)	C _c (gallons)	R _u (gallons)	O (gallons)	R (gallons)
January	2.58	3	1,222	0	1,219	3	0	1,222
February	3.05	0	1,445	1,219	2,664	0	0	1,445
March	1.87	123	886	2,664	3,426	123	0	886
May	1.12	207	531	3,426	3,750	207	0	531
May	0.86	253	407	3,750	3,904	253	0	407
June	0.55	300	261	3,904	3,865	300	0	261
July	0.58	326	275	3,865	3,814	326	0	275
August	0.48	331	227	3,814	3,710	331	0	227
September	0.74	265	351	3,710	3,796	265	0	351
October	2.00	129	947	3,796	4,614	129	0	947
November	2.06	76	976	4,614	5,000	76	514	462
December	2.69	0	1,274	5,000	5,000	0	1,274	0
Total	18.58	2,014	8,802			2,014	1,788	7,014

5. Calculate the overall runoff capture efficiency (E_c) and overall demand efficiency (E_d):

$$\begin{aligned}
 E_c &= 100 \times \frac{\sum_{1}^{12} R_c}{\sum_{1}^{12} R_g} \\
 E_c &= 100 \times 7,014/8,802 \\
 E_c &= 80\%
 \end{aligned}$$

$$\begin{aligned}
 E_d &= 100 \times \frac{\sum_{1}^{12} R_u}{\sum_{1}^{12} D_t} \\
 E_d &= 100 \times 2,014/2,014 \\
 E_d &= 100\%
 \end{aligned}$$

6. Calculate the WQV for which credit is received:

$$WQV = PCA \times 3,360$$

$$WQV = 1 \times (0.05 + 0.009 \times 100) \times (800/43,560) \times 3,360$$

$$WQV = 63 \text{ cu-ft}$$

Other Design Considerations

- Local pan evaporation and rainfall data may be used if available.
- Tanks should have tight fitting covers to exclude contaminants and animals, and above ground tanks should not allow penetration of sunlight to limit algae growth
- In areas where the tank is to be buried partially below the water table, special design features must be employed to keep it from “floating.”

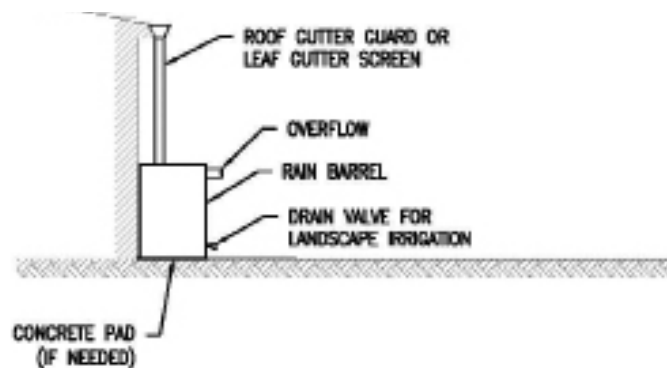

TYPICAL SECTION RAIN BARREL
SCALE: NTS

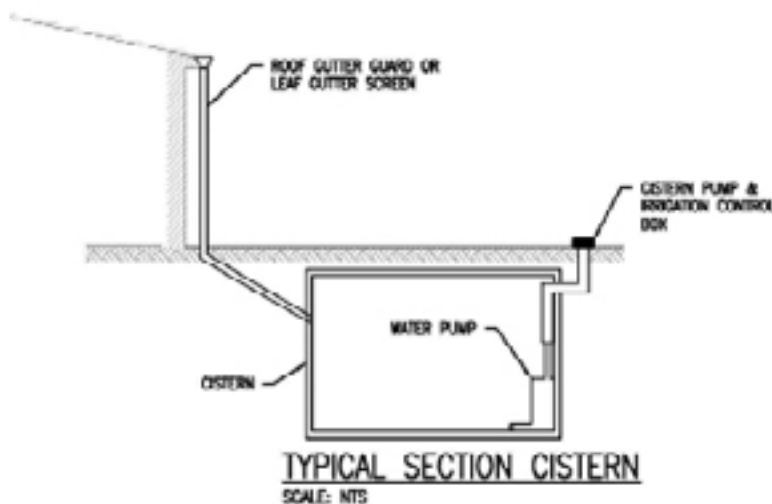

TYPICAL SECTION CISTERN
SCALE: NTS

Schematic of a Harvesting/Reuse System

TC-13: Detention Basin



Miliani Mauka

BMP Category	
Retention	<input type="radio"/>
Biofiltration	<input type="radio"/>
Other	<input checked="" type="radio"/>

O&M Requirements
Low

Expected Pollutant Removals			
Nutrients	Low	Pesticides	Unknown
Sediment	Medium	Oil & Grease	Medium
Trash	High	Metals	Low/Med
Pathogens	Low	Organic Compounds	Unknown

Description

Sometimes referred to as a dry extended detention basin, a detention basin is a shallow man-made impoundment intended to provide for the temporary storage of storm water runoff to allow particles to settle. It does not have a permanent pool and is designed to drain between storm events.

Minimum Design Criteria

Design Parameter	Units	Value
Maximum Interior Side Slope (length per unit height)		3:1
Minimum length to width ratio		2:1
Maximum depth	feet	8
Drawdown (drain) time for WQV	hours	48
Drawdown (drain) time for 50% of WQV	hours	24-36
Basin invert slope	percent	1-2
Minimum outlet size	inches	4
Minimum freeboard	feet	1

Feasibility Criteria

Detention Basins are considered infeasible for any of the following conditions:

- Basin invert would be below seasonally high groundwater table.
- Unable to operate off-line and unable to operate in-line with safe overflow mechanism.
- Excavation would disturb iwi kupuna or other archaeological resources.
- Unable to meet minimum length to width ratio design criteria naturally or artificially.

Sizing Procedure

Detention Basins are sized using detailed routing calculations to demonstrate that the storage volume is adequate. However, a reasonable first estimate can be determined using the following simple routing method which assumes triangular hydrographs for the inflow and outflow.

Step 1. Use the procedure presented previously to compute the pre-project (i.e., undeveloped) and post-project (i.e., developed) weighted runoff coefficients.

Step 2. Compute the peak inflow rate using the Rational Method:

$$q_i = C_a i A$$

Where q_i = Peak Inflow Rate into Basin (cu-ft)
 C_a = Post-Project Weighted Runoff Coefficient
 i = Peak Rainfall Intensity (in/hr)
 A = Drainage Area (acres)

Step 3. Compute the peak outflow rate using the pre-project runoff coefficient, which effectively forces the detention basin to maintain pre-project discharge rates:

$$q_o = C_b i A$$

Where q_o = Peak Inflow Rate leaving Basin (cu-ft)
 C_b = Pre-Project Weighted Runoff Coefficient
 i = Peak Rainfall Intensity (in/hr)
 A = Drainage Area (acres)

Step 4. Calculate the estimated basin storage volume:

$$s = 3,630 \times PA [1 - (q_o/q_i)]$$

Where s = Storage Volume in the Basin (cu-ft)
 P = Design Storm Runoff Depth (in)
 A = Drainage Area (acres)
 q_o = Peak Outflow Rate from Step 3 (cu-ft)
 q_i = Peak Inflow Rate from Step 2 (cu-ft)

Step 5. Select initial values for the detention basin total width (w_t), total length (l_t), and depth (d) based on space availability, topography and existing drainage facilities. Also select values for the interior side slopes (z) and required freeboard (f). Calculate the basin invert width and invert length:

$$w_b = w_t - 2z(d+f)$$

$$l_b = l_t - 2z(d+f)$$

Where	w_b	=	Basin Bottom Width (ft)
	l_b	=	Basin Bottom Length (ft)
	w_t	=	Basin Total Width (ft)
	l_t	=	Basin Total Length (ft)
	z	=	Basin Interior Side Slope (length per unit height)
	d	=	Depth of Flow for Storage Volume (ft)
	f	=	Freeboard (ft)

Step 6. Calculate the resulting storage volume using the prismoidal formula for trapezoidal basins:

$$V = w_b l_b d + (w_b + l_b) z d^2 + 4z^2 d^3 / 3$$

Where	V	=	Volume of Trapezoidal Basin (cu-ft)
	w_b	=	Basin Bottom Width from Step 5 (ft)
	l_b	=	Basin Bottom Length from Step 5 (ft)
	d	=	Depth of Flow for Storage Volume from Step 5 (ft)
	z	=	Basin Interior Side Slope from Step 5

Compare the calculated volume (V) to the required volume (s) from Step 4. If the calculated volume is greater than or equal to the required volume, the selected dimensions (w_t and l_t) and depth (d) are adequate for preliminary design. If the calculated volume is less than the required volume, increase one or both of the dimensions and/or the depth (d) and repeat Steps 5 and 6. If the footprint area and depth are set to maximum allowable values based on site characteristics and the calculated volume is still less than the required volume, reduce the drainage area (A) and repeat Steps 2 through 6.

Pretreatment Considerations

If significant amounts of sediment or sand are anticipated at the site, sediment forebays should be located at each major inlet to provide pretreatment, preserve the capacity of the basin, and reduce maintenance requirements in the basin. The forebay consists of a separate cell that drains into the main basin, formed by an acceptable barrier, such as an earthen berm or gabion baskets, etc.). If used, the total volume of all forebays should be at least 5% of the total WQV.

Area Requirements

A detention basin requires a footprint equivalent to 1% - 9% of its contributing impervious drainage area. The actual value is dependent on a number of variables, including the drainage area, pre-project and post-

project runoff coefficients, and basin depth. Footprints at the lower range reflect deep basins (e.g., 8 ft) serving large drainage areas (e.g., 50 acres), while footprints at the upper range reflect shallow basins (e.g., 1 ft) serving small drainage areas (e.g., 1 acre).

Sizing Example

Calculate the preliminary size of a detention basin serving the runoff from a one acre parking lot. Assume the following design parameters:

Design Parameter	Units	Value
Rainfall Intensity, i	inches/hour	0.4
Runoff Volume, Q	inches	1
Basin Interior Side Slope (length per unit height), z		3
Freeboard, f	feet	1

1. Compute the pre-project (i.e., undeveloped) and post-project (i.e., developed) weighted runoff coefficients:

$$C_b = 0.20$$

$$C_a = 0.95$$

2. Compute the peak inflow rate:

$$q_i = C_a i A$$

$$q_i = 0.95 \times 0.40 \times 1$$

$$q_i = 0.38 \text{ cu-ft}$$

3. Compute the peak outflow rate:

$$q_o = C_b i A$$

$$q_o = 0.20 \times 0.40 \times 1$$

$$q_o = 0.08 \text{ cu-ft}$$

4. Calculate the estimated basin storage volume:

$$s = 3,630 \times PA[1 - (q_o/q_i)]$$

$$s = 3,630 \times 1 \times 1 \times [1 - (0.08/0.38)]$$

$$s = 2,866 \text{ cu-ft}$$

5. Select initial values for the detention basin total width (w_t), total length (l_t), depth (d), interior side slopes (z) and required freeboard (f):

$$w_t = 38 \text{ ft}$$

$$l_t = 53 \text{ ft}$$

$$d = 3.5 \text{ ft}$$

$$z = 3 \text{ ft}$$

$$f = 1 \text{ ft}$$

Calculate the basin bottom width and length:

$$\begin{aligned}w_b &= w_t - 2z(d + f) \\w_b &= 38 - 2 \times 3 \times (3.5 + 1) \\w_b &= 11 \text{ ft}\end{aligned}$$

$$\begin{aligned}l_b &= l_t - 2z(d + f) \\l_b &= 53 - 2 \times 3 \times (3.5 + 1) \\l_b &= 26 \text{ ft}\end{aligned}$$

6. Calculate the resulting storage volume using the prismoidal formula for trapezoidal basins:

$$\begin{aligned}V &= w_b l_b d + (w_b + l_b) z d^2 + 4z^2 d^3 / 3 \\l_t &= 11 \times 26 \times 3.5 + (11 + 26) \times 3 \times 3.5^2 + 4 \times 3^2 \times 3.5^3 / 3 \\d &= 2,875 \text{ cu-ft}\end{aligned}$$

The calculated volume is greater than the required volume, so the preliminary design is acceptable.

Other Design Considerations

- Credit for infiltration may be given if the soils beneath the detention basin invert have a measured infiltration rate of at least 0.5 inches per hour and none of the infeasibility criteria for infiltration basins are applicable. However, low flow channels should not be included if infiltration is expected.
- If a temporarily-filled pond creates a potential public safety issue, perimeter fencing may be considered. Warning signs should be used wherever appropriate
- In order to meet designs storm requirements, detention basins should have a multistage outlet structure. Three elements are typically included in this design:
 1. A low-flow outlet that controls the extended detention and functions to slowly release the water quality design storm.
 2. A primary outlet that functions to attenuate the peak of larger design storms.
 3. An emergency overflow outlet/spillway
- Design methodology options are provided in manuals included in the References, including the Georgia Stormwater Management Manual, the Urban Storm Drainage Criteria Manual, and the USEPA Stormwater Best Management Practice Design Guide.

Construction/Inspection Considerations

- Inspect facility after first large storm to determine whether the desired residence time has been achieved.
- When constructed with small tributary area, orifice sizing is critical and inspection should verify that flow through additional openings such as bolt holes does not occur.

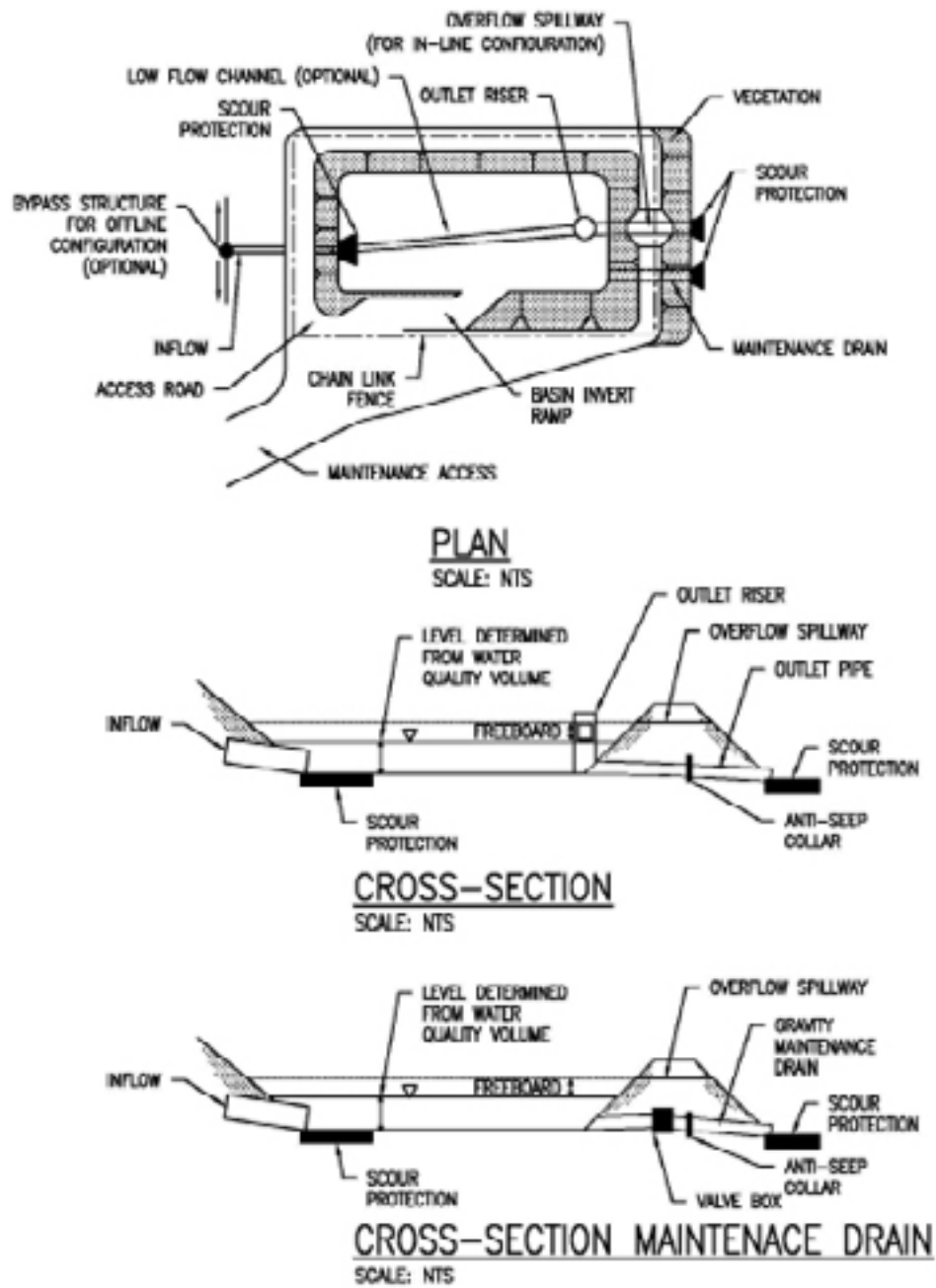

Schematic of a Detention Basin

TC-14: Manufactured Treatment Device



BMP Category		O&M Requirements
Retention	<input type="radio"/>	Low to Medium
Biofiltration	<input type="radio"/>	
Other	<input checked="" type="radio"/>	

Expected Pollutant Removals
Varies based on System

Description

A manufactured treatment device is a proprietary water quality structure utilizing settling, filtration, adsorptive/absorptive materials, vortex separation, vegetative components, or other appropriate technology to remove pollutants from storm water runoff.

Minimum Design Criteria

Design Parameter	Units	Value
Minimum Total Suspended Solids water (TSS) Removal	Percent	80

Feasibility Criteria

Manufactured treatment devices are considered infeasible for any of the following conditions:

- Bottom of BMP is below seasonally high groundwater table.
- Unable to operate off-line and unable to operate in-line with safe overflow mechanism.
- Excavation would disturb iwi kupuna or other archaeological resources.

Sizing Procedure

Follow the manufacturer's guidelines for appropriate sizing calculations and selection of appropriate device/model.

Pretreatment Considerations

No pretreatment is required.

Area Requirements

The footprint requirements for proprietary manufactured treatment devices vary by manufacturer.

Sizing Example

No example is provided as sizing procedures vary by manufacturer, and presenting any specific product might be interpreted as an endorsement.

Other Design Considerations

- The device must provide a TSS removal rate of 80%, certified for general use by the Washington State Department of Ecology Technology Assessment Protocol (TAPE) or certified by the New Jersey Department of Environmental Planning (NJDEP).
- Systems not meeting the required TSS removal criteria can be used as pre-treatment for other BMPs.
- Although the device must meet TSS requirements, many manufactured treatment devices also treat other pollutants. The City recommends selecting devices capable of treating the potential pollutants at your site.
- All manufactured treatment devices must be able to safely overflow or bypass flows in excess of the storm water quality design storm to downstream drainage systems.

Construction/Inspection Considerations

Follow manufacturer's recommendations.

TC-15: Sand Filter



Portland Stormwater Management Manual, 2004.

BMP Category	
Retention	<input type="radio"/>
Biofiltration	<input type="radio"/>
Other	<input checked="" type="radio"/>

O&M Requirements
Medium

Expected Pollutant Removals			
Nutrients	Low/Med	Pesticides	Unknown
Sediment	High	Oil & Grease	High
Trash	High	Metals	Med/High
Pathogens	Medium	Organic Compounds	Med/High

Description

A sand filter is an open chambered structure that captures, temporarily stores, and treats storm water runoff by passing it through sand.

Minimum Design Criteria

Design Parameter	Units	Value
Sand Coefficient of Permeability	feet/day	3.5
Filter media depth	inches	18
Drawdown (drain) Time	hours	48
Maximum Interior Side Slope if earthen (length per unit height)		3:1
Minimum Underdrain Diameter	inches	6

Feasibility Criteria

Sand filters are considered infeasible for any of the following conditions:

- Bottom of BMP is below seasonally high groundwater table.
- Unable to operate off-line and unable to operate in-line with safe overflow mechanism.
- Excavation would disturb iwi kupuna or other archaeological resources.
- Site lacks sufficient hydraulic head to support BMP operation by gravity.

Sizing Procedure

Step 1. Use the procedure presented previously to compute the Volumetric Runoff Coefficient and WQV.

Step 2. Select values for the filter media depth (l_m) and maximum ponding depth (d_p).

Step 3. Use Darcy's Law to calculate the required Filter Bed Surface Area:

$$A_{fb} = (WQV \times l_m) / [k(l_m + d_p/24)(t/24)]$$

Where	A_{fb}	=	Filter Bed Surface Area (sq-ft)
	WQV	=	WQV from Step 1 (cu-ft)
	l_m	=	Filter Media Depth from Step 2 (ft)
	k	=	Filter Media Permeability Coefficient (ft/day)
	d_p	=	Maximum Ponding Depth from Step 2 (in)
	t	=	Filter Bed Drain Time (hr)

Step 4. Calculate the total area occupied by the BMP (A_{BMP}) using the embankment side slopes and assuming a square basin:

$$A_{BMP} = [\sqrt{A_{fb}} + 2z(d_p/12 + f)]^2$$

Where	A_{BMP}	=	Area Occupied by BMP (sq-ft)
	A_{fb}	=	Filter Bed Surface Area from Step 3 (sq-ft)
	z	=	Filter Bed Interior Side Slope (length per unit height)
	d_p	=	Maximum Ponding Depth from Step 2 (in)
	f	=	Freeboard (ft)

If the calculated area does not fit in the available space, either reduce the drainage area, increase the ponding depth, and/or increase the interior side slope (if it's not already set to the maximum) and repeat the calculations.

Pretreatment Considerations

Pretreatment is required for sand filters in order to reduce the sediment load entering the sand bed, prevent premature clogging, and ensure filter longevity. The pretreatment device must be sized for at least 25% of the WQV, and may be achieved with vegetated swales, vegetated filter strips, sedimentation basins or forebays, sedimentation manholes, and manufactured treatment devices. The typical method is a sedimentation basin that has a length to width ratio of 2:1, and is sized using the Camp-Hazen equation.

Area Requirements

A sand filter requires a footprint equivalent to 1.5% - 3% of its contributing impervious drainage area, excluding pretreatment. The lower value reflects minimum filter media and ponding depths, while the upper value reflects higher filter media and ponding depths.

Sizing Example

Calculate the size of a sand filter serving a 1-acre residential development. Assume the following design parameters:

Design Parameter	Units	Value
Percent Impervious Cover, I	percent	70
Design Storm Depth, P	inches	1.0
Sand Coefficient of Permeability, k	feet/day	3.5
Interior Side Slope (length per unit height)		3:1
Freeboard	feet	0.5
Drawdown (drain) Time, t	hours	48

1. Calculate the volumetric runoff coefficient and WQV:

$$C = 0.05 + 0.009I$$

$$C = 0.05 + 0.009 \times 70$$

$$C = 0.68$$

$$WQV = PCA \times 3,630$$

$$WQV = 1 \times 0.68 \times 1 \times 3,630$$

$$WQV = 2,468 \text{ cu-ft}$$

2. Select a filter media depth (l_m) and maximum ponding depth (d_p):

$$l_m = 1.5 \text{ ft}$$

$$d_p = 24 \text{ in}$$

3. Calculate the Filter Bed Surface Area (A_{fb}):

$$A_{fb} = (WQV \times l_m) / [k(l_m + d_p/24)(t/24)]$$

$$A_{fb} = (2,468 \times 1.5) / [3.5(1.5 + 24/24)(48/24)]$$

$$A_{fb} = 212 \text{ sq-ft}$$

4. Calculate the total area occupied by the BMP (A_{BMP}):

$$A_{BMP} = [\sqrt{A_{fb}} + 2z(d_p/12 + f)]^2$$

$$A_{BMP} = [\sqrt{212} + 2 \times 3(24/12 + 0.5)]^2$$

$$A_{BMP} = 873 \text{ sq-ft}$$

Other Design Considerations

- A flow spreader should be installed at the inlet along one side of the filter to evenly distribute incoming runoff across the filter and to prevent erosion of the filter device.
- A cleanout pipe should be tied into the end of all underdrain pipe runs.

Construction/Inspection Considerations

Tributary area should be completely stabilized before media is installed to prevent premature clogging.

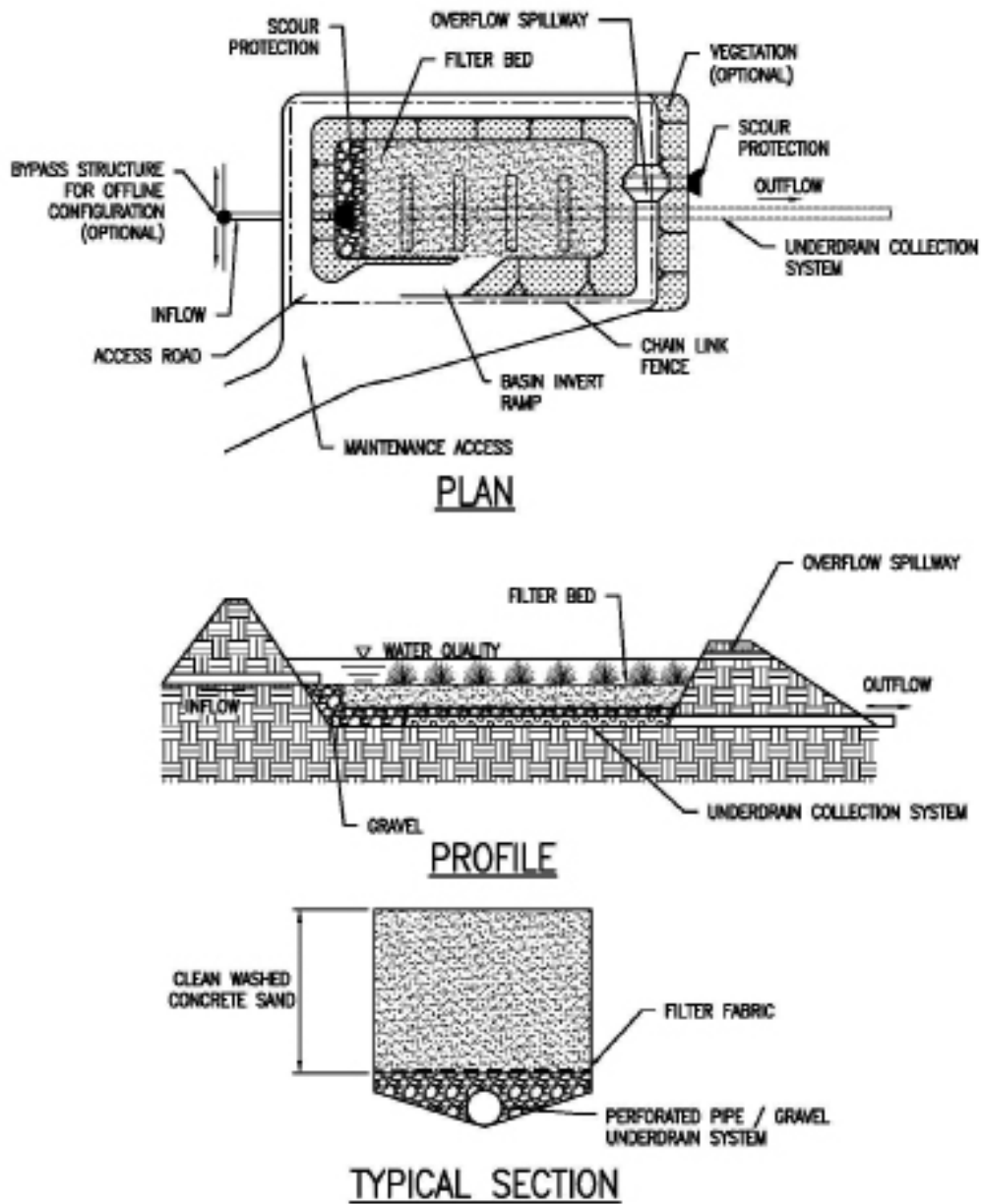

Schematic of a Sand Filter

Appendix C: O&M Fact Sheets

This section describes minimum inspection and maintenance requirements for post-construction BMPs. Actually inspection and maintenance may be more frequent to ensure long-term performance of post-construction BMPs than what is suggested. Maintenance should be performed whenever needed, based on maintenance indicators presented in the fact sheets below.

The fact sheets have been grouped into the following categories based on common maintenance requirements:

- Bio-Retention Basin
- Detention Basin
- Green Roof
- Infiltration Trench/Basin
- Manufactured Treatment Device
- Pervious Pavement
- Rainwater Harvesting
- Sand Filter
- Vegetated Biofilter
- Vegetated Swale/Strip

This page is intentionally left blank.

OM-01: Bio-Retention Basin

• Bio-Retention Basin • Rain Garden

This category includes BMPs that treat storm water by infiltrating it through vegetation and/or soil. Regular inspection and maintenance is needed to ensure flow is unobstructed, erosion is prevented, and soils are biologically active. General conditions when maintenance is needed and the associated maintenance action triggered by those conditions are provided below.

Monthly or as Needed After Storm Event

- Remove obstructions, debris and trash from bio-retention area and dispose of properly.
- Inspection bio-retention area for ponded water.
- Inspect inlets for channeling, soil exposure or other evidence of erosion. Clear obstructions and remove sediment.
- Inspect depth of mulch and replenish as necessary (2 inches per soil specifications).

Bi-Annually

- Maintain vegetation and irrigation system.
- Prune, weed and remove/replace any dead plants.

Annually

- Inspect energy dissipation at the inlet.

Condition When Maintenance is Needed

Results When Maintenance is Performed

Standing Water

Water stands in the bio-retention area between storms and does not drain within 24 hrs after rainfall.

Any of the following results could apply: sediment or trash blockages removed, improved grade from head to foot of bio-retention area, and drains per design specification.

Trash and Debris

Trash and debris accumulated in the bio-retention area and around the inlet and outlet.

Trash and debris removed from the bio-retention area and disposed of properly.

Sediment

Evidence of accumulated sediment in the basin. Visual evidence of dumping.

Material removed so that there is no clogging or blockage. Material is disposed of properly.

Erosion

Channels have formed around inlets, there are areas of bare soil, or there is other evidence of erosion.

Obstructions and sediment removed so that water flows freely and disperses over a wide area. Obstructions and sediment are disposed of properly.

Vegetation

Vegetation is dead, diseased or overgrown.

Vegetation is healthy and attractive. Grass is maintained at least 3 inches in height.

<u>Condition When Maintenance is Needed</u>	<u>Results When Maintenance is Performed</u>
<i>Mulch</i> Mulch is missing or patchy. Areas of bare earth are exposed or mulch layer is less than 3 inches deep.	All bare earth is covered, except mulch is kept 6 inches away from trunks of trees and shrubs. Mulch is even at a depth of 3 inches.
<i>Inlet/Outlet</i> Sediment accumulations.	Inlet/outlet is clear of sediment and debris and allows water to flow freely.
<i>Miscellaneous</i> Any condition not covered above that needs attention for the bio-retention area to function as designed.	The design specifications are met.

OM-02: Detention Basin

• Detention Basin • Constructed Wetlands • Wet Ponds • Wetlands

This category includes BMPs that are designed to treat storm water by allows pollutants to settle out and gradually release detained storm water through an orifice. Maintenance primarily consists of vegetation management, sediment removal, and mosquito abatement when there is standing water. General conditions when maintenance is needed and the associated maintenance action triggered by those conditions are provided below.

Monthly or as Needed After Storm Event

- Inspect for clogging and that it drains between storms per design specifications.
- Trim vegetation and inspect for woody vegetation.
- Inspect the level of sediment in the forebay.

Bi-Annually

- Evaluate the health of vegetation.
- Remove sediment, litter and debris.
- Inspect the outlet, embankment, dikes, berms, and side slopes for structural integrity and signs of erosion or rodent burrows.
- Inspect outlets and overflow structures for plugging and signs of erosion.
- Check inlets to ensure the piping is intact and not plugged.
- Inspect security measures around the facility.

Annually

- Harvest vegetation during dry periods.

Condition When Maintenance is Needed

Results When Maintenance is Performed

Standing Water

Water stands in the basin between storms and does not drain per design specifications.

Corrected any circumstances that restrict the flow of water from the system and drainage is restored to design condition.

Tree/Brush Growth, Woody Vegetation

Growth does not allow maintenance access or interferes with maintenance activity, dead, diseased, or dying trees.

Trees do not hinder maintenance activities.
Vegetation harvested annually, during dry periods.

Sediment

Accumulated sediment >10% of design basin depth.

Sediment cleaned out to design shape and depth.
Basin reseeded to control erosion, if needed.
Sediment disposed of properly.

<u>Condition When Maintenance is Needed</u>	<u>Results When Maintenance is Performed</u>
<i>Erosion</i>	
Erosion on compacted berm embankment. Rodent burrows on slope.	Cause of erosion is managed appropriately. Side slopes or berm restored to design specifications, as needed. Rodent burrows filled.
<i>Inlet/Outlet</i>	
Piping broken or inlet/outlet blocked.	Piping fixed. Debris/sediment removed and disposed of properly.
<i>Fences/Security Measures</i>	
Fences/security measures broken or missing.	Fences/security measures around facility are secure.
<i>Miscellaneous</i>	
Any condition not covered above that needs attention for the detention basin to function as designed.	The design specifications are met.

OM-03: Green Roof

- Green Roof

Green roofs are designed to reduce storm water runoff volume and improve water quality by intercepting, filtering, absorbing, retaining or detaining storm water. Green roofs consist of the following components: waterproof membrane, drainage layer, vegetated media and vegetation. Regular inspection and maintenance is needed to ensure water flows unimpeded through the green roof and vegetation is healthy. General conditions when maintenance is needed and the associated maintenance action triggered by those conditions are provided below.

Monthly or as Needed After Storm Event

- Inspect media for runoff or wind scouring/exposed underlayment components.
- Inspect for standing water.

Bi-Annually

- Inspect inlet outlet for litter and debris accumulation.
- Inspect vegetation. Prune, weed and remove/replace any dead plants.
- Replenish mulch.

Annually

- Inspect for exposure of liner.
- Inspect for roof leaks.

Condition When Maintenance is Needed

Results When Maintenance is Performed

Standing Water

Roof drainage system is clogged.

There should be no areas of standing water on the green roof. The drainage system is inspected for clogging conditions and repaired or replaced as needed.

Erosion

Areas of scoured media or bare roof.

Green roof media stays in place and does not migrate across or erode from roof surface. Eroded media replaced and re-vegetated. If problem is recurrent, consider media more resistant to wind erosion or installing media retention components.

Leaky Roof

Roof liner has failed.

Evaluate liner for cause of leaks. Repair or replace as necessary.

Miscellaneous

Any condition not covered above that needs attention for the green roof to function as designed.

The design specifications are met.

This page is intentionally left blank.

OM-04: Infiltration Trench/Basin

• Dry Well • Infiltration Basin • Infiltration Trench

This category includes BMPs that are designed to detain storm water by storing it in the void spaces of the aggregate and then infiltrated into the underlying soil. Infiltration trenches/basins are prone to clogging and maintenance consists primarily of preventing sediment buildup and clogging. General conditions when maintenance is needed and the associated maintenance action triggered by those conditions are provided below.

Monthly or as Needed After Storm Event

- Remove obstructions, debris and trash from treatment device and perimeter.
- Check observation well 2 to 3 days after storm to confirm drainage.
- Mow and trim surrounding vegetation.
- Inspect inflow and outflow structures for erosion. Repair as needed.

Annually

- Monitor observation well to confirm that trench is draining properly.
- Inspect the trench for clogging and restore to design conditions, if needed.

Condition When Maintenance is Needed

Results When Maintenance is Performed

Standing Water

Water stands in the infiltration trench between storms and does not drain within 24 hrs after rainfall.

There should be no areas of standing water once inflow has ceased. Any of the following can apply: sediment or trash blockages removed, grade improved, or removed clogging at check dams.

Trash and Debris

Trash and debris accumulated in the infiltration trench and around the inlet and outlet.

Trash and debris removed and disposed of properly.

Sediment

Evidence of accumulated sediment in the infiltration trench.

Material removed so that there is no clogging or blockage. Material is disposed of properly.

Erosion

Channels have formed around inlets, there are areas of bare soil, or there is other evidence of erosion.

Obstructions and sediment removed so that water flows freely and disperses over a wide area. Obstructions and sediment are disposed of properly.

Inlet/Outlet

Sediment accumulations.

Inlet/outlet is clear of sediment and debris and allows water to flow freely.

<u>Condition When Maintenance is Needed</u>	<u>Results When Maintenance is Performed</u>
<i>Surface Materials</i> Material is missing or patchy; areas of bare earth are exposed.	All bare earth is covered, except mulch is kept 6 inches away from trunks of trees and shrubs. Mulch is even at a depth of 3 inches.
<i>Miscellaneous</i> Any condition not covered above that needs attention for the infiltration trench to function as designed.	The design specifications are met.

OM-05: Manufactured Treatment Device

- Hydrodynamic/Vortex Separator
- Other Devices Approved by TAP or NJCAT with a TSS Removal Rate of 80 or more

This category includes manufactured treatment devices. Each BMP is designed differently to treatment storm water and has different maintenance needs. Please refer to the manufacture's requirements for maintenance for more detailed information on inspection and maintenance activities and frequencies. General conditions when maintenance is needed and the associated maintenance action triggered by those conditions are provided below.

Follow manufacture's requirement. Typical maintenance requirements may include:

- Inspect for clogging and standing water.
- Remove accumulated sediment, trash and debris.
- Replace media material, if applicable.

<u>Condition When Maintenance is Needed</u>	<u>Results When Maintenance is Performed</u>
<p><i>Standing Water</i></p> <p>When water stands over the manufactured treatment device between storms and does not drain per design specifications.</p>	<p>There should be no areas of standing water after inflow has ceased Filer drains per design specification. Any of the following could apply: sediment or trash blockage removed, mulch media replaced, and/or overflow pipe flushed/repared in manner that does not cause an illegal discharge.</p>
<p><i>Sediment, Trash, and Debris Accumulation</i></p> <p>Sediment, trash and debris accumulated in the media material, vault, or piping.</p>	<p>Sediment, trash and debris removed and disposed of properly.</p>
<p><i>Mosquitoes</i></p> <p>Evidence of mosquito larvae in treatment unit.</p>	<p>No evidence of mosquito larvae.</p>
<p><i>Miscellaneous</i></p> <p>Any condition not covered above that needs attend in order for the manufactured treatment device to function as designed.</p>	<p>The design specifications are met.</p>

This page is intentionally left blank.

OM-06: Pervious Pavement

- Pervious Concrete • Porous Asphalt • Interlocking Paver Blocks
- Reinforced Turf Grassing/Gravel Filled Grids

This category includes BMPs that are designed to treat storm water by detaining storm water in the void spaces and then infiltrated into the underlying soil. Pervious pavement is prone to clogging and maintenance consists primarily of preventing sediment buildup and clogging. General conditions when maintenance is needed and the associated maintenance action triggered by those conditions are provided below.

Quarterly or as Needed After Storm Event

- Check for sediment and debris accumulation. Prevent soil from washing or flowing onto the pavement. Do not store sand, soil, mulch or other landscaping materials on pervious pavement surfaces.
- Use commercially available regenerative air or vacuum sweeper to remove sediment and debris from the surface.
- Perform vacuum sweeping, power washing, and/or reconstruction to restore surface permeability as needed.
- Inspect for signs of pavement failure. Repair any surface deformations or broken pavers.
- Check for standing water on pavement within 30 minutes following a storm event.
- Inspect underdrain outlets. Remove trash and debris.
- Remove weeds. Mow vegetation in grid pavement (i.e., turf block) as needed.
- Replenish aggregate in joints or grids as needed.

Condition When Maintenance is Needed

Results When Maintenance is Performed

Standing Water

Water stands on the surface of the permeable pavement and 48 hrs has passed since the last rainfall.

There should be no areas of ponded/standing water more than 48 hrs after a rain event. Any of the following can apply: surface swept or vacuumed, underdrains added, underdrains flushed in manner that does not cause an illegal discharge.

Trash and Debris

Leaves, grass clippings, trash, etc., are preventing water from draining into the permeable pavement and are unsightly.

Area is free of all debris and the permeable pavement is draining properly.

Vegetation

Vegetation around the perimeter of the permeable pavement is dead, diseased, or overgrown. Weeds are growing on the surface of the permeable pavement.

Area adjacent to pavement is well-maintained and no bare/exposed areas exist; grass is maintained at a height of 3–6 inches.
No weeds present in the pavement area.

<u>Condition When Maintenance is Needed</u>	<u>Results When Maintenance is Performed</u>
<i>Deteriorating Surface</i> The pavement is cracked; paver blocks are misaligned or have settled.	The surface area is stabilized, exhibiting no signs of cracks or uneven areas in the pavement area.
<i>Miscellaneous</i> Any condition not covered above that needs attention for the pervious pavement to function as designed.	The design specifications are met.

OM-07: Rainwater Harvesting

- Cisterns • Rain Barrels • Vehicle Washing
- Other Non-Potable Water uses Approved by the Building Code

This category includes BMPs that are designed to store water a specific volume of water to use later for irrigation, non-potable water plumbing, vehicle washing, or other non-potable water uses. Maintenance is primarily focused on preventing sediment buildup and clogging, which reduces the capacity of the system. General conditions when maintenance is needed and the associated maintenance action triggered by those conditions are provided below.

Quarterly or as Needed After Storm Event

- Inspect, clean and replace filters and screens, as needed.
- Inspect and clean debris from roof, gutters, downspouts, first flush devices, roof washers, or other collection surfaces.
- Inspect for and repair leaks.
- If rainwater is used for indoor use, inspect and verify that treatment systems are operational and maintaining minimum water quality requirements as determined by DPP or DOH.

<u>Condition When Maintenance is Needed</u>	<u>Results When Maintenance is Performed</u>
<i>Sediment and Debris Accumulation</i>	
Sediment or debris accumulated in filter, screens, gutters, downspouts, first flush device, or roof washers or on roof or other collection surfaces. Sediment accumulated in cistern(s).	Sediment removed. Collection surfaces do not contribute sediment and debris.
<i>Leaks</i>	
Water leaking from system.	No leakage.
<i>Water Quality</i>	
Treatment system is not working properly.	Treatment system is operational and maintaining minimum water quality requirements.
<i>First Flush Diverter</i>	
First flush filter is full or clogged causing permanent flow to the cistern.	First flush is diverted away from the cistern when the first flush diverter valve is removed and cleaned.
<i>Cistern does not Drain within 48 hours</i>	
Outlet is clogged.	Cistern completely drains in less than 48 hrs.
<i>Cistern Drain under 24 hours</i>	
Cistern leaks or outlet allows excessive flows.	Cistern drains in 24 to 48 hrs.
<i>Miscellaneous</i>	
Any condition not covered above that needs attention for the pervious pavement to function as designed.	The design specifications are met.

This page is intentionally left blank.

OM-08: Sand Filter

- Sand Filter

Sand Filters are designed to treat storm water by removing pollutants as the storm water flows through the media. Regular inspection and maintenance is needed to prevent sediment buildup and clogging, which reduces pollutant removal efficiency. General conditions when maintenance is needed and the associated maintenance action triggered by those conditions are provided below.

Monthly or as Needed After Storm Event

- Inspect for standing water, sediment, trash and debris.
- Remove accumulated trash and debris in the unit during routine inspections.

Annually

- Inspect to ensure that the facility is draining completely within five days and per manufacturer's specifications.

Per Manufacturer's Specification

- Replace the media per manufacturer's inspection or as indicated by the condition of the unit.

Condition When Maintenance is Needed

Results When Maintenance is Performed

Standing Water

When water stands over the sand filter media between storms and does not drain within 24 hours after rainfall.

There should be no areas of standing water after inflow has ceased. Any of the following could apply: sediment or trash blockages removed, filter media surface scarified, media replaced underdrains flushed in manner that does not cause an illegal discharge.

Mosquitoes

Evidence of mosquito larvae in treatment unit.

No evidence of mosquito larvae.

Sediment, Trash, and Debris Accumulation

Sediment, trash and debris accumulated in the sand filter unit and around the inlet and outlet.

Sediment, trash, and debris removed so there is no clogging.

Erosion

Channels have formed around inlets, there are areas of bare soil, or there is other evidence of erosion.

Obstructions and sediment removed so that water flows freely and disperses throughout the sand filter media. Obstructions and sediment are disposed of properly.

Inlet/Outlet

Sediment accumulations.

Inlet/outlet is clear of sediment and debris and allows water to flow freely.

Condition When Maintenance is Needed

Results When Maintenance is Performed

Miscellaneous

Any condition not covered above that needs attention for the sand filter to function as designed.

The design specifications are met.

OM-09: Vegetated Biofilter

- Stormwater Curb Extension • Tree Box Filter • Planter Box

This category includes BMPs that are designed to detain and treat runoff without draining into the underlying soil. Maintenance is primarily focused on maintaining healthy vegetation, avoiding clogging and proper functioning of inlets, outlet and high-low bypass. General conditions when maintenance is needed and the associated maintenance action triggered by those conditions are provided below.

Monthly or as Needed After Storm Event

- Inspect bio-filter system, overflow pipe, inlets, and sheet flow areas for clogging and impediments to flow. Repair damaged pipes.
- Remove accumulated sediment, debris, sediment and repair damaged pipes.
- Inspect and repair/replace or replenish splash blocks or rocks, as needed.

Bi-Annually

- Inspect vegetation. Prune, weed and remove/replace any dead plants. Replenish mulch.
- Inspection irrigation system.

Condition When Maintenance is Needed

Results When Maintenance is Performed

Standing Water

Water stands in the vegetated biofilter between storms and does not drain within 24 hrs after rainfall.

There should be no areas of standing water after inflow has ceased. Any of the following could apply: sediment or trash blockages removed, mulch replaced, underdrains flushed in manner that does not cause an illegal discharge.

Trash and Debris

Trash and debris accumulated in and around the inlet and outlet.

Trash and debris removed and disposed of properly.

Sediment

Evidence of accumulated sediment.

Material removed so that there is no clogging or blockage. Material is disposed of properly.

Erosion

Channels have formed around inlets, there are areas of bare soil, or there is other evidence of erosion.

Obstructions and sediment removed so that water flows freely and disperses over a wide area. Obstructions and sediment are disposed of properly.

Vegetation

Vegetation is dead, diseased, or overgrown.

Vegetation is healthy and attractive. Grass is maintained at least 3 inches in height.

<u>Condition When Maintenance is Needed</u>	<u>Results When Maintenance is Performed</u>
<p><i>Mulch</i></p> <p>Mulch is missing or patchy. Areas of bare earth are exposed or mulch layer is less than 3 inches deep.</p>	<p>All bare earth is covered, except mulch is kept 6 inches away from trunks of trees and shrubs. Mulch is even at a depth of 3 inches.</p>
<p><i>Inlet/Outlet</i></p> <p>Sediment accumulations.</p>	<p>Inlet/outlet is clear of sediment and debris and allows water to flow freely.</p>
<p><i>Affected Impervious Areas of Structures</i></p> <p>Obvious effects on surrounding impervious areas or structures.</p>	<p>Hydraulic restriction layers prevent impacts from infiltration to surrounding structures.</p>
<p><i>Miscellaneous</i></p> <p>Any condition not covered above that needs attention for the vegetated bio-filter to function as designed.</p>	<p>The design specifications are met.</p>

OM-10: Vegetated Swale/Strip

• Dry Swale • Vegetated Buffer Strip • Vegetated Swale

This category includes BMPs that are designed to provide to remove pollutants by physically straining and filtering water through vegetation or cobble within the swale/strip. Maintenance is primarily focused on maintaining healthy vegetation and avoiding clogging. General conditions when maintenance is needed and the associated maintenance action triggered by those conditions are provided below.

Monthly or as Needed After Storm Event

- Inspect swale/strip for ponding.
- Inspect inlets and sheet flow areas for impediments.
- Remove accumulated sediment, litter and debris.

Bi-Annually

- Inspect vegetation. Prune, mow, weed and remove/replace any dead plants.
- Replenish mulch.
- Inspection irrigation system.

Condition When Maintenance is Needed

Results When Maintenance is Performed

Standing Water

Water stands in the vegetated swale/strip between storms and does not drain within 24 hrs after rainfall.

There should be no areas of standing water once inflow has ceased. Any of the following could apply: improved grading or underdrains flushed in manner that does not cause an illegal discharge.

Sediment, Trash, and Debris Accumulation

Sediment, trash and debris accumulated in the swale and around the inlet and outlet.

Material removed so that there is no clogging or blockage. Sediment deposits removed without significant disturbance of the vegetation.

Erosion

Channels have formed around inlets, there are areas of bare soil, or there is other evidence of erosion.

No erosion or scouring evident. Damaged areas repaired with crushed gravel. Over time grass will start to cover over rock.

Vegetation

Vegetation is dead, diseased, or overgrown.

Vegetation is healthy and attractive. Grass is maintained at least 3 inches in height.

Mulch (if used)

Mulch is missing or patchy. Areas of bare earth are exposed or mulch layer is less than 3 inches deep.

All bare earth is covered, except mulch is kept 6 inches away from trunks of trees and shrubs. Mulch is even at a depth of 3 inches.

Inlet/Outlet

Sediment or debris accumulations.

Inlet/outlet is clear of sediment and debris and allows water to flow freely.

<u>Condition When Maintenance is Needed</u>	<u>Results When Maintenance is Performed</u>
<i>Flow Spreader (if applicable)</i>	
Flow spreader uneven or clogged so that flows are not uniformly distributed through entire swale width.	Spreader leveled and cleaned such that flows are distributed evenly over the entire swale width.
<i>Visual Contaminants and Pollution</i>	
Visual evidence of oil, gasoline, contaminants, or other pollutants.	No visual evidence of contaminants or pollutants present.
<i>Miscellaneous</i>	
Any condition not covered above that needs attention for the vegetated swale/strip to function as designed.	The design specifications are met.