



**CITY AND COUNTY OF HONOLULU
STORM WATER BEST MANAGEMENT PRACTICE
MANUAL**

CONSTRUCTION

FINAL

November 2011

**By:
City and County of Honolulu
Department of Environmental Services
Kapolei, Hawaii**



TABLE OF CONTENTS

TABLE OF CONTENTS	i
LIST OF FIGURES	iii
LIST OF TABLES	iv
LIST OF ACRONYMS	v
ACKNOWLEDGEMENTS	viii
LIST OF FACT SHEETS	ix
SIGNIFICANT ADDITIONS AND REVISIONS MADE FROM 2003 CASQA CONSTRUCTION BMP HANDBOOK	xi
SECTION 1: INTRODUCTION	1-1
1.1 MANUAL PURPOSE AND SCOPE	1-1
1.1.1 <i>Users of the Manual</i>	1-2
1.1.2 <i>Organization of the Manual</i>	1-2
1.1.3 <i>Relationships to Other Manuals</i>	1-3
1.2 CONSTRUCTION SITES AND THEIR IMPACTS ON WATER QUALITY.....	1-4
1.2.1 <i>Pollutants Associated with Construction Activities</i>	1-4
1.2.2 <i>Erosion and Sedimentation</i>	1-5
1.2.3 <i>Other Pollutants</i>	1-7
1.2.4 <i>Impacts of Erosion and Sedimentation, and Other Pollutants</i>	1-8
1.3 REGULATORY PROGRAM.....	1-9
1.3.1 <i>Federal NPDES Program</i>	1-9
1.3.2 <i>State NPDES Programs</i>	1-10
1.3.3 <i>Municipal NPDES Programs</i>	1-12
1.4 DEFINITIONS	1-12
1.5 REFERENCE.....	1-13
SECTION 2: SITE-SPECIFIC CONSTRUCTION BMP PLAN (SSBMPP)	2-1
2.1 ASSESS CONSTRUCTION SITE AND PLANNED ACTIVITIES	2-2
2.1.1 <i>Contractor Activities</i>	2-2
2.1.2 <i>Disturbed Areas and Erosion Potential</i>	2-2
2.1.3 <i>Site History</i>	2-2
2.2 IDENTIFY AND SELECT BMPs	2-2
2.2.1 <i>Define BMP Objectives</i>	2-3
2.2.2 <i>Identify BMP Categories</i>	2-4
2.2.3 <i>Select BMPs</i>	2-4
2.3 SITE INSPECTIONS	2-5
2.4 BMP MONITORING	2-5

2.5	BMP MAINTENANCE	2-6
2.6	STORM WATER POLLUTION CONTROL DOCUMENTATION	2-7
SECTION 3: EROSION AND SEDIMENT CONTROL BMPS		3-1
3.1	EROSION CONTROL	3-1
3.2	SEDIMENT CONTROL	3-2
3.3	WIND EROSION CONTROL	3-3
3.4	TRACKING CONTROL BMPS	3-4
3.5	EROSION AND SEDIMENT CONTROL BMP FACT SHEET FORMAT	3-4
3.6	BMP FACT SHEETS AND OBJECTIVES	3-4
3.7	EROSION CONTROL FACT SHEETS	EC-1
3.8	SEDIMENT CONTROL FACT SHEETS	SE-1
3.9	WIND EROSION CONTROL FACT SHEETS	WE-1
3.10	TRACKING CONTROL FACT SHEETS	TC-1
SECTION 4: NON-STORM WATER MANAGEMENT AND MATERIAL MANAGEMENT BMPS		4-1
4.1	NON-STORM WATER MANAGEMENT BMPS	4-1
4.2	WASTE MANAGEMENT & MATERIALS POLLUTION CONTROL BMPS	4-2
4.3	FACT SHEET FORMAT	4-3
4.4	BMP FACT SHEETS	4-3
4.5	NON-STORM WATER MANAGEMENT FACT SHEETS	NS-1
4.6	WASTE MANAGEMENT AND MATERIALS POLLUTION CONTROL FACT SHEETS	WM-1
SECTION 5: GLOSSARY		5-1

LIST OF FIGURES

Figure 1-1: Honolulu Storm Water BMP Manual - Construction	1-2
Figure 1-2: Project Lifecycle	1-3
Figure 3-1: Example Fact Sheet.....	3-4
Figure 4-1: Example of Fact Sheet	4-3

LIST OF TABLES

Table 1-1: Pollutant Impact on Water Quality.....	1-4
Table 1-2: Example of Dust Sources at Construction Sites.....	1-7
Table 1-3: Other Construction Activity Pollutants	1-8
Table 3-1: Erosion Control BMPs	3-1
Table 3-2: Temporary Sediment Control BMPs.....	3-2
Table 3-3: Wind Erosion Control BMPs	3-3
Table 3-4: Temporary Tracking Control BMPs.....	3-4
Table 3-5: Erosion, Sediment, Wind and Tracking Control and BMP Objectives.....	3-5
Table 4-1: Non-Storm Water Management BMP.....	4-1
Table 4-2: Waste Management & Materials Pollution Control BMP.....	4-2
Table 4-3: Quick Reference – Disposal Alternatives	4-3

LIST OF ACRONYMS

AASHTO	American Association of State Highway and Transportation Officials
AC	Asphalt Concrete
ADL	Aerially Deposited Lead
ANSI	American National Standards Institute
APHA	American Public Health Association
APWA	American Public Works Association
ASTM	American Society for Testing Materials
AWWA	American Water Works Association
BAT	Best Available Technology (economically available)
BCT	Best Conventional Technology (pollution control)
BFP	Bonded Fiber Matrix
BMPs	Best Management Practices
BOD	Biological Oxygen Demand
C&D	Construction and Demolition
CA	Contractor Activities
CASQA	California Stormwater Quality Association
CCS	Cellular Confinement System
CCH or City	City and County of Honolulu
CERCLA	Comprehensive Environmental Response Compensation and Liability Act
CFR	Code of Federal Register
COE or CORPS	United States Army Corporation of Engineers
CPI	Coalescing Plate Interceptor
CWA	Clean Water Act (Federal Water Pollution Control Act of 1972 as amended in 1987)
CWB	DOH, Environmental Services - Clean Water Branch
DDC	CCH, Department of Design and Construction
DLNR	State of Hawaii, Department of Land and Natural Resources
DOH	State of Hawaii, Department of Health
DTS	CCH, Department of Transportation Services
DPP	CCH, Department of Planning and Permitting
EC	Erosion Control BMP
EIR	Environmental Impact Report
EMC	Event Mean Concentration
ENV	CCH, Department of Environmental Services
EOS	Equivalent Opening Size

ESA	Environmentally Sensitive Area
ESCM	Erosion and Sedimentation Control Measures
FEMA	Federal Emergency Management Agency
FHWA	Federal Highway Administration
GIS	Geographical Information System
H:V	Horizontal to Vertical Ratio
HAR	Hawaii Administrative Rules
HAR 11-55	HAR, Title 11, Chapter 55
Hazmat	Hazardous Material
HAZWOPER	Hazardous Waste Operations and Emergency Response
HDOA	State of Hawaii, Department of Agriculture
HDPE	high density polyethylene
HED	CORP, Honolulu Engineering District
HIOSH	Hawaii Occupational Safety and Health
HSG	Hydrologic Soil Groups
HWYs	DOT-Highways Division
IPM	Integrated Pest Management
MEP	Maximum Extent Practicable
MS4	Municipal Separate Storm Sewer System
MSDS	Material Safety Data Sheet
NGPC	Notice of General Permit Coverage
NOAA	National Oceanographic and Atmospheric Administration
NOC	Notice of Cessation
NOEC	no observed effects concentration
NOI	Notice of Intent
NPDES	National Pollutant Discharge Elimination System
NPS	Nonpoint Source
NRC	National Response Center
NRCS	Natural Resources Conservation Service
NS	Non-Storm Water Management BMP
NSF	National Science Foundation
NURP	National Urban Runoff Program
O&G	Oil and Grease
O&M	Operations and Maintenance
OSDS	Onsite disposal system
OSHA	Occupational Safety and Health Administration
OSWM	DOH, Office of Solid Waste Management
P2	Pollution Prevention

PAHs	Polyaromatic Hydrocarbons
PAM	Polyacrylamide
PCC	Portland Concrete Cement
PCS	petroleum-contained soil
PLS	Pure Live Seed
PPT	Pollution Prevention Team
POTW	Publicly Owned Treatment Works
PSD	Particle Size Distribution
RCRA	Resource Conservation and Recovery Act
RECPs	rolled erosion control products
SAP	Sampling and Analysis Plan
SARA	Superfund Amendments and Reauthorization Act
SC	Sediment Control BMP
SIC	Standard Industrial Classification
SID	Slope Interruption Device
SPCC	Spill Prevention Control and Countermeasure
SSBMPP	Site-Specific Construction BMP Plan
SWMP	Storm Water Management Program
SWQ	ENV, Storm Water Quality Branch
TMDL	Total Maximum Daily Load
TOC	Total Organic Carbon
TR	Tracking Control BMP
TSS	Total Suspended Solids
UFC	Uniform Fire Code
USACE	United States Army Corps of Engineers
USDA	United States Department of Agriculture
USDOT	United States Department of Transportation
USEPA	United States Environmental Protection Agency
WE	Wind Erosion Control BMP
WEF	Water Environment Federation
WM	Waste Management and Materials Pollution Control BMP

ACKNOWLEDGEMENTS

This City and County of Honolulu (CCH or City) Best Management Practices (BMP) manual is based upon the California Stormwater Quality Association (CASQA) Stormwater Best Management Practice Handbooks (2003). These handbooks were originally published in 1993 by the California Stormwater Quality Task Force (SWQTF), the predecessor of CASQA. This manual also includes selected BMPs from the State of Hawaii Department of Transportation (DOT), Highways Division (HWYs), Construction BMP Field Handbook (2006).

Disclaimer

Information contained in CASQA products and this manual is to be considered general guidance and is not to be construed as specific recommendations for specific cases. Users of this manual assume all liability directly or indirectly arising from use of this manual. The mention of commercial products, their source, or their use in connection with information in CASQA and this manual is not to be construed as an actual or implied endorsement, recommendation, or warranty of such product. This disclaimer is applicable whether information from the CASQA products and this manual is obtained in hard copy form or downloaded from the Internet.

Technical Contributions

The development of CCH Storm Water BMP Manual - Construction was guided by technical contributions from representatives of regulatory agencies (water quality and health), industry, transportation, and consulting. The quality of this manual is a result of the diverse expertise and experience of the technical contributors.

Frederick Berg, Hawaii Developer's Council

Jeremy Kimura, State of Hawaii, Department of Land and Natural Resources (DLNR)
Engineering Division

Russell Leong, US Army Corps of Engineers (COE or CORP), Honolulu Engineering District
(HED)

Curtis Masuda, DOT-HWYs

Reef Migita and Joanna Seto, Department of Health (DOH), Clean Water Branch (CWB)

LIST OF FACT SHEETS

Erosion Control (EC) Fact Sheets

EC-0 Employee/Subcontractor Training
EC-1 Scheduling
EC-2 Preservation of Existing Vegetation
EC-3 Hydraulic Mulch
EC-4 Hydroseeding
EC-5 Soil Binders
EC-7 Geotextiles and Mats
EC-8 Wood Mulching
EC-9 Earth Dikes and Drainage Swales
EC-10 Velocity Dissipation Devices
EC-11 Slope Drains
EC-12 Streambank Stabilization
EC-14 Seeding, Planting and Sodding
EC-15 Slope Roughening/Terracing
EC-16 Topsoil Management

Sediment Control (SE) Fact Sheets

SE-1 Silt Fence
SE-2 Sediment Basin
SE-3 Sediment Trap
SE-4 Check Dams
SE-5 Fiber Rolls
SE-6 Gravel Bag Berm
SE-7 Street Sweeping and Vacuuming
SE-8 Sandbag Barrier
SE-10 Storm Drain Inlet Protection
SE-11 Chemical Treatment
SE-12 Location of Potential Sources of Sediment
SE-13 Level Spreader
SE-14 Rip-Rap & Gabion Inflow Protection
SE-15 Vegetated Buffer Strips and Channels
SE-16 Compost Socks and Berms

Wind Erosion Control (WE) Fact Sheets

WE-1 Wind Erosion Control

Tracking Control (TR) Fact Sheets

TR-1 Stabilized Construction Entrance/Exit
TR-2 Stabilized Construction Roadway
TR-3 Entrance/Outlet Tire Wash

Non-Storm Water Management (NS) Fact Sheets

- NS-1 Water Conservation Practices
- NS-2 Dewatering Operations
- NS-3 Paving and Grinding Operations
- NS-4 Temporary Stream Crossing
- NS-5 Clear Water Diversion
- NS-6 Illicit Connection/Discharge
- NS-7 Potable Water/Irrigation
- NS-8 Vehicle and Equipment Cleaning
- NS-9 Vehicle and Equipment Fueling
- NS-10 Vehicle and Equipment Maintenance
- NS-11 Pile Driving Operations
- NS-12 Concrete Curing
- NS-13 Concrete Finishing
- NS-14 Material over Water
- NS-15 Demolition Adjacent to Water
- NS-16 Temporary Batch Plants

Waste Management (WM) and Materials Pollution Control Fact Sheets

- WM-1 Material Delivery and Storage
- WM-2 Material Use
- WM-3 Stockpile Management
- WM-4 Spill Prevention and Control
- WM-5 Solid Waste Management
- WM-6 Hazardous Waste Management
- WM-7 Contaminated Soil Management
- WM-8 Concrete Waste Management
- WM-9 Sanitary/Septic Waste Management
- WM-10 Liquid Waste Management

SIGNIFICANT ADDITIONS AND REVISIONS MADE FROM 2003 CASQA CONSTRUCTION BMP HANDBOOK

Many additions and revisions were made to the contents of CASQA Stormwater Best Management Practice Handbook Construction, January 2003, in order to be used for this City and County of Honolulu Storm Water Best Management Practices Manual. General changes include the following:

- An updated list of acronyms with local definitions and terms.
- Specific references to State of California, Regional Water Control Board, counties, and cities regulatory framework have been changed to applicable State of Hawaii and CCH references throughout the drafted document.
- Section 2, Site Specific Construction BMP Plan (SSBMPP), references current DOH CWB, Hawaii Administrative Rules (HAR) Title 11, Chapter 55, Water Pollution Control Appendix C NPDES General Permit Authorizing Discharges of Storm Water Associated with Construction Activity.
- A caveat has been inserted wherever estimated unit prices and costs are given. The unit prices and costs in this Manual reflect California's unit prices from the 1990's to 2003. Since then, unit prices have escalated significantly and costs in Hawaii are generally higher when compared to California.
- CASQA BMP fact sheet numerical indexes have changed due to additions and deletions of BMP fact sheets.
- In addition to CASQA BMPs, fact sheet information was also taken from the current CCH BMP Manual for Construction Sites in Honolulu, dated May 1999.

<i>EC-0 Employee/ Subcontractor Training</i>	<i>EC-0 is based on CA40 Employee Training (pp. 1-31 to 1-32). Employee/Subcontractor Training was inserted to ensure that the purposes of the BMPs and the basics of storm water management are clear to all those involved. The emphasis on employee/subcontractor training is a necessity to optimize the effects of the BMPs. Proper training will lead to correct identification and usage of the BMPs and will also promote more active employee/subcontractor involvement.</i>
<i>EC-15 Slope Roughening/ Terracing</i>	<i>EC-15 has been edited from highway design grading, and replaced with City ROH Section 14-14 and subdivision rules for grading and ESC42 Slope Roughening/Terracing (pp. 2-63 to 2-65). Slope Roughening/Terracing provides small depression for trapping sediment and aid in establishment of vegetation. BMP methods relating to vegetation should be strongly encouraged to take advantage of Hawaii's constant, tropical weather.</i>

<i>SE-12 Location of Potential Sources of Sediment</i>	<i>SE-12 is based on ESC3 Location of Potential Sources of Sediment (pp. 2-10 to 2-11). Identifying the sources of sediment and erosion will prevent future problems. It is more economically efficient to prevent sedimentation and erosion than it is to address the long term damages.</i>
<i>WM-5 Solid Waste Management</i>	<i>WM-5 references CA20 Solid Waste Management (pp. 1-15 to 1-18). Information regarding inert fill material and recycling from section CA20 has been added. Inert fill is frequently generated in construction sites therefore it is important to note how it should be properly disposed. Encouraging recycling and reuse help to reduce trash and preserve the environment.</i>

- Fact sheet information was taken from DOT-HWYs Construction BMP Field Manual, September 2006, for the following revised sections:

<i>EC-14 Seeding, Planting and Sodding</i>	<i>EC-14 is based on DOT EC-4 Seeding and Planting with additional information on sodding from EPA NPDES General Permit for Stormwater Discharge Requirements for Small and Large Construction Activities, 2008. Seeding, Planting and Sodding stabilize soil by covering the surface with vegetation, which also creates aesthetic value to the area. These methods immediately and efficiently assist infiltration. Seeding, planting and sodding are encouraged since they are especially effective in Hawaii's favorable weather.</i>
<i>EC-16 Topsoil Management</i>	<i>EC-16 is based on DOT SM-21 Top Soil Management. Topsoil management not only helps with the revegetation efforts, but through the reapplication of native topsoil it also plays a large role in reestablishing native vegetation. An initiative needs to be taken to preserve native Hawaiian plants, and thus EC-16 is a very applicable BMP fact sheet for CCH BMP Manual.</i>
<i>SE-13 Level Spreader</i>	<i>SE-13 is based on DOT SC-10 Level Spreader. Level spreaders condense the time needed for concentrated flows to settle and thus prevent erosion. The warm climate in Hawaii increases the effectiveness of this method and accelerates the settlement process even more.</i>
<i>SE-14 Rip-Rap and Gabion Inflow Protection</i>	<i>SE-14 is based on DOT SC-3 Rip-Rap and Gabion Inflow Protection. Rip-Rap & Gabion line drainageways and stabilize the flow channel along steep slopes. This BMP method can be applied to steep sloped worksites on the islands.</i>
<i>SE-15 Vegetated Buffer Strips and Channels</i>	<i>SE-15 is based on DOT SC-5 Vegetated Filter Strips and Buffers. Vegetated buffer strips and channels protect soil from erosion, increase infiltration, and remove sediment from surface runoff. It is an economical approach in Hawaii since the constant weather fosters the growth of vegetation.</i>

- CASQA references to sizing of the sedimentation basins were replaced with current CCH Rules for Soil Erosion Standards and Guidelines, dated April 1999. References to current rules are forthcoming.
- SE-1 Silt Fence was revised to allow metal stakes and not only wooden stakes. New callouts were inserted for geotextile fabric length and stake lengths.
- SE-2 Sediment Basin was revised to match current City and DOH CWB sizing criteria.
- SE-7 Street Sweeping and Vacuuming was replaced with local references.
- Deleted CASQA EC-6 Straw Mulch, EC-12 Polyacrylamide and SE-9 Straw Bale Barrier.
- Table 4-3 Quick Reference- Disposal Alternatives was added to the narrative part of Section 4. This table is from CA40 Employee/Subcontractor Training (pp. 1-33 to 1-39) of the City BMP Manual (May 1999).
- NS-2 Dewatering Operations was updated to reference DOH CWB requirements and a new Figure 1 Dewatering Permit Flow Chart was added.
- In WM-2 Material Use, sections from City BMP CA3 Structure Construction and Painting were added.
- In WM-3 Stockpile Management, sections from City ESC-25 Protection of Stockpiles were added.
- In section WM-7 Contaminated Soil Management, sections from City CA-22 Contaminated Soil Management were added.
- A few figures were updated to match BMP fact sheet narratives.
- For construction BMPs diverting runoff away from construction sites, hydraulic capacity is based upon a peak flow from a design 10-year, 1-hour storm to comply with Plate 1 in CCH - Department of Planning and Permitting (DPP) “Rules Relating to Storm Drainage Standards” in the following Fact Sheets:
 - EC-9 Earth Dikes and Drainage Swales,
 - EC-10 Velocity Dissipation Devices,
 - EC-11 Slope Drains,
 - SE-4 Check Dams, and
 - SE-11 Chemical Treatment.
- For construction BMPs within construction sites, hydraulic capacity is based upon a peak flow from a design 2-year, 1-hour storm in the following Fact Sheets:
 - SE-11 Chemical Treatment.
- In the originally released version of the Construction BMP Manual (July 2011) each Fact Sheets’ primary and secondary objectives were represented with check marks for both. In this updated version (November 2011) the primary objectives are represented by check marks and secondary objectives are represented by triangles on each Fact Sheet.

SECTION 1: INTRODUCTION

Note: Information contained in the Storm Water Best Management Practice (BMP) Manual is to be considered general guidance and is not to be construed as specific recommendations for specific cases. Users of the manuals assume all liability directly or indirectly arising from use of the products. Please refer to the Disclaimer in Acknowledgements.

Storm water runoff is part of the natural hydrologic process. However, human activities such as urbanization and construction can impact storm water runoff. Construction activities can alter natural drainage patterns and affect runoff water quality, adding pollutants to rivers, lakes, and streams as well as coastal bays and estuaries, and ultimately, the ocean. Urban runoff is a significant source of water pollution, causing possible declines in fisheries, restrictions on swimming, and limiting our ability to enjoy many of the other benefits that water resources provide (United States Environmental Protection Agency [USEPA], 1992). Urban runoff in this context includes all flows discharged from urban land uses into storm water conveyance systems and receiving waters and includes both dry weather non-storm water sources (e.g., runoff from landscape irrigation, etc.) and wet weather storm water runoff. In this manual, urban runoff and storm water runoff are used interchangeably.

For many years, the effort to control the discharge of storm water focused on quantity (e.g., drainage, flood control) and, to a limited extent, on quality of the storm water (e.g., sediment and erosion control). However, in recent years awareness of the need to improve water quality has increased. With this awareness Federal, State, and City programs have been established to pursue the ultimate goal of reducing pollutants contained in storm water discharges to our waterways. The emphasis of these programs is to promote the concept and the practice of preventing pollution at the source, before it can cause environmental problems (USEPA, 1992). However, where further controls are needed, treatment of polluted runoff may be required.

1.1 MANUAL PURPOSE AND SCOPE

The purpose of this manual is to provide general guidance for selecting and implementing BMPs that will eliminate or reduce the discharge of pollutants from construction sites to waters of the State. This manual also provides guidance on developing and implementing site-specific construction BMP plans (SSBMPP) that document the selection and implementation of BMPs for a particular construction project.

Even though minimum construction BMPs will be required in the revised Rules Relating to Soil Erosion Standards and Guidelines, this manual is to provide general guidance, such that a design engineer will need to exercise professional judgment to BMP design and application.

This manual provides the framework for an informed selection of BMPs, and development and implementation of a SSBMPP. However, due to the diversity in climate, receiving waters, and construction site conditions, this manual does not dictate the use of specific BMPs and therefore cannot guarantee compliance with National Pollutant Discharge Elimination System (NPDES) permit requirements or CCH requirements specific to the user's site.

1.1.1 *Users of the Manual*

This manual provides guidance suitable for use by a wide range of individuals involved in construction site water pollution control. Each user of the manual is responsible for working within their capabilities obtained through training and experience, and for seeking the advice and consultation of appropriate experts at all times.

The target audience for this manual includes: developers, including their planners and engineers; contractors, including their engineers, estimators, superintendents, foremen, tradesmen, and subcontractors; municipal agencies, including their engineers, municipal inspectors, building inspectors, permit counter staff, code enforcement officers, and construction staff; regulatory agencies, including permit staff and enforcement staff, and the general public with an interest in storm water pollution control.

1.1.2 *Organization of the Manual*

The manual is organized to assist the user in developing and implementing a storm water program for construction sites to reduce potential impacts to both storm water and non-storm water discharges on receiving waters. Sections of this manual are displayed in Figure 1-1.

Figure 1-1: Honolulu Storm Water BMP Manual - Construction

<p style="text-align: center;">Section 1 Introduction</p> <p><i>This section provides a general review of the sources and impacts of construction activity storm water discharges and provides an overview of the federal, state, and CCH programs regulating storm water discharges.</i></p>	<p style="text-align: center;">Section 2 Site-Specific BMPs Plan</p> <p><i>This section navigates through the construction activities storm water permit. It covers minimum requirements, construction activity assessment, and BMP selection.</i></p>	<p style="text-align: center;">Section 3 Erosion and Sediment Control BMPs</p> <p><i>This section provides an overview of BMPs for erosion, sediment, wind, and tracking control.</i></p>
<p style="text-align: center;">Section 4 Non-Storm Water Management and Material Management BMPs</p> <p><i>This section provides an overview of BMPs for non-storm water management and materials management including waste materials.</i></p>	<p style="text-align: center;">Section 5 Glossary</p> <p><i>This section identifies terms used in the BMP manuals.</i></p>	

1.1.3 Relationships to Other Manuals

This manual is one of three manuals. Collectively, the three manuals address BMP selection throughout the life of a project – from planning and design – through construction – and into operation and maintenance, shown in Figure 1-2. Individually, each manual is geared to a specific target audience during each stage of a project. This manual, the Construction Manual, addresses selection and implementation of BMPs to eliminate or to reduce the discharge of pollutants associated with construction activity. The remaining two manuals are under development and are planned to be released concurrently with this manual. Readers are encouraged to refer to the CASQA Handbooks for guidance. The CASQA Handbooks are available online at www.cabmphandbooks.com.

Figure 1-2: Project Lifecycle

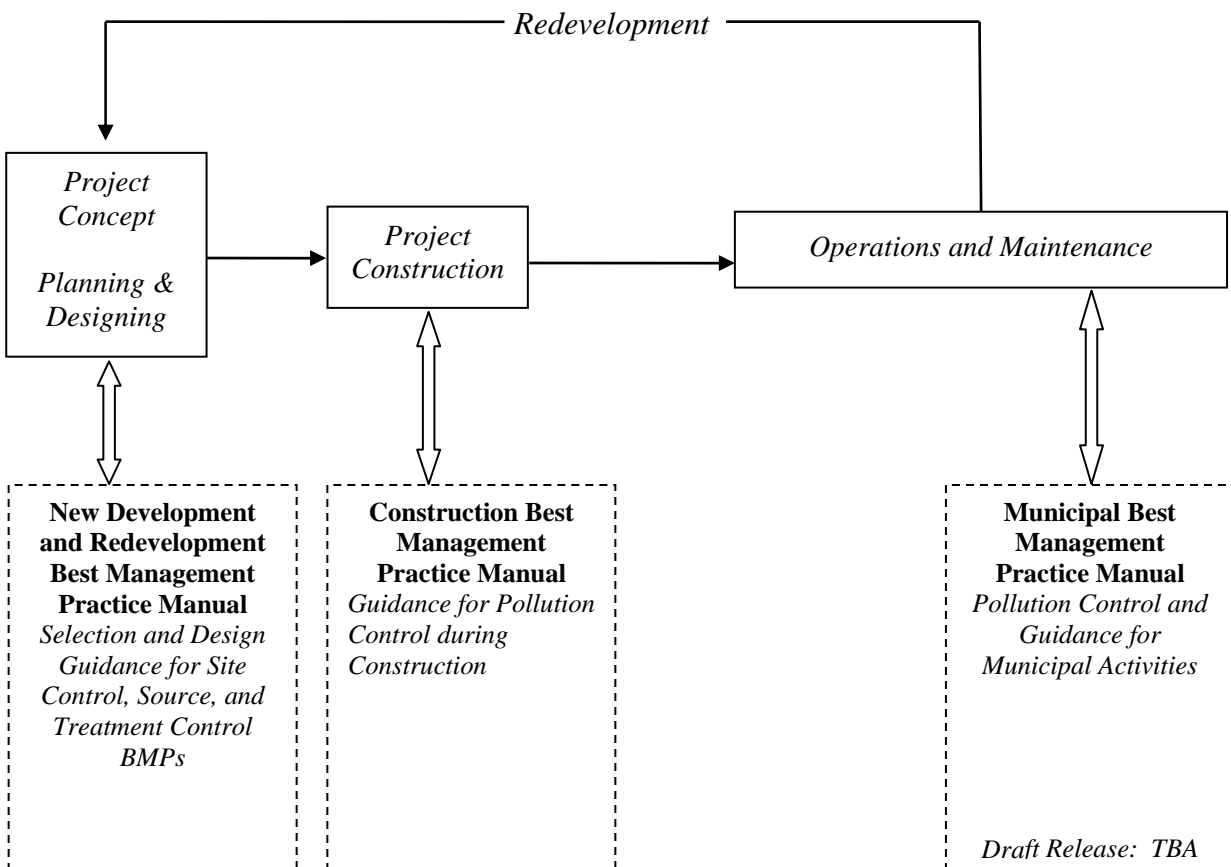

For a comprehensive understanding of storm water pollution control throughout the lifecycle of the project, it is recommended that the reader obtain and become familiar with all three manuals. Typically, municipal storm water program managers, regulators, environmental organizations, and storm water quality professionals will have an interest in all three manuals. For a focused understanding of storm water pollution control during a single phase of the project lifecycle, a reader may obtain and become familiar with the manual associated with the appropriate phase. Typically, contractors, construction inspectors, some regulators, and some City staff may have an interest in a single manual.

1.2 CONSTRUCTION SITES AND THEIR IMPACTS ON WATER QUALITY

1.2.1 *Pollutants Associated with Construction Activities*

Storm water runoff naturally contains numerous constituents. However, urbanized and urban activities such as construction increase constituent concentrations to levels that impact water quality. Pollutants associated with storm water include sediment, nutrients, bacteria and viruses, oil and grease, metals, organics, pesticides, gross pollutants (floatables), and miscellaneous waste. Some constituents can also affect the pH of storm water. Storm water runoff can also be highly attractive to vector organisms, particularly mosquitoes, which can impact public health and become a legal liability. Storm water pollutants are described in Table 1-1.

Excessive erosion and sedimentation are perhaps the most visible water quality impacts due to construction activities. Other less visible impacts are associated with off-site discharge of pollutants such as metals, nutrients, soil additives, pesticides, construction chemicals, and other construction waste. The magnitude of storm water impacts depends on construction activities, climatic conditions, and site conditions. Development of a comprehensive site-specific BMPs plan requires a basic understanding of the impacts, pollutant sources and other contributing factors, as well as BMPs to eliminate or reduce these impacts.

Table 1-1: Pollutant Impact on Water Quality

Sediment	Sediment is a common component of storm water, and can be a pollutant. Sediment can be detrimental to aquatic life (primary producers, benthic invertebrates, coral reefs and fish) by interfering with photosynthesis, respiration, growth, reproduction, and oxygen exchange in water bodies. Sediment can transport other pollutants that are attached to it including nutrients, trace metals, and hydrocarbons. Sediment is the primary component of total suspended solids (TSS), a common water quality analytical parameter.
Nutrients	Nutrients including nitrogen and phosphorous are the major plant nutrients used for fertilizing landscapes, and are often found in storm water. These nutrients can result in excessive or accelerated growth of vegetation, such as algae, resulting in impaired use of water in lakes and other sources of water supply. For example, nutrients have led to a loss of water clarity in Lake Wilson. In addition, un-ionized ammonia (one of the nitrogen forms) can be toxic to fish.
Bacteria and viruses	Bacteria and viruses are common contaminants of storm water. For separate storm drain systems, sources of these contaminants include animal excrement and sanitary sewer overflow. High levels of indicator bacteria in storm water have led to the closure of beaches, lakes, and rivers to contact recreation such as swimming.
Oil and Grease	Oil and grease includes a wide array of hydrocarbon compounds, some of which are toxic to aquatic organisms at low concentrations. Sources of oil and grease include leakage, spills, cleaning and sloughing associated with vehicle and equipment engines and suspensions, leaking and breaks in hydraulic systems, restaurants, and waste oil disposal.

Metals	Metals including lead, zinc, cadmium, copper, chromium, and nickel are commonly found in storm water. Many of the artificial surfaces of the urban environment (e.g., galvanized metal, paint, automobiles, or preserved wood) contain metals, which enter storm water as the surfaces corrode, flake, dissolve, decay, or leach. Over half the trace metal load carried in storm water is associated with sediments. Metals are of concern because they are toxic to aquatic organisms, can bioaccumulate (accumulate to toxic levels in aquatic animals such as fish), and have the potential to contaminate drinking water supplies.
Organics	Organics may be found in storm water in low concentrations. Often synthetic organic compounds (adhesives, cleaners, sealants, solvents, etc.) are widely applied and may be improperly stored and disposed. In addition, deliberate dumping of these chemicals into storm drains and inlets causes environmental harm to waterways.
Pesticides	Pesticides (including herbicides, fungicides, rodenticides, and insecticides) have been repeatedly detected in storm water at toxic levels, even when pesticides have been applied in accordance with label instructions. As pesticide use has increased, so too have concerns about adverse effects of pesticides on the environment and human health. Accumulation of these compounds in simple aquatic organisms, such as plankton, provides an avenue for biomagnification through the food web, potentially resulting in elevated levels of toxins in organisms that feed on them, such as fish and birds.
Gross Pollutants	Gross Pollutants (trash, debris, and floatables) may include heavy metals, pesticides, and bacteria in storm water. Typically resulting from an urban environment, industrial sites and construction sites, trash and floatables may create an aesthetic “eye sore” in waterways. Gross pollutants also include plant debris (such as leaves and lawn-clippings from landscape maintenance), animal excrement, street litter, and other organic matter. Such substances may harbor bacteria, viruses, vectors, and depress the dissolved oxygen levels in streams, lakes, and estuaries sometimes causing fish kills.
Vector Production	Vector production (e.g., mosquitoes, flies, and rodents) is frequently associated with sheltered habitats and standing water. Unless designed and maintained properly, standing water may occur in treatment control BMPs for 72 hours or more, thus providing a source for vector habitat and reproduction (Metzger, 2002).

1.2.2 *Erosion and Sedimentation*

Soil erosion is the process by which soil particles are removed from the land surface by wind, water, or gravity. Most natural erosion occurs at slow rates; however, the rate of erosion increases when land is cleared or altered and left unprotected. Construction sites, if unprotected, can erode at rates in excess of one hundred times the natural background rate of erosion.

Sediment resulting from excessive erosion is a pollutant. Sedimentation is defined as the settling out of particles transported by water. Sedimentation occurs when the velocity of water is slowed sufficiently to allow suspended soil particles to settle. Larger particles, such as gravel and sand, settle more rapidly than fine particles such as silt and clay. Effective sediment control begins with proper erosion control, which minimizes the availability of particles for settling downstream.

Erosion from Rainfall Impact

The impact of raindrops on bare soil can cause erosion. On undisturbed soil protected by vegetation or other cover, the erosion is minimal. Construction activities increase the amount of exposed and disturbed soil, which increases erosion potential from rainfall.

Sheet Erosion

After rainfall strikes the ground, it flows in a thin layer for a short distance. The distance of sheet flow depends on slope, soil roughness, type of vegetative cover, and rainfall intensity. Erosion due to sheet flow on undisturbed soils is minimal but on soils disturbed by construction it is greater. However, sheet flows are capable of transporting soil particles dislodged by the impact of raindrops onto bare soil, and thus cannot be ignored. Sheet flow cannot be maintained for long distances. In general, sheet flow will tend to concentrate into rill flows within 300 to 400 ft.

Rill and Gully Erosion

As runoff accumulates, it concentrates in rivulets that cut grooves (rills) into the soil surface. Rills generally run parallel to one another and to the slope of the soil surface, if left unchecked, several rills may join together to form a gully. Rills are small enough to be stepped across, whereas a gully requires added effort to be traversed. The rate of rill erosion can easily be one hundred times greater than that of sheet flow, and the rate of gully erosion can easily be one hundred times greater than rill erosion. Due to the significant amount of sediment generated by rill and gully erosion, these types of erosion must be given top priority for elimination, reduction, and control. Rills and gullies form sooner on exposed soils than on vegetated soils.

Stream and Channel Erosion

In general, one or more of the following factors that may occur during construction can change the hydrology of the area to affect erosion of the banks and bottoms of natural drainage channels:

- Clearing the soil and re-contouring the site during construction may increase the volume and rate of runoff leaving the site;
- Replacing pervious natural ground with impervious cover such as buildings and pavement further increases runoff; and/or
- Detention basins used to capture sediment extend the duration of flows leaving the site.

Control of erosion in streams and channels downstream of the construction site is a complex issue and is usually best addressed by City and other government agencies (e.g. DLNR and CORPS) through a mechanism such as a comprehensive drainage master plan. Where these plans are available, City may specify specific BMP requirements applicable to construction projects, which in turn must be incorporated into a SSBMPP. Where these plans are not available, the goal should be to minimize the difference between the predevelopment, construction, and post-construction hydrographs, and to minimize increases in sediment discharges. In some situations, State or City may require developers of large projects to conduct a study of the specific impacts related to development of the project. This will most likely be the case where municipal permits include new development and redevelopment provisions.

Wind Erosion

Wind erosion is the result of material movement by the wind. Airborne particles are lifted and moved to another location. Suspended particles may impact on solid objects causing erosion by abrasion. Dust is defined as solid particles or particulate matters which are predominately large enough to eventually settle out from the air but small enough to remain temporarily suspended in the air for an extended period of time. Dust from a construction site originates from rock and soil surfaces, material storage piles and construction materials. It is generated by earthwork, demolition, traffic on unpaved surfaces, and strong winds. See Table 1-2.

Table 1-2: Example of Dust Sources at Construction Sites

Vehicle and Equipment Use	Exposed Areas	Contractor Activities
<ul style="list-style-type: none"> ▪ Vehicle and equipment entering and leaving the project site ▪ Vehicle and equipment movement and use within the project site ▪ Sediment tracking off-site ▪ Temporary parking lots and staging areas ▪ On-site construction traffic 	<ul style="list-style-type: none"> ▪ Areas of exposed soil that have been cleared and grubbed ▪ Areas of exposed soil that have been excavated, filled, compacted, or graded ▪ Construction staging areas ▪ Vehicle and equipment storage and service areas ▪ Material processing areas and transfer points ▪ Construction roads ▪ Construction sites, bare ground areas ▪ Spill materials ▪ Construction stockpiles ▪ Soil and debris piles 	<ul style="list-style-type: none"> ▪ Land clearing and grubbing ▪ Earthwork including soil excavation, filling, soil compaction, rough grading, and final grading ▪ Drilling and blasting ▪ Material handling, including material stockpiling, transfer, and processing ▪ Batch dripping, dumping ▪ Conveyor transfer and stacking ▪ Material transferring ▪ Crushing, milling and screening operations ▪ Demolition and debris disposal ▪ Tilling

1.2.3 Other Pollutants

Erosion and sedimentation discharges are perhaps the most visible and significant source of pollutants associated with storm water at construction sites. However, other pollutants such as nutrients, bacteria, viruses, oil, grease, metals, organics, pesticides, gross pollutants, and vectors must always be considered, as they can be associated with both acute and chronic problems in receiving waters. Table 1-3 presents a matrix that identifies the most common source of these other pollutants at construction sites.

Table 1-3: Other Construction Activity Pollutants

Construction Activity	Pollutants						
	Sediments	Nutrients	Trace Metals	Pesticides	Oil, Grease, Fuels	Other Toxic Chemicals	Miscellaneous Waste
Construction Practices							
Dewatering Operations	X					X	
Paving Operations	X			X	X	X	X
Structure Construction/Painting			X			X	X
Material Management							
Material Delivery and Storage	X	X	X	X	X	X	
Material Use		X	X	X	X	X	
Waste Management							
Solid Waste	X	X					X
Hazardous Waste						X	
Contaminated Spills	X					X	
Concrete Waste							X
Sanitary/Septic Waste							X
Vehicle/Equipment Management							
Vehicle/Equipment Fueling						X	X
Vehicle/Equipment Maintenance						X	X

1.2.4 Impacts of Erosion and Sedimentation, and Other Pollutants

The impacts due to erosion and sedimentation can be placed in three categories:

- Degradation of aquatic and riparian ecosystems,
- Pollutant transport, and
- Erosion of land and sedimentation within waterways and public facilities (i.e. storm drains).

Sediment can be detrimental to aquatic life (primary producers, benthic invertebrates, and fish) by interfering with photosynthesis, respiration, growth, reproduction, and oxygen exchange in water bodies. In addition, sediment particles can transport other pollutants that are attached to

them including nutrients, trace metals, and hydrocarbons. Sediment particles such as silts and clays are the primary components of TSS, a common water quality analytical parameter.

In addition to impacts directly associated with sedimentation, various pollutants can also be transported along with sediment particles leaving construction sites. Such pollutants include metals, nutrients, conventional pollutants, pesticides, and coliform. These pollutants often originate from organic components, plant residues, and nutrient elements within soils on the construction site, and are thus mobilized by erosion and later deposited downstream during sedimentation. Alternatively, these other pollutants may be generated independent of erosion and because of their nature can have significant detrimental effects to receiving waters.

Construction activity may cause increased erosion and sedimentation within waterways and public facilities. Some construction activity will increase impervious area and/or change drainage patterns, resulting in increased runoff volumes and rates, which have the potential to erode downstream watercourses. Other construction activities such as grading may increase erosion from the construction site by disturbing and exposing the soil. The eroded soil particles from the construction site may flow downstream and fill drainage systems, reservoirs, and harbors.

1.3 REGULATORY PROGRAM

The need to protect our environment has resulted in a number of laws and subsequent regulations and programs. In the following sections, various Federal, State, and City programs are discussed in relationship to the control of pollutants in storm water. The programs are expected to change over the next several years and the user is advised to contact State and City officials for further information.

1.3.1 Federal NPDES Program

In 1972, the Federal Water Pollution Control Act (also referred to as the Clean Water Act [CWA]) was amended to provide that the discharge of pollutants to waters of the United States from any point source is unlawful unless the discharge is in compliance with a NPDES permit. The 1987 amendments to the CWA added Section 40 2(p), which establishes a framework for regulating municipal and industrial storm water discharges, including discharges associated with construction activities, under the NPDES Program.

On November 16, 1990, USEPA published final regulations that establish storm water permit application requirements. The regulations, also known as Phase I of the NPDES program, provide that discharges of storm water to waters of the United States from construction projects that encompass five or more acres of soil disturbance are effectively prohibited unless the discharge complies with an NPDES Permit.

On December 8, 1999, Phase II of the NPDES program expands the requirements by requiring operators of small Municipal Separate Storm Sewer Systems (MS4s) in urbanized areas and small construction sites to be covered under an NPDES permit and to implement programs and practices to control polluted storm water runoff. The program applies to:

- Operators of small MS4s located in “urbanized areas” as delineated by the Bureau of the Census. A “small” MS4 is any MS4 not already covered by the Phase I NPDES storm water program; and

- Small construction sites with a soil disturbance equal to or greater than one and less than five acres of land or part of a larger common plan of development which disturbs more than one acre.

1.3.2 State NPDES Programs

In Hawaii, the NPDES storm water permitting program is administered by State of Hawaii Department of Health (DOH) Clean Water Branch (CWB).

The CWB enforces the NPDES permits. The standard general permit conditions are found in the Hawaii Administrative Rules Title 11, Chapter 55 (HAR 11-55) Water Pollution, Appendix A Department of Health Standard Permit Conditions, and Appendix C NPDES General Permit Authorizing Discharges of Storm Water Associated with Construction Activity. This NPDES general permit for construction activities is normally triggered by projects covering one or more acres of land, such as the entire parcel(s) including paved, unpaved, disturbed, and undisturbed areas.

The CWB has established a construction general permit that can be applied to most construction activities in the state. Construction permittees may choose to obtain individual NPDES permits instead of obtaining coverage under the general permit, but this can be an expensive and complicated process, and its use should generally be limited to very large construction projects that discharge to critical receiving waters. Since individual permits are rare and would likely follow the general permit to a large extent, this manual is structured around the general permit.

In Hawaii, owners of construction projects of one or more acres may obtain NPDES permit coverage by filing a Notice of Intent (NOI) to be covered under the CWB, NPDES Notice of General Permit Coverage (NGPC), Appendix C, Discharges of Storm Water Associated with Construction Activities (General Permit). The NOI Form C can be downloaded (see Section 1.5 Reference). Construction activities discharging to City MS4 are restricted to conditions in the City's NPDES Permit HI S000002, effective March 31, 2006 and expiring September 8, 2009.

Requirements for individual NPDES permits are outlined in HAR 11-55. Generally, individual permits are triggered by sewage discharges or other point sources, including significant pollutant discharges(s) to State waters. The CWB Individual NPDES Form C and Guidelines (revised September 30, 2004) can be accessed at the CWB website

(<http://hawaii.gov/health/environmental/water/cleanwater/forms>).

The primary objectives of the general permit are to:

- Reduce erosion;
- Minimize or eliminate sediment in storm water discharges;
- Prevent materials used at a construction site from contacting storm water;
- Implement a sampling and analysis program if storm water is exposed to construction materials;
- Eliminate unauthorized non-storm water discharges from the construction sites;
- Implement appropriate measures to reduce potential impacts on waterways both during and after construction of projects; and
- Establish maintenance commitments on post-construction pollution control measures.

Failure to comply with the general permit may result in penalties and remedies provided in Chapter 342D Water Pollution of the Hawaii Revised Statutes, and possible imprisonment.

Who must comply with the construction general permit?

- The general permit applies to storm water discharges associated with construction activity which disturbs one acre or greater of soil, or at discretion by the Director; and
- The owner of the land is responsible for compliance.

When is a project not eligible for coverage under the construction general permit?

- Storm water discharges into sanitary sewers, storm waters regulated under existing individual permits, or storm water discharges to categories with USEPA discharge limitations are not eligible for general permit coverage;
- Storm water discharges which initially enter a separate storm water drainage system are not eligible, unless a permit, license or equivalent written approval is granted by the owner(s) of the drainage system(s) allowing the discharge to enter their system(s);
- Storm water discharges for which the director has issued a NGPC under another general permit specific to that type of construction or industrial activity are not eligible; and
- Storm water discharges that the director finds more appropriately regulated under an individual permit are not eligible.

Who does not need to seek coverage under the construction general permit?

- Activities to maintain the original line, grade, and hydraulic function of a facility, and emergency activities, do not require coverage under the general permit; and
- Construction activities meeting all three of the following criteria do not require coverage under the general permit, but minimum BMPs apply: (1) result in soil disturbances of less than one acre, (2) are not part of a larger common plan of development that disturbs one or more acres of soil, and (3) do not constitute a threat to water quality.

How to comply with construction general permit?

- Submit NOI and pay fees prior to the beginning of construction. Allow 30 working days for processing the NOI. A copy of the NOI can be found at CWB website <http://hawaii.gov/health/environmental/water/cleanwater/forms/genl-index.html>; and
- Prepare and submit SSBMPP before construction begins. The plan describes:
 - The project location, site features, and materials/activities that may result in the off-site discharge of pollutants during construction;
 - Controls to be implemented during construction - BMPs selected to control erosion, the discharge of sediment, and other pollutant sources; and
 - An inspection and maintenance program for BMPs.
 - Keep the BMPs plan on the site; implement it during construction and revise it as needed to reflect all phases of construction; and
 - Submit Notice of Cessation (NOC) when construction is complete and conditions of termination listed in the NOC have been satisfied. A copy of the NOC can be found at <http://hawaii.gov/health/environmental/water/cleanwater/forms/environmental/water/cleanwater/forms/index.html>.

1.3.3 *Municipal NPDES Programs*

Phase I Municipal Storm Water Program and municipal NPDES Permits cover and regulate municipalities with populations of over 100,000, drainage systems interconnected with these municipalities' systems, or municipalities determined to be significant contributors of pollutants.

Municipalities with NPDES storm water permits for their own MS4s are responsible for developing a management program for public and private construction activities in their jurisdiction. Each program addresses appropriate planning and construction procedures; ensures the implementation, inspection, and monitoring of construction sites which discharge storm water into their systems; and provides for education and training for construction site operators.

Phase II of the Storm Water Program will regulate municipalities with populations less than 100,000, including urbanized areas (areas with a population of 50,000 and density greater than 1,000 people per square mile), cities, and county areas designated by the state based on site-specific criteria, and various State and Federal facilities. Each designated entity must submit a NOI along with a copy of its Storm Water Management Program (SWMP). The Phase II SWMP must address six minimum control measures, including the following measures related to construction activities:

- Illicit Discharge Detection and Elimination - Developing and implementing a plan to detect and eliminate illicit discharges to the storm drain system including illicit connections and illegal dumping;
- Construction Site Storm Water Runoff Control - Developing, implementing, and enforcing an erosion and sediment control program for construction activities that disturb one or more acres of land; and
- Post Construction Storm Water Management in New Development and Redevelopment - Developing, implementing, and enforcing a program to address discharges of storm water runoff from new and redevelopment areas.

While Phase I and Phase II programs for construction sites vary throughout the state, the programs have many similarities, including the requirement for construction sites to comply with the General Permit. For specific information on State and City program requirements, construction site owners must contact the storm water program representative, such as DOH CWB and City Department of Environmental Services (ENV) Storm Water Quality Branch (SWQ).

1.4 DEFINITIONS

Many of the most common terms related to storm water quality control are defined in the Glossary (see Section 5). Throughout the manual, the user will find references to the following terms:

Maximum Extent Practicable (MEP) means economically achievable measures for the control of the addition of pollutants from existing and new categories and classes of nonpoint sources of pollution, which reflect the greatest degree of pollutant reduction achievable through the application of the best available nonpoint source pollution control practices, technologies, processes, siting criteria, operating methods or other alternatives. (ROH Section 14-12.2 Definitions, and City & County of Honolulu (CCH) Best Management Practices Manual for Construction Sites in Honolulu, May 1999).

NPDES General Permit for Storm Water Discharges. NPDES is an acronym for National Pollutant Discharge Elimination System. NPDES is the national program for administering and regulating Sections 307, 318, 402, and 405 of the Clean Water Act (CWA). In Hawaii, the Clean Water Branch (CWB) has issued a general permit for storm water discharges associated with construction activities.

Notice of Intent (NOI) is a formal notice to the CWB submitted by the owner/operators of existing industrial facilities. The NOI provides information on the permittee, location of discharge, type of discharge and certifies that the permittee will comply with conditions of the construction general permit. The NOI is not a permit application and does not require approval.

Sediment includes particles of sand, clay, silt, and other substances that settle at the bottom of a body of water. Sediment can come from the erosion of soil or from the decomposition of plants and animals. Wind, water, and ice often carry these particles great distances.

Best Management Practices (BMP) is defined as any program, technology, process, siting criteria, operating method, measure, or device, which controls, prevents, removes, or reduces pollution.

Source Control BMPs are operational practices that prevent pollution by reducing potential pollutants at the source.

Treatment Control BMPs are methods of treatment to remove pollutants from storm water.

1.5 REFERENCE

Berman, L., C. Hartline, N. Ryan, and J. Thorne, (1991), *Urban Runoff: Water Quality Solutions*. American Public Works Association, Special Report #61.

California Stormwater Quality Association (CASQA) Best Management Practices Handbook Construction, 2003.

City and County of Honolulu, Department of Planning and Permitting: Rules Relating to Soil Erosion Standards and Guidelines, April 1999.

Clark County Stormwater Pollution Control Manual Best Management Practices for Business and Government Agencies, 2000. Clark County Environmental Services Division, November 2000. On-line: <http://www.co.clark.wa.us/pubworks/BMPman.pdf>

King County Stormwater Pollution Control Manual. Best Management Practices for Businesses. King County Surface Water Management, July 1995. On-line: <http://dnr.metrokc.gov/wlr/dss/spcm.html>

Metzger, M.E., D. F. Messer, C. L. Beitia, C. M. Myers, and V. L. Kramer, 2002. *The Dark Side of Stormwater Runoff Management: Disease Vectors Associated with Structural BMPs.* Stormwater 3(2): 24-39.

National Stormwater Best Management Practices Database. American Society of Civil Engineers, 1999. On-line: <http://www.asce.org>

Pierce County Stormwater Pollution Prevention Manual: A Guide to Best Management Practices for Industries, Businesses and Homeowners. Pierce County Public Works and Utilities. Revised March 2002. On-line: <http://www.co.pierce.wa.us/services/home/environ/water/swm/sppman/index.html>

State of California Department of Transportation (Caltrans), Stormwater Quality Handbooks, 2000.

State of California Department of Transportation (Caltrans), Stormwater Quality Handbooks. Construction Contractor's Guide and Specifications, 1997.

State of California Department of Transportation (Caltrans), Stormwater Quality Handbooks, 1993.

State of Hawaii Department of Health Clean Water Branch, Hawaii Administrative Rules Title 11, Chapter 55 (October 8, 2007).

<http://www.hawaii.gov/health/environmental/water/cleanwater/forms/pdf/11-55.pdf>.

State of Hawaii Department of Health Clean Water Branch, NOI Form C and Guidelines: Appendix C-Storm Water Associated with Construction Activities.

<http://www.hawaii.gov/health/environmental/water/cleanwater/about/forms/gen1-index.html#CWB-NOI%20Form%20C>.

State of Hawaii Department of Health Clean Water Branch, Standard General Permit Conditions, Hawaii Administrative Rules, Title 11, Chapter 55, Appendix A.

<<http://www.hawaii.gov/health/environmental/water/cleanwater/about/stdcond.html#GeneralPermitConditions>>.

State Water Resources Control Board (1999) *NPDES General Permit No. CA2000002: Waste Discharge requirements for Discharges of Storm Water Runoff Associated with Construction Activity*. On-line: <http://www.swrcb.ca.gov/stormwtr/construction>

Stormwater Managers Resource Center. On-line: <http://www.stormwatercenter.net>

United States Environmental Protection Agency, Region 9: Water Programs: NPDES Storm Water Program. On-line: <http://www.epa.gov/region09/water/npdes/stormwater.html>

United States Environmental Protection Agency (1992) *Draft Stormwater Pollution Prevention for Industrial Activities*, Office of Wastewater Enforcement and Compliance.

United States Environmental Protection Agency (2000) *Storm Water Phase II Final Rule*, Office of Water, On-line: <http://www.epa.gov/npdes/pubs/fact1-0.pdf>

Urban Runoff Quality Management. Water Environment Federation/American Society of Civil Engineers, 1998. On-line: <http://www.wef.org>

SECTION 2: SITE-SPECIFIC CONSTRUCTION BMP PLAN (SSBMPP)

For projects totaling one acre or more, and activities that disturb less than one acre of total land area that is part of a larger common plan of development or sale if the larger common plan will ultimately disturb one acre or more of total land acres, a SSBMPP is required by DOH. Information on preparation and implementation of a construction activity SSBMPP can be found in the DOH, HAR 11-55 Water Pollution Control Appendix C NPDES General Permit Authorizing Discharges of Storm Water Associated with Construction Activity (General Permit), and City Department of Planning and Permitting (DPP) Rules Relating to Soil Erosion Standards and Guidelines (April 1999, or as amended).

The construction general permit for construction activity covers all areas of the State except for discharges in or to state waters classified by the department as “class 1, inland waters,” “class AA, marine waters,” and areas restricted in accordance with the State’s “No Discharge” policy in HAR 11-54 Water Quality Standards. If a project site discharges runoff into such areas, then the general permit will not be applicable, and an individual NPDES permit will be needed.

DOH requires that SSBMPP must be prepared before construction begins, ideally during the project planning and design phases. This is because much of the information required by the SSBMPP is already part of the project design documentation, and because the design may need to be modified to incorporate controls during construction and post-construction. It may be completed at the end of the design phase or at the initiation of the construction phase prior to any activity with the potential to cause water pollution.

Implementation of the SSBMPP begins when construction begins, typically before the initial clearing, grubbing, and grading operations, since these activities can usually increase erosion potential on the site. During construction, the SSBMPP should be referred to frequently, and amended by the owner and contractors as changes occur in construction operations, which could have significant effects on the potential for discharge of pollutants.

For construction projects with sites totaling less than one acre, DPP’s Rules Relating to Soil Erosion Standards and Guidelines (April 1999, or as amended) may apply. According to the standard, projects totaling 15,000 square feet or more for single-family or two-family dwelling uses, or 7,500 square feet or more for other uses, or in the event a proposed cut of fill is greater than 15 feet in height for single-family dwelling uses, or 7.5 feet in height for other uses, have been classified as Category 4 (large projects) and require submission and DPP approval of drainage and erosion control plans. The temporary erosion and sediment control measures included in the drainage and erosion control plan must be designed to limit soil loss during construction as determined by the Universal Soil Loss Equation (USLE) or alternately by using the Large Site BMP Checklist in the Rules Relating to Soil Erosion Standards and Guidelines (April 1999, or as amended). For the smaller projects (Category 2 and 3) requiring a grading permit where the area of the zoning lot or portion thereof subject to the permit is less than 15,000 square feet for single-family or two-family dwelling uses, or less than 7,500 square feet for other uses, minimum BMPs identified in the erosion control standard are required which are found the Minimum BMP Checklist. Under normal situations, DOH required construction general permit coverage is not necessary for projects classified as Category 2-4 based on size of projects.

2.1 ASSESS CONSTRUCTION SITE AND PLANNED ACTIVITIES

The planning phase is the source of much of the information needed for the SSBMPP. The basis for storm water pollution control decisions is also made at this phase via the normal review process with State or City. Information to be collected includes contractor activities, disturbed areas and erosion potential, and site history.

2.1.1 Contractor Activities

Information about contractor activities is required for the selection of proper BMPs. Details that should be recorded include:

- Equipment storage, cleaning and maintenance areas and activities;
- Points of ingress and egress to the construction site;
- Material loading, unloading, and storage practices and areas, including construction materials, building materials and waste materials; and
- Materials, equipment, or vehicles that may come in contact with storm water.

2.1.2 Disturbed Areas and Erosion Potential

The physical condition of the site and adjacent areas should be reviewed. A project layout showing what is being constructed, limits of construction, project schedule, and existing features should be developed. Site characteristics including drainage patterns, soils, vegetation, surface water bodies, and steep or unstable slopes should be noted. A hydrology report, soils report, and a grading/drainage plan should be prepared. Physical conditions at the site will change as construction progresses. The SSBMPP must be amended to address conditions as activities change at the site.

The hydrology reports should assess information such as drainage areas and patterns, rainfall information and expected run-on and runoff volumes and flow rates, etc. It is important for the preparer of the SSBMPPs to visit the site prior to writing the plan, and to confirm actual site conditions, such as drainage flow. A soil report will identify soil constraints, design criteria, and soil stability. Both of these reports are used in the preparation of the preliminary grading and drainage plan. The grading and drainage plan should identify areas of cut and fill, slope during and after grading, protection of existing vegetation, and areas of soil disturbance. They also form the technical basis for selection of erosion and sediment control BMPs.

2.1.3 Site History

Existing site characteristics such as vegetation, environmental features, and areas of historic contamination (natural and/or industrial or agricultural) should also be recorded on the project layout. Soil laboratory analysis may be required should prior contamination be suspected. The selection and implementation of construction BMPs will be affected by what existing features need to be protected or mitigated during construction.

2.2 IDENTIFY AND SELECT BMPs

The owner, the owner's design consultant, or the contractor, may select BMPs at the discretion of the owner. The contract between the owner and contractor should specify the responsibilities

of the owner and contractor with regards to storm water pollution control during construction. Owners must be aware that regardless of the contractual agreement between the owner and contractor with respect to BMP selection and implementation, the owner is ultimately responsible for compliance with the general permit.

A guide to selecting BMPs for construction activities is presented in the following sections. BMPs are generally selected in a three-step process:

- Define BMP objectives,
- Identify BMP category, and
- Select appropriate BMPs.

2.2.1 Define BMP Objectives

Selection and implementation of BMPs is based on the pollution risks associated with the construction activity. The pollution prevention objectives of BMPs are defined based on a review of information gathered during the assessment of the site and planned activities (Section 2.1). Once defined, BMP objectives are developed and BMPs selected. The BMP objectives for construction projects are as follows:

- Control of Erosion, and Discharge of Sediment:
 - Minimize Disturbed Areas: Only clear land which will be actively under construction in the near term (e.g., within the next 6-12 months), minimize new land disturbance during the rainy season, and avoid clearing and disturbing sensitive areas (e.g., steep slopes and natural watercourses) and other areas where site improvements will not be constructed. City Ordinance Section 14-15.1(e) states that the maximum sized parcel of land that may be opened for grading or grubbing is 15 acres. The area of land that may be opened may be reduced by the director of planning and permitting to control pollution and minimize storm damage.
 - Stabilize Disturbed Areas: Provide temporary stabilization of disturbed soils whenever active construction is not occurring on a portion of the site. Provide permanent stabilization during finish grade and landscape the site.
 - Protect Slopes and Channels: Safely convey runoff from the top of the slope and stabilize disturbed slopes as quickly as possible. Avoid disturbing natural channels. Stabilize temporary and permanent channel crossings as quickly as possible and ensure that increases in runoff velocity caused by the project do not erode the channel.
 - Control Site Perimeter: Delineate site perimeter to prevent disturbing areas outside the project limits. Divert upstream run-on safely around or through the construction project. City storm drainage ordinance and rules state that such diversions must not cause downstream property damage (Reference: ROH Section “Rules Relating to Storm Drainage Standards Part II – DESIGN STANDARDS GENERAL CONDITIONS”), or be diverted into another watershed. Runoff from the project site should be free of excessive sediment and other constituents. Control tracking at points of ingress to and egress from the project site.
 - Retain Sediment: Retain sediment-laden waters from disturbed, active areas within the site

- **Manage Non-Storm Water Discharges and Materials:**
 - **Practice Good Housekeeping:** Perform activities in a manner to keep potential pollutants from coming into contact with storm water or being transported off site to eliminate or avoid exposure.
 - **Contain Materials and Wastes:** Store construction, building, and waste materials in designated areas, protected from rainfall and contact with storm water runoff. Dispose of all construction waste in designated areas, and keep storm water from flowing onto or off of these areas. Prevent spills and clean up spilled materials.

2.2.2 Identify BMP Categories

Once the BMP objectives are defined, identify the category of BMP best suited to meet each objective. The particular BMP selected from each category depends on specific site conditions, construction activities, and cost considerations.

There are six BMP categories available for selection. They are:

- Erosion Control (EC),
- Sediment Control (SE),
- Wind Erosion Control (WE),
- Tracking Control (TR),
- Non-Storm Water Management (NS), and
- Waste Management and Materials Pollution Control (WM).

BMPs for erosion and sediment control are listed in the EC, SE, WE, and TR categories. BMPs for contractor activities are listed in the TR, NS, and WM categories.

2.2.3 Select BMPs

BMPs for Erosion and Sediment Control

BMPs for erosion and sediment control are selected to meet the BMP objectives based on specific site conditions, construction activities, and cost. Various BMPs may be needed at different times during construction since activities are constantly changing site conditions.

Selection of erosion control BMPs should be based on minimizing disturbed areas, stabilizing disturbed areas, and protecting slopes and channels. Selection of sediment control BMPs should be based on retaining sediment on-site and controlling the site perimeter. Erosion and sediment control BMPs are listed in the EC, SE, WE, and TR categories, which are presented in Section 3.

BMPs for Contractor Activities

Certain contractor activities may cause pollution if not properly managed. BMPs should be selected based on the contractor activities information collected in the BMPs plan. The materials and BMP objectives for contractor activities are practicing good housekeeping and containing materials and waste. BMPs for contractor activities are selected from the TR, NS and WM categories, which are presented in Sections 3 (TR) and 4 (NS, WM). Several considerations for selecting a BMP for contractor activities include:

- Is it expected to rain? Selection of a BMP is different for the rainy season versus the dry season. What activities can be postponed or re-scheduled until after the rains or performed during the dry season.
- How much water is being used? The more water used and wastewater generated, the more likely that pollutants transported by this water will reach the drainage system or be transported off site.
- What are the site conditions? BMPs may differ depending on whether the activity is conducted on a slope or flat ground near a drainage structure or watercourse. Conducting activities away from certain sensitive areas will reduce the cost and inconvenience of implementing BMPs.
- What about accidents? Controls for common activities should be established, and preparations should be made to allow for quick response to accidents or spills. In the event of a spill or exposure of construction compounds, what are the contingency plans for sampling the contaminated storm water? Can the analysis be done in the field or should laboratory analysis be required? Are sample bottles available on-site, appropriate test strips, etc.?

2.3 SITE INSPECTIONS

Weekly BMP inspections and maintenance by the contractor are required for projects impacting the City's storm drainage system. The City DPP "Construction Site BMPs Weekly Checklist" is available at the DPP website. For projects with one-acre or more of disturbed areas, the City's MS4 permit requires site inspections in accordance to the City's guidance "Inspection and Enforcement Program for Construction Sites (Jan 2000)," "Rules Relating to Soil Erosion Standards and Guidelines (April 1999)," and updates accepted by DOH.

At the onset of a construction project (e.g., clearing, grubbing, or earth movement) it may be more appropriate to perform inspection of the BMPs on a regular basis instead of just before and after a storm. This will allow sufficient time for any corrections or improvements to be made before the storm. An inspector should be identified in the BMPs plan. Inspection can usually be performed as part of a regular oversight and inspection of the project site.

For projects with disturbed areas totaling one acre or more; reference DOH HAR 11-55 Water Pollution Control Section 13 Record Retention. Record Retention require inspection records be retained for five years from the date they were generated. It is highly recommended that records be retained for at least five years following the date coverage is terminated under the general permit; even longer retention of records is recommended where sites have been subject to enforcement actions or are involved in litigation regarding issues covered by the permit.

2.4 BMP MONITORING

The type of BMP monitoring depends on which BMP is implemented. In the case of contractor activity BMPs, the monitoring consists of visual inspection to ensure that the BMP was implemented and maintained according to the BMPs plan. Such inspection would include:

- Looking for evidence of spills and resulting clean-up procedures (e.g., supplies of spill cleanup materials);
- Verifying adequacy of trash receptacles;

- Verifying waste disposal practices (e.g., recycle vs. hazardous waste bins);
- Examining integrity and use of containment structures;
- Verifying use of employee education programs for the various activities;
- Noting the location of activity (e.g., outdoor vs. indoor, concrete vs. grass); and
- BMPs for any chemicals or fuels not addressed in the BMPs plan must be developed.

In the case of erosion and sediment control BMPs, the monitoring program should consist of regular inspection to determine the following:

- Are erosion and sediment control BMPs installed properly? The BMPs plan should include details or references to allow for the proper construction of structural or vegetative erosion and sediment control devices. The inspector should ensure that these systems are installed according to the BMPs plan in the proper locations.
- Are the BMPs effective? The effectiveness of the BMP would be based on the presence of sediment behind or within control devices, the presence of sediment downstream of the site, and signs of erosion in stabilized areas after a storm event.
- Have drainage patterns changed? If the site has undergone significant grading operations, resulting in a change of drainage patterns, adjustment to the BMPs will likely be required to address this change. The inspector shall determine the extent of changes to the drainage pattern and the necessity for additional or reconfigured BMPs.
- Are areas stabilized as quickly as possible after completion of construction activities in an area? Disturbed active and inactive construction areas (inactive construction areas may be defined as areas in which no construction activity will occur for a period of 30 days or longer) should be stabilized as soon as practical. If construction, climatological, or other site conditions do not allow stabilization, the BMPs plan should define alternative approaches.
- Are the BMPs properly maintained? Maintenance of erosion and sediment control BMPs is critical. Erosion controls should be installed as soon as practical after an area becomes inactive, and before the onset of rain. The capacity of sediment controls must be restored prior to the next rain event.

2.5 BMP MAINTENANCE

The inspector should inspect the site on a regular basis, during and after any storm generating runoff to determine maintenance requirements and general condition of the installed system. DOH, ENV and/or Department of Design and Construction (DDC) inspectors may also inspect the site on a routine basis to assess the maintenance performed on the systems. All maintenance related to a storm event should be completed within 48 hours of the storm event. The following maintenance tasks should be performed on a regular basis:

- Removal of sediment from barriers and sedimentation devices,
- Replacement or repair of worn or damaged silt fence fabrics,
- Replacement or repair of damaged structural controls,
- Repair of damaged soil stabilization measures, and
- Other control maintenance as defined in each BMP fact sheet.

2.6 STORM WATER POLLUTION CONTROL DOCUMENTATION

Records of inspections, compliance certifications, and non-compliance reporting are to be retained for at least five years by the owner (Reference: DOH HAR 11-55 Water Pollution Control, 13 Record Retention). It is suggested that records of incidents such as spills or other releases be kept. Analyzing a history of this information can provide insight into modifying the BMPs. Photographs should also be kept.

Also, keep a record of maintenance activities or any other BMPs that are activity based. Activity based BMPs such as good housekeeping must be documented in each inspection; often, this documentation is the only evidence that the BMPs have been implemented.

SECTION 3: EROSION AND SEDIMENT CONTROL BMPs

3.1 EROSION CONTROL

Erosion control is any source control practice that protects the soil surface and prevents soil particles from being detached by rainfall, flowing water, or wind. Erosion control is also referred to as soil stabilization. Erosion control consists of preparing the soil surface and implementing one or more of the BMPs shown in Table 3-1, to disturbed soil areas.

All inactive soil-disturbed areas on the project site, and most active areas prior to the onset of rain, must be protected from erosion. Soil disturbed areas may include relatively flat areas as well as slopes. Typically, steep slopes and large exposed areas require the most robust erosion controls; flatter slopes and smaller areas still require protection, but less costly materials may be appropriate for these areas, allowing savings to be directed to the more robust BMPs for steep slopes and large exposed areas. To be effective, erosion control BMPs must be implemented at slopes and disturbed areas to protect them from concentrated flows.

Some erosion control BMPs can be used effectively to temporarily prevent erosion by concentrated flows. These BMPs, used alone or in combination, prevent erosion by intercepting, diverting, conveying, and discharging concentrated flows in a manner that prevents soil detachment and transport. Temporary concentrated flow conveyance controls may be required to direct run-on around or through the project in a non-erodible fashion. Temporary concentrated flow conveyance controls include the following BMPs:

- EC-9, Earth Dikes and Drainage Swales,
- EC-10, Velocity Dissipation Devices, and
- EC-11, Slope Drains.

Use of R-1 water (treated and disinfected wastewater with significant reduction in viral and bacterial pathogens) for sprayers and sprinklers used to water temporary or permanent vegetation must consider compatible surrounding land use. See “Guidelines for the Treatment and Use of Recycled Water, DOH Wastewater Branch, (May 2002).”

Table 3-1: Erosion Control BMPs

BMP#	BMP Name
EC-0	Employee/Subcontractor Training
EC-1	Scheduling
EC-2	Preservation of Existing Vegetation
EC-3	Hydraulic Mulch
EC-4	Hydroseeding
EC-5	Soil Binders
EC-7	Geotextiles and Mats
EC-8	Wood Mulching
EC-9	Earth Dikes and Drainage Swales
EC-10	Velocity Dissipation Devices
EC-11	Slope Drains
EC-12	Streambank Stabilization
EC-14	Seeding, Planting and Sodding
EC-15	Slope Roughening/Terracing
EC-16	Topsoil Management

3.2 SEDIMENT CONTROL

Sediment control is any practice that traps soil particles after they have been detached and moved by rain, flowing water, or wind. Sediment control measures are usually passive systems that rely on filtering or settling the particles out of the water or wind that is transporting them.

Sediment control practices include the BMPs listed in Table 3-2.

Sediment control BMPs include those practices that intercept and slow or detain the flow of storm water to allow sediment to settle and be trapped. Sediment control practices can consist of installing linear sediment barriers (such as silt fence, and sandbag barrier); providing fiber rolls, gravel bag berms, or check dams to break up slope length or flow; or constructing a sediment trap or sediment basin. Linear sediment barriers are typically placed below the toe of exposed and erodible slopes, down-slope of exposed soil areas, around soil stockpiles, and at other appropriate locations along the site perimeter.

A few BMPs may control both sediment and erosion, for example, fiber rolls and sand bag barriers. This manual classifies these BMPs as either erosion control (EC) or sediment control (SC) based on the BMPs most common and effective use.

Sediment control BMPs are most effective when used in conjunction with erosion control BMPs. The combination of erosion control and sediment control is usually the most effective means to prevent sediment from leaving the project site and potentially entering storm drains or receiving waters. Under most conditions, the general permit requires that the discharger implement an effective combination of erosion and sediment controls.

Under limited circumstances, sediment control alone may be appropriate. For example, applying erosion control BMPs to an area where excavation, filling, compaction, or grading is currently under way may not be feasible when storms come unexpectedly. Use of sediment controls by establishing perimeter control on these areas may be appropriate and allowable under the general permit provided the following conditions are met:

- Weather monitoring is under way;
- Inactive soil-disturbed areas have been protected with an effective combination of erosion and sediment controls;

Table 3-2: Temporary Sediment Control BMPs

BMP#	BMP Name
SE-1	Silt Fence
SE-2	Sediment Basin
SE-3	Sediment Trap
SE-4	Check Dams
SE-5	Fiber Rolls
SE-6	Gravel Bag Berm
SE-7	Street Sweeping and Vacuuming
SE-8	Sandbag Barrier
SE-10	Storm Drain Inlet Protection
SE-11	Chemical Treatment
SE-12	Locations of Potential Sources of Sediment
SE-13	Level Spreader
SE-14	Rip-Rap & Gabion Inflow Protection
SE-15	Vegetated Buffer Strips and Channels

- An adequate supply of sediment control materials is stored on-site and there are sufficient forces of labor and equipment available to implement sediment controls on the active area prior to the onset of rain; and
- The SSBMPP adequately describes the methods to protect active area.

Monitoring and maintenance of erosion and sedimentation control measures (ESCM) are necessary as specified in DPP's "Rules Relating to Soil Erosion Standards and Guidelines" (April 1999) Section 1-4.4.3.

The applicant shall also be required to submit a schedule for the monitoring and maintenance of ESCM. The name and phone numbers and means of contacting the individual responsible for the maintenance shall be provided. The responsible individual shall also be required to maintain a log of which ESCM was inspected, the time and date, any actions taken to maintain the ESCM, and any actions which need to maintain the ESCM.

When the required work is completed, a notation of the starting and finishing dates for the work shall be annotated into the inspection log. The responsible person shall also log, as necessary, the quantities and disposal site for sediment removed from an ESCM. The erosion and sedimentation control plan shall also include an emergency maintenance and repair plan for the ESCMs.

A plan for the long term monitoring and maintenance of permanent erosion control measures shall be submitted. The plan shall include the person or organization responsible for the monitoring and maintenance, the areas required for access to the permanent erosion control measures, the equipment, material and manpower requirements, the frequency and method of inspection, and any other information necessary to assess the monitoring and maintenance requirements.

3.3 WIND EROSION CONTROL

Wind erosion control consists of applying water or other dust palliatives to prevent or alleviate dust nuisance. Wind erosion control BMPs are shown in Table 3-3.

Table 3-3: Wind Erosion Control BMPs

BMP#	BMP Name
WE-1	Wind Erosion Control

Other BMPs that are sometimes applied to disturbed soil areas in order to control wind erosion are BMPs EC-1 through EC-5, shown in Section 0 of this manual. Be advised that many of the dust palliatives may contain compounds that have an unknown effect on storm water. A sampling and analysis protocol to test for storm water contamination from exposure to such compounds is required in the SSBMPP.

Use of recycled water for the purposes of wind erosion control must be approved by DOH Wastewater Branch.

3.4 TRACKING CONTROL BMPs

Tracking control consists of preventing or reducing the tracking of sediment off-site by vehicles leaving the construction area. Tracking control BMPs are shown in Table 3-4.

Attention to control of tracking sediment off site is highly recommended, as dirty streets and roads near a construction site create a nuisance to the public and generate constituent complaints to elected officials and regulators. These complaints often result in immediate inspections and regulatory actions.

Table 3-4: Temporary Tracking Control BMPs

BMP #	BMP Name
TR-1	Stabilized Construction Entrance/Exit
TR-2	Stabilized Construction Roadway
TR-3	Entrance/Outlet Tire Wash

3.5 EROSION AND SEDIMENT CONTROL BMP FACT SHEET FORMAT

A BMP fact sheet is a short document that gives all the information about a particular BMP. Typically, each fact sheet contains the information outlined in Figure 3-1. Completed fact sheets for each of the above activities are provided in Section 3.6.

Figure 3-1: Example Fact Sheet

<p>EC-xx Example Fact Sheet</p> <p><u>Description and Purpose</u></p> <p><u>Suitable Applications</u></p> <p><u>Limitations</u></p> <p><u>Costs</u></p> <p><u>Inspections and Maintenance</u></p> <p><u>References</u></p>

The fact sheets also contain side bar presentations with information on BMP objectives, targeted constituents, removal effectiveness, and potential alternatives.

3.6 BMP FACT SHEETS AND OBJECTIVES

BMP fact sheets for erosion, sediment, wind, and tracking controls follow. The BMP fact sheets are individually page numbered and are suitable for photocopying and inclusion in a site-specific BMPs plan.

Construction activities BMPs are designed to address one or more objectives to reduce the detrimental impact of pollutants caused by construction activities. Each BMP fact sheet lists the BMP objectives found on each front page, on the upper right-hand corner. A list of all the BMP fact sheets and their corresponding objectives are shown in Table 3-5.

Table 3-5: Erosion, Sediment, Wind and Tracking Control and BMP Objectives

BMP Category		BMP Objectives					
		Erosion Control	Sediment Control	Tracking Control	Wind Erosion Control	Non-Storm Water Management Control	Waste Management & Materials Pollution Control
Site Planning Considerations							
EC-0	Employee/Subcontractor Training						
EC-1	Scheduling	X	X	X	X		
EC-2	Preservation of Existing Vegetation	X	X				
SE-12	Location of Potential Sources of Sediment	X	X				
Vegetative Stabilization							
EC-3	Hydraulic Mulch	X			X		
EC-4	Hydroseeding	X			X		
EC-5	Soil Binders	X			X		
EC-8	Wood Mulching	X			X		
EC-14	Seeding, Planting and Sodding	X					
SE-14	Rip-Rap & Gabion Inflow Protection	X	X				
SE-15	Vegetated Buffer Strips and Channels	X	X				
SE-16	Compost Socks and Berms	X	X				
Physical Stabilization							
EC-7	Geotextiles and Mats	X			X		
EC-12	Streambank Stabilization	X	X			X	
EC-16	Topsoil Management	X	X		X		
SE-5	Fiber Rolls	X	X				
SE-6	Gravel Bag Berms	X	X				
SE-7	Street Sweeping and Vacuuming		X	X			
SE-8	Sandbag Barrier	X	X				
SE-13	Level Spreader	X					
TR-1	Stabilized Construction Entrance/Exit	X	X	X			
TR-2	Stabilized Construction Roadway	X	X	X			
TR-3	Entrance/Outlet Tire Wash		X	X			

BMP Category		BMP Objectives					
		Erosion Control	Sediment Control	Tracking Control	Wind Erosion Control	Non-Storm Water Management Control	Waste Management & Materials Pollution Control
Diversion Runoff							
EC-9	Earth Dikes and Drainage Swales	X					
EC-11	Slope Drain	X					
Velocity Reduction							
EC-10	Velocity Dissipation Devices	X					
EC-15	Slope Roughening/Terracing	X	X				
SE-4	Check Dams	X	X				
SE-10	Storm Drain Inlet Protection		X				
Sediment Trapping/Filtering							
SE-1	Silt Fence		X				
SE-2	Sediment Basin		X				
SE-3	Sediment Trap		X				
Other							
SE-11	Chemical Treatment		X				
WE-1	Wind Erosion Control		X		X		

3.7 EROSION CONTROL FACT SHEETS

- EC-0 Employee/Subcontractor Training
- EC-1 Scheduling
- EC-2 Preservation of Existing Vegetation
- EC-3 Hydraulic Mulch
- EC-4 Hydroseeding
- EC-5 Soil Binders
- EC-7 Geotextiles and Mats
- EC-8 Wood Mulching
- EC-9 Earth Dikes and Drainage Swales
- EC-10 Velocity Dissipation Devices
- EC-11 Slope Drains
- EC-12 Streambank Stabilization
- EC-14 Seeding, Planting and Sodding
- EC-15 Slope Roughening/Terracing
- EC-16 Topsoil Management





Description and Purpose

Training programs ensure that all employees and subcontractors understand the requirements of the Storm Water Management Program Plan as applicable to their responsibilities. Training topics include but are not limited to storm water management, potential contamination sources, and BMPs.

Employee/subcontractor training should be based on four objectives:

- Promote a clear identification and understanding of the problem, including activities with the potential to pollute storm water;
- Identify solutions (BMPs);
- Promote employee/subcontractor ownership of the problems and the solutions; and
- Integrate employee/subcontractor feedback into training and BMP implementation.

Suitable Applications

Employees involved in the planning, design, or construction phase of construction, repair, or maintenance activities within the City and County of Honolulu or project rights-of-way.

Limitations

- Degree of employee motivation and incentive to learn about BMP implementation.
- Availability of staff time to coordinate and conduct training.

Objectives

- EC – Erosion Control
- SE – Sediment Control
- TR – Tracking Control
- WE – Wind Erosion Control
- NS – Non-Storm Water Management Control
- WM – Waste Management & Materials Pollution Control

Legend:

- √ Primary Objective
- ▲ Secondary Objective

Targeted Constituents

- Sediment
- Nutrients
- Trash
- Metals
- Bacteria
- Oil and Grease
- Organics

Potential Alternatives

None

Implementation

- Integrate training regarding storm water quality management with existing training programs that may be required for your business by other regulations such as: the Safety and Health Program (Hawaii Occupational Safety and Health Standards), the Hazardous Waste Operations and Emergency Response (HAZWOPER) standard (29 CFR 1910.120), the Spill Prevention Control and Countermeasure (SPCC) Plan (40 CFR 112), and the Hazardous Materials Management Plan (Business Plan).
- Provide storm water management training through courses, seminars, workshops, product demonstrations, employee meetings, posters, and bulletin boards.
- Provide field training programs conducted by trained personnel.
- Maintain commitment and request input from senior City and County of Honolulu or project management.
- Promote open communication between employees involved in various stages of the projects.
- Improve storm water quality management based on past experience involving water quality problems at construction sites. Implement revised practices and procedures in training.
- Increase employee awareness of requirements and procedures for BMP monitoring and reporting.
- Businesses, particularly smaller ones that may not be regulated by Federal, State, or City and County regulations, may use the information in this Manual to develop a training program to reduce their potential to pollute storm water.
- Use the quick reference on disposal alternatives (Table 1.2) to train employee/subcontractors in proper and consistent methods for disposal.
- Consider posting the quick reference table around the job site or in the on-site office trailer to reinforce training.
- Train employee/subcontractors in standard operating procedures and spill cleanup techniques described in the fact sheets. Employee/Subcontractors trained in spill containment and cleanup should be present during the loading/unloading and handling of materials.
- Personnel who use pesticides should be trained in their use. The State Department of Agriculture, Pesticides Branch, licenses pesticide dealers, certifies pesticide applicators, and conducts on-site inspections.
- Proper education of off-site contractors is often overlooked. The conscientious efforts of well trained employee/subcontractors can be lost by unknowing off-site contractors, so make sure they are well informed about what they are expected to do on-site.

Costs

All of the above are low cost measures.

Inspection and Maintenance

Provide annual training on construction BMP implementation for all employees involved with construction activities.

References

City & County of Honolulu, Best Management Practices Manual for Construction Sites in Honolulu, Department of Environmental Services, May 1999.

Knoxville BMP Manual, 2003

State of Hawaii DOT, Highways Division Construction BMP Field Manual, September 2006.

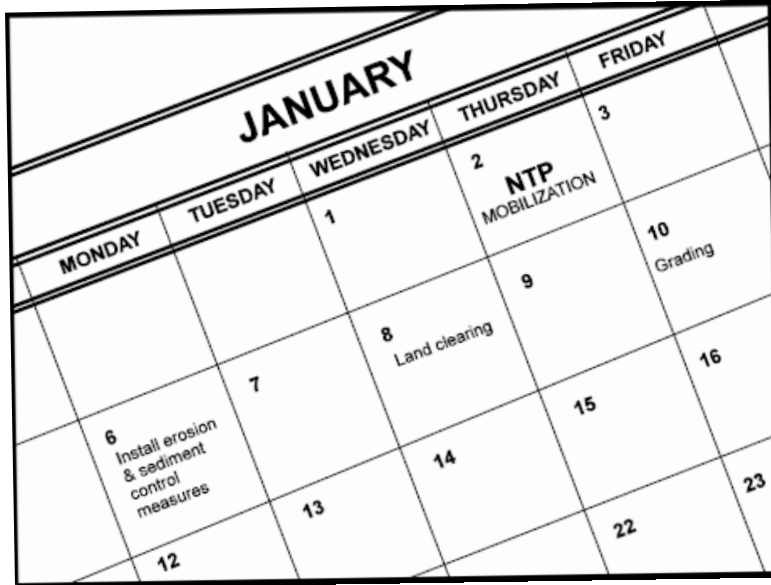

Description and Purpose

Scheduling is the development of a written plan that includes sequencing of construction activities and the implementation of BMPs such as erosion control and sediment control while taking local climate (rainfall, wind, etc.) into consideration. The purpose is to reduce the amount and duration of soil exposed to erosion by wind, rain, runoff, and vehicle tracking, and to perform the construction activities and control practices in accordance with the planned schedule.

Suitable Applications

Proper sequencing of construction activities to reduce erosion potential should be incorporated into the schedule of every construction project especially during rainy season. Use of other, more costly yet less effective, erosion and sediment control BMPs may often be reduced through proper construction sequencing.

City Ordinance Section 14-14.2 (c) (2), Application for a Grading Permit, requires the grading permittee to include a statement of schedules and sequence of construction operations. For projects with 1 acre or more disturbed sites, the Hawaii State Department of Health (DOH) and Clean Water Branch (CWB) requires a schedule so that construction is sequenced to minimize the exposure time of the cleared surface area.

Limitations

- Environmental constraints such as nesting season prohibitions reduce the full capabilities of this BMP.

Objectives

EC – Erosion Control	√
SE – Sediment Control	▲
TR – Tracking Control	▲
WE – Wind Erosion Control	▲
NS – Non-Storm Water Management Control	▲
WM – Waste Management & Materials Pollution Control	▲

Legend:

- √ Primary Objective
- ▲ Secondary Objective

Targeted Constituents

Sediment	√
Nutrients	
Trash	
Metals	
Bacteria	
Oil and Grease	
Organics	

Potential Alternatives

None

Implementation

- Avoid rainy periods. Schedule major grading operations during dry months when practical. Allow enough time before rainfall begins to stabilize the soil with vegetation or physical means or to install sediment trapping devices.
- Plan the project and develop a schedule showing each phase of construction. Clearly show how the rainy season relates to soil disturbing and re-stabilization activities. Incorporate the construction schedule into the site-specific BMPs plan.
- Include on the schedule, details on the rainy season implementation and deployment of:
 - Erosion control BMPs,
 - Sediment control BMPs,
 - Tracking control BMPs,
 - Wind erosion control BMPs,
 - Non-storm water BMPs, and
 - Waste management and materials pollution control BMPs.
- Include dates for activities that may require non-storm water discharges such as dewatering, sawcutting, grinding, drilling, boring, crushing, blasting, painting, hydro-demolition, mortar mixing, pavement cleaning, etc.
- Work out the sequencing and timetable for the start and completion of each item such as site clearing and grubbing, grading, excavation, paving, foundation pouring utilities installation, etc., to minimize the active construction area during the rainy season:
 - Sequence trenching activities so that most open portions are closed before new trenching begins;
 - Incorporate staged seeding and re-vegetation of graded slopes as work progresses; and
 - Schedule establishment of permanent vegetation during appropriate planting time for specified vegetation.
- Non-active areas should be stabilized as soon as practical after the cessation of soil disturbing activities or one day prior to the onset of precipitation.
- Monitor the weather forecast for rainfall.
- When rainfall is predicted, adjust the construction schedule to allow the implementation of soil stabilization and sediment treatment controls on all disturbed areas prior to the onset of rain.
- Be prepared year round to deploy erosion control and sediment control BMPs. Erosion may be caused during dry seasons by un-seasonal rainfall, wind, and vehicle tracking. Keep the site stabilized year round, and retain and maintain rainy season sediment trapping devices in operational condition.
- Apply permanent erosion control to areas deemed substantially complete during the project's defined seeding window.
- For additional Scheduling information, refer to the City & County of Honolulu, Department of Planning and Permitting "Rules Relating to Soil Erosion Standards and Guidelines" (April 1999), Section 1-4.4.2 Scheduling, Time Frame, and Sequencing of Construction.

Costs

Construction scheduling to reduce erosion may increase other construction costs due to reduced economies of scale in performing site grading. The cost effectiveness of scheduling techniques should be compared with the other less effective erosion and sedimentation controls to achieve a cost effective balance.

Inspection and Maintenance

- Verify that work is progressing in accordance with the schedule. If progress deviates, take corrective actions.
- Amend the schedule when changes are warranted.
- Amend the schedule prior to the rainy season to show updated information on the deployment and implementation of construction site BMPs.

References

California Stormwater Quality Association (CASQA) Best Management Practices Handbook Construction, 2003.

Hawaii Administrative Rules, Title 11, Chapter 55, Water Pollution Control, Appendix C, NPDES General Permit Authorizing Discharges of Storm Water Associated with Construction Activity, Hawaii State Department of Health (DOH) Clean Water Branch, p. 55-C-11
<http://www.hawaii.gov/health/about/rules/admrules.html>

Revised Ordinances of Honolulu Section 14, Article 15. Grading, Grubbing & Stockpiling,
http://www.honolulu.gov/menu/government/gov_resources/refs/index.html

Stormwater Management for Construction Activities Developing Pollution Prevention Plans and Best Management Practices (EPA 832-R-92-005), U.S. Environmental Protection Agency, Office of Water, September 1992.

Stormwater Quality Handbooks Construction Site Best Management Practices (BMPs) Manual, State of California Department of Transportation (Caltrans), November 2000.

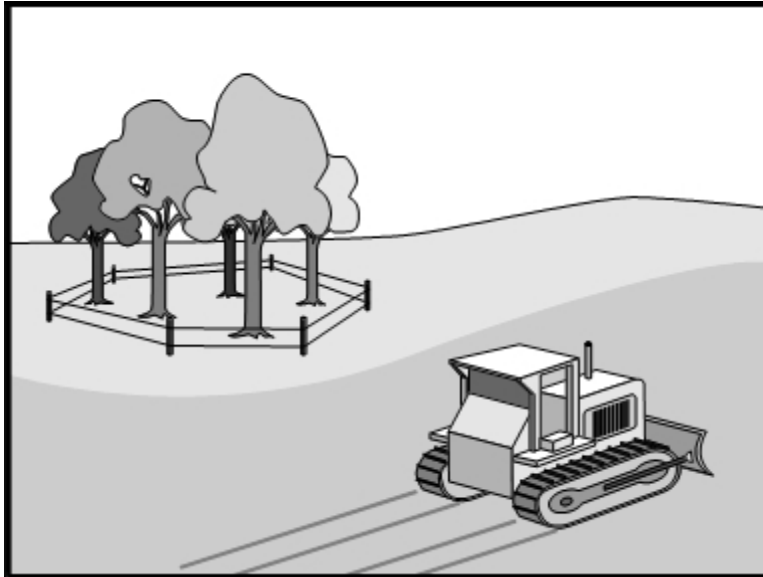

Description and Purpose

Carefully planned preservation of existing vegetation minimizes the potential of removing or injuring existing trees, vines, shrubs, and grasses that protect soil from erosion.

Both State and City regulations recommend preservation of existing vegetation whenever feasible.

Suitable Applications

Preservation of existing vegetation is suitable for use on most projects. Large project sites often provide the greatest opportunity for use of this BMP. Suitable applications include the following:

- Areas within the site where no construction activity occurs, or occurs at a later date. This BMP is especially suitable to multi-year projects where grading can be phased.
- Areas where natural vegetation exists and is designated for preservation. Such areas often include steep slopes, watercourse, and building sites in wooded areas.
- Areas where city, state, and federal government require preservation, such as vernal pools, wetlands, marshes, certain oak trees, etc. These areas are usually designated on the plans, or in the specifications, permits, or environmental documents.
- Where vegetation designated for ultimate removal can be temporarily preserved and be utilized for erosion control and sediment control.

Objectives

- EC – Erosion Control ✓
- SE – Sediment Control
- TR – Tracking Control
- WE – Wind Erosion Control
- NS – Non-Storm Water Management Control
- WM – Waste Management & Materials Pollution Control

Legend:

- ✓ Primary Objective
- ▲ Secondary Objective

Targeted Constituents

- Sediment ✓
- Nutrients
- Trash
- Metals
- Bacteria
- Oil and Grease
- Organics

Potential Alternatives

None

Limitations

- Requires forward planning by the owner/developer, contractor, and design staff.
- Limited opportunities for use when project plans do not incorporate existing vegetation into the site design.
- For sites with diverse topography, it is often difficult and expensive to save existing trees while grading the site satisfactory for the planned development.

Implementation

The best way to prevent erosion is to not disturb the land. In order to reduce the impacts of new development and redevelopment, projects may be designed to avoid disturbing land in sensitive areas of the site (e.g., natural watercourses, steep slopes), and to incorporate unique or desirable existing vegetation into the site's landscaping plan. Clearly marking and leaving a buffer area around these unique areas during construction will help to preserve these areas as well as take advantage of natural erosion prevention and sediment trapping.

Existing vegetation to be preserved on the site should be protected from mechanical and other injury while the land is being developed. The purpose of protecting existing vegetation is to ensure the survival of desirable vegetation for shade, beautification, and erosion control. Mature vegetation has extensive root systems that help to hold soil in place, thus reducing erosion. In addition, vegetation helps keep soil from drying rapidly and becoming susceptible to erosion. To effectively save existing vegetation, no disturbances of any kind should be allowed within a defined area around the vegetation. For trees, no construction activity should occur within the drip line of the tree.

Timing

- Provide for preservation of existing vegetation prior to the commencement of clearing and grubbing operations or other soil disturbing activities in areas where no construction activity is planned or will occur at a later date.

Design and Layout

- Mark areas to be preserved with temporary fencing. Include sufficient setback to protect roots:
 - Orange colored plastic mesh fencing works well; and
 - Use appropriate fence posts and adequate post spacing and depth to completely support the fence in an upright position.
- Locate temporary roadways, stockpiles, and layout areas to avoid stands of trees, shrubs, and grass.
- Consider the impact of grade changes to existing vegetation and the root zone.
- Maintain existing irrigation systems where feasible. Temporary irrigation may be required.
- Instruct employees and subcontractors to honor protective devices. Prohibit heavy equipment, vehicular traffic, or storage of construction materials within the protected area.

Costs

There is little cost associated with preserving existing vegetation if properly planned during the project design, and these costs may be offset by aesthetic benefits that enhance property values. During construction, the cost for preserving existing vegetation will likely be less than the cost of applying erosion and sediment controls to the disturbed area. Replacing vegetation inadvertently destroyed during construction can be extremely expensive, sometimes in excess of \$10,000 per tree in California. Note that Hawaii's unit prices are higher than California's unit prices.

Inspection and Maintenance

During construction, the limits of disturbance should remain clearly marked at all times. Irrigation or maintenance of existing vegetation should be described in the landscaping plan. If damage to protected trees still occurs, maintenance guidelines described below should be followed:

- Verify that protective measures remain in place. Restore damaged protection measures immediately.
- Serious tree injuries should be attended to by an arborist.
- Damage to the crown, trunk, or root system of a retained tree should be repaired immediately.
- Trench as far from tree trunks as possible, usually outside of the tree drip line or canopy. Curve trenches around trees to avoid large roots or root concentrations. If roots are encountered, consider tunneling under them. When trenching or tunneling near or under trees to be retained, place tunnels at least 18 in. below the ground surface, and not below the tree center to minimize impact on the roots.
- Do not leave tree roots exposed to air. Cover exposed roots with soil as soon as possible. If soil covering is not practical, protect exposed roots with wet burlap or peat moss until the tunnel or trench is ready for backfill.
- Cleanly remove the ends of damaged roots with a smooth cut.
- Fill trenches and tunnels as soon as possible. Careful filling and tamping will eliminate air spaces in the soil, which can damage roots.
- If bark damage occurs, cut back all loosened bark into the undamaged area, with the cut tapered at the top and bottom and drainage provided at the base of the wood. Limit cutting the undamaged area as much as possible.
- Aerate soil that has been compacted over a tree's root zone by punching holes 12 in. deep with an iron bar, and moving the bar back and forth until the soil is loosened. Place holes 18 in. apart throughout the area of compacted soil under the tree crown.
- Fertilization:
 - Fertilize stressed or damaged broadleaf trees to aid recovery;
 - Fertilize trees in the late fall or early spring; and
 - Apply fertilizer to the soil over the feeder roots and in accordance with label instructions, but never closer than 3 ft. to the trunk. Increase the fertilized area by one-fourth of the crown area for conifers that have extended root systems.
- Retain protective measures until all other construction activity is complete to avoid damage during site cleanup and stabilization.

References

California Stormwater Quality Association (CASQA) Best Management Practices Handbook Construction, 2003.

County of Sacramento Tree Preservation Ordinance, September 1981.

Hawaii Administrative Rules, Title 11, Chapter 55, Water Pollution Control, Appendix C, NPDES General Permit Authorizing Discharges of Storm Water Associated with Construction Activity, Hawaii State Department of Health (DOH) Clean Water Branch, p. 55-C-11.

Revised Ordinances of Honolulu, Section 14, Article 15, Grading, Grubbing & Stockpiling.

Stormwater Management of the Puget Sound Basin, Technical Manual, Publication #91-75, Washington State Department of Ecology, February 1992.

Stormwater Quality Handbooks Construction Site Best Management Practices (BMPs) Manual, State of California Department of Transportation (Caltrans), November 2000.

Water Quality Management Plan for The Lake Tahoe Region, Volume II, Handbook of Management Practices, Tahoe Regional Planning Agency, November 1988.

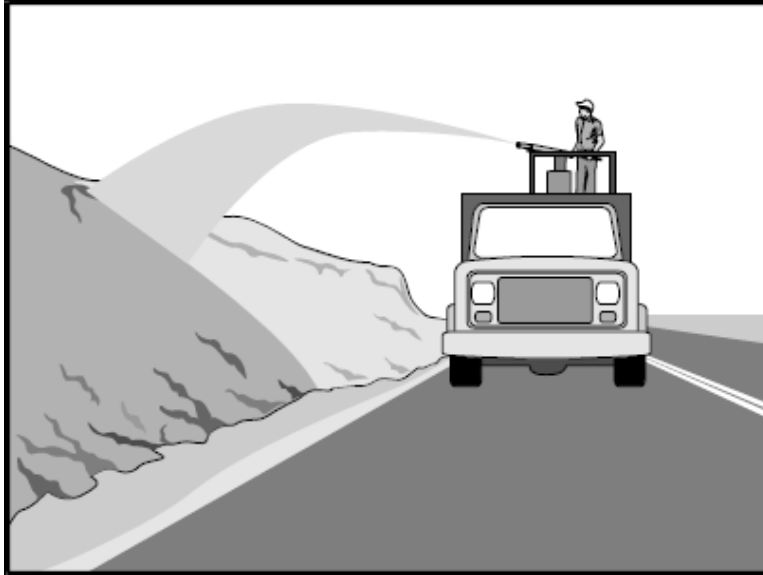

Description and Purpose

Hydraulic mulch consists of various types of fibrous materials mixed with water and sprayed onto the soil surface in slurry form to provide a layer of temporary protection from wind and water erosion.

Suitable Applications

Hydraulic mulch is suitable for soil disturbed areas requiring temporary protection until permanent stabilization is established, and disturbed areas that will be re-disturbed following an extended period of inactivity.

Limitations

Wood fiber hydraulic mulches are generally short lived and need 24 hours to dry before rainfall occurs to be effective. May require a second application in order to remain effective for an entire rainy season.

Implementation

- Prior to application, roughen embankment and fill areas by rolling with a crimping or punching type roller or by track walking. Track walking should only be used where other methods are impractical.
- To be effective, hydraulic matrices require 24 hours to dry before rainfall occurs.
- Avoid mulch over spray onto roads, sidewalks, drainage channels, existing vegetation, etc.
- Hydraulic mulch can also include a vegetative component, such as seed, rhizomes, or stolons (see EC-4 Hydroseeding).

Objectives

- EC – Erosion Control ✓
- SE – Sediment Control
- TR – Tracking Control
- WE – Wind Erosion Control ▲
- NS – Non-Storm Water Management Control
- WM – Waste Management & Materials Pollution Control

Legend:

- ✓ Primary Objective
- ▲ Secondary Objective

Targeted Constituents

- Sediment ✓
- Nutrients
- Trash
- Metals
- Bacteria
- Oil and Grease
- Organics

Potential Alternatives

- EC-4 Hydroseeding
- EC-5 Soil Binders
- EC-7 Geotextiles and Mats
- EC-8 Wood Mulching

Standard Hydraulic Mulches

Standard hydraulic mulches are generally applied at a rate of 2,000 lb/acre and are manufactured containing approximately 5% tackifier (i.e. soil binder), usually a plant derived guar or psyllium type. Most standard mulches are green in color derived from food-color based dyes.

Hydraulic Matrices (HM) and Stabilized Fiber Matrices (SFM)

Hydraulic matrices and stabilized fiber matrices are slurries which contain increase levels of tackifiers/soil binders; usually 10% or more by weight. HMs and SFMs have improved performance compared to a standard hydraulic mulch because of additional percentage of tackifier and because of their higher typical application rates, 2,500 - 4,000 lb/acre. Hydraulic matrices can include a mixture of fibers, for example, a 50/50 blend of wood and paper fiber. In the case of and SFM, the tackifier/soil binder is specified as a polyacrylamide (PAM). Hydraulic matrices include a mixture of wood fiber and acrylic polymer or other tackifier as binder.

Bonded Fiber Matrix (BFM)

Bonded fiber matrix is a hydraulically applied system of fibers and adhesives that upon drying forms an erosion resistant blanket that promotes vegetation, and prevents soil erosion. BFM's are typically applied at rates from 3,000 lb/acre to 4,000 lb/acre based on the manufacturer's recommendation. A biodegradable BFM is composed of materials that are 100% biodegradable. The binder in the BFM should also be biodegradable and should not dissolve or disperse upon re-wetting. Typically, biodegradable BFM's should not be applied immediately before, during or immediately after rainfall if the soil is saturated. Depending on the product, BFM's typically require 12 to 24 hours to dry and become effective.

Mechanically-Bonded Fiber Matrix (MBFM)

Bonded fiber matrix (BFM) is a hydraulically applied system of fibers and adhesives that upon drying forms an erosion resistant blanket that promotes vegetation, and prevents soil erosion. BFM's are typically applied at rates from 3,000 lb/acre to 4,000 lb/acre based on the manufacturer's recommendation. A biodegradable BFM is composed of materials that are 100% biodegradable. The binder in the BFM should also be biodegradable and should not dissolve or disperse upon re-wetting. Typically, biodegradable BFM's should not be applied immediately before, during or immediately after rainfall if the soil is saturated. Depending on the product, BFM's typically require 12 to 24 hours to dry and become effective.

Costs

Average installed cost for hydraulic mulch categories are provided in table below. Note that Hawaii's unit prices are higher than California's unit prices

Hydraulic Mulch Type	Average Installed Cost
Standard Hydraulic Mulches	\$2,600/acre
Hydraulic Matrices and Stabilized Fiber Matrices	
Guar-based	\$3,000/acre
PAM-base	\$4,050/acre
Bonded Fiber Matrix	\$5,400/acre
Mechanically Bonded Fiber Matrix	\$5,250/acre

Inspection and Maintenance

- Inspect BMPs prior to forecast rain, daily during extended rain events, after rain events, weekly during the rainy season, and at two-week intervals during the non-rainy season.
- Areas where erosion is evident should be repaired and BMPs re-applied as soon as possible. Care should be exercised to minimize the damage to protected areas while making repairs, as any area damaged will require re-application of BMPs.
- Maintain an unbroken, temporary mulched ground cover throughout the period of construction when the soils are not being reworked.

References

California Stormwater Quality Association (CASQA) Best Management Practices Handbook Construction, 2003.

Controlling Erosion of Construction Sites Agricultural Information #347, U.S. Department of Agriculture (USDA), Natural Resources Conservation Service (NRCS) (formerly Soil Conservation Service – SCS).

Guidance Document: Soil Stabilization for Temporary Slopes, State of California Department of Transportation (Caltrans), November 1999.

Guides for Erosion and Sediment Control in California, USDA Soils Conservation Service, January 1991.

Manual of Standards of Erosion and Sediment Control Measures, Association of Bay Area Governments, May 1995.

Sedimentation and Erosion Control, An Inventory of Current Practices Draft, US EPA, April 1990.

Soil Erosion by Water, Agriculture Information Bulletin #513, U.S. Department of Agriculture, Soil Conservation Service.

Stormwater Management of the Puget Sound Basin, Technical Manual, Publication #91-75, Washington State Department of Ecology, February 1992.

Stormwater Quality Handbooks Construction Site Best Management Practices (BMPs) Manual, State of California Department of Transportation (Caltrans), November 2000.

Water Quality Management Plan for the Lake Tahoe Region, Volume II, Handbook of Management Practices, Tahoe Regional Planning Agency, November 1988.

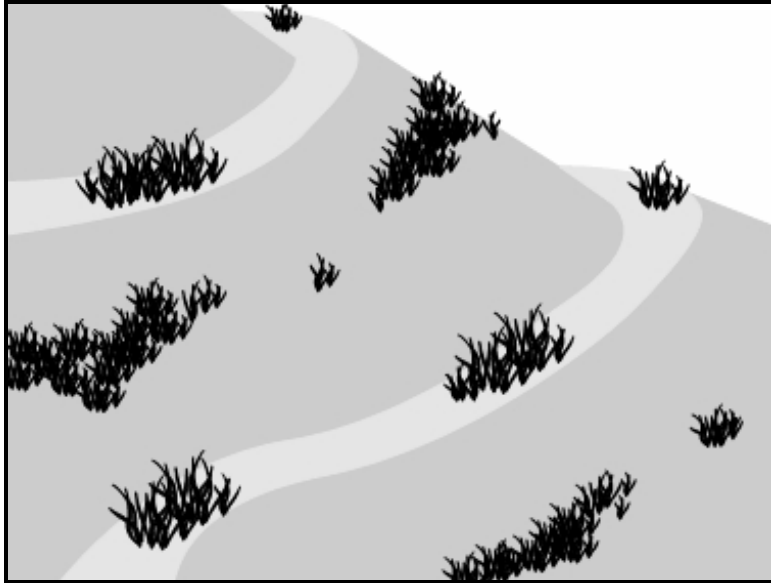

Description and Purpose

Hydroseeding typically consists of applying a mixture of wood fiber, seed, fertilizer, and stabilizing emulsion with hydro-mulch equipment, to temporarily protect exposed soils from erosion by water and wind.

Suitable Applications

Hydroseeding is suitable for soil disturbed areas requiring temporary protection until permanent stabilization is established, and disturbed areas that will be re-disturbed following an extended period of inactivity.

Limitations

- Hydroseeding may be used alone only when there is sufficient time in the season to ensure adequate vegetation establishment and coverage to provide adequate erosion control. Otherwise, hydroseeding should be used in conjunction with mulching (i.e., straw mulch).
- Steep slopes are difficult to protect with temporary seeding. Per EC-9 Earth Dikes and Drainage Swales, seeding is allowed for less than 5% slopes.
- Temporary seeding may not be appropriate in dry periods without supplemental irrigation.
- Temporary vegetation may have to be removed before permanent vegetation is applied.
- Temporary vegetation is not appropriate for short term inactivity.

Objectives

- EC – Erosion Control ✓
- SE – Sediment Control
- TR – Tracking Control
- WE – Wind Erosion Control ▲
- NS – Non-Storm Water Management Control
- WM – Waste Management & Materials Pollution Control

Legend:

- ✓ Primary Objective
- ▲ Secondary Objective

Targeted Constituents

- Sediment ✓
- Nutrients
- Trash
- Metals
- Bacteria
- Oil and Grease
- Organics

Potential Alternatives

- EC-3 Hydraulic Mulch
- EC-5 Soil Binders
- EC-7 Geotextiles and Mats
- EC-8 Wood Mulching

Implementation

In order to select appropriate hydroseeding mixtures, an evaluation of site conditions should be performed with respect to:

- Soil conditions,
- Site topography,
- Season and climate,
- Vegetation types,
- Maintenance requirements,
- Sensitive adjacent areas,
- Water availability, and
- Plans for permanent vegetation.

Seed type should be carefully selected based upon anticipated soil type and future irrigation. For example, use of centipede or carpet grass seeds may perform better in soils with low fertility and moisture content.

The Hawaii office of the U.S.D.A. Natural Resources Conservation Service (NRCS) is an excellent source of information on appropriate seed mixes.

The following steps should be followed for implementation:

- Avoid use of hydroseeding in areas where the BMP would be incompatible with future earthwork activities and would have to be removed.
- Hydroseeding can be accomplished using a multiple step or one step process. The multiple step process ensures maximum direct contact of the seeds to soil. When the one step process is used to apply the mixture of fiber, seed, etc., the seed rate should be increased to compensate for all seeds not having direct contact with the soil.
- Prior to application, roughen the area to be seeded with the furrows trending along the contours.
- Apply a straw mulch to keep seeds in place and to moderate soil moisture and temperature until the seeds germinate and grow.
- All seeds should be in conformance with the State of Hawaii Department of Agriculture (HDOA). Each seed bag should be delivered to the site sealed and clearly marked as to species, purity, percent germination, dealer's guarantee, and dates of test. The container should be labeled to clearly reflect the amount of Pure Live Seed (PLS) contained. All legume seed should be pellet inoculated. Inoculant sources should be species specific and should be applied at a rate of 2 lb of inoculant per 100 lb seed. Noxious species listed by HDOA are not permitted.
- Commercial fertilizer should conform to industry and suppliers requirements. Fertilizer should be pelleted or granular form.
- Follow up applications should be made as needed to cover weak spots and to maintain adequate soil protection.
- Avoid over spray onto roads, sidewalks, drainage channels, existing vegetation, etc.

Costs

In California, average cost for installation and maintenance may vary from as low as \$300 per acre for flat slopes and stable soils, to \$1600 per acre for moderate to steep slopes and/or erosive soils. Note that Hawaii's unit prices are higher than California's unit prices.

Hydroseeding		Installed Cost per Acre
High Density	Ornamentals	\$400-\$1,600
	Turf Species	\$350
	Bunch Grasses	\$300-1,300
Fast Growing	Annual	\$350-\$650
	Perennial	\$300-\$800
Non-Competing	Native	\$300-\$1,600
	Non-Native	\$400-\$500
Sterile	Cereal Grain	\$500

Source: Caltrans Guidance for Soil Stabilization for Temporary Slopes, Nov. 1999

Inspection and Maintenance

- Inspect BMPs prior to forecast rain, daily during extended rain events, after rain events, weekly during the rainy season, and at two-week intervals during the non-rainy season.
- Areas where erosion is evident should be repaired and BMPs re-applied as soon as possible. Care should be exercised to minimize the damage to protected areas while making repairs, as any area damaged will require re-application of BMPs.
- Where seeds fail to germinate, or they germinate and die, the area should be re-seeded, fertilized, and mulched within the planting season, using not less than half the original application rates.
- Irrigation systems, if applicable, should be inspected daily while in use to identify system malfunctions and line breaks. When line breaks are detected, the system should be shut down immediately and breaks repaired before the system is put back into operation.
- Irrigation systems should be inspected for complete coverage and adjusted as needed to maintain complete coverage.

References

California Stormwater Quality Association (CASQA) Best Management Practices Handbook Construction, 2003.

Guidance Document: Soil Stabilization for Temporary Slopes, State of California Department of Transportation (Caltrans), November 1999.

Hawaii Administrative Rules, Chapter 67, Seed Rules, Title 4, Subtitle 6, Hawaii State Department of Agriculture (HDOA), Division of Plant Industry
<http://www.hawaii.gov/hdoa/admin-rules.html>.

Stormwater Quality Handbooks Construction Site Best Management Practices (BMPs) Manual, State of California Department of Transportation (Caltrans), November 2000.



Description and Purpose

Soil binders consist of applying and maintaining a soil stabilizer to exposed soil surfaces. Soil binders are materials applied to the soil surface to temporarily prevent water induced erosion of exposed soils on construction sites. Soil binders also prevent wind erosion.

Suitable Applications

Soil binders are typically applied to disturbed areas requiring short term temporary protection. Because soil binders can often be incorporated into the work, they are a good alternative to mulches in areas where grading activities will soon resume. Soil binders are also suitable for use on stockpiles.

Limitations

- Soil binders are temporary in nature and may need reapplication.
- Soil binders require a minimum curing time until fully effective, as prescribed by the manufacturer. Curing time may be 24 hours or longer. Soil binders may need reapplication after a storm event.
- Soil binders will generally experience spot failures during heavy rainfall events. If runoff penetrates the soil at the top of a slope treated with a soil binder, it is likely that the runoff will undercut the stabilized soil layer and discharge at a point further down slope.
- Soil binders do not hold up to pedestrian or vehicular traffic across treated areas.

Objectives

- EC – Erosion Control ✓
- SE – Sediment Control
- TR – Tracking Control
- WE – Wind Erosion Control ▲
- NS – Non-Storm Water Management Control
- WM – Waste Management & Materials Pollution Control

Legend:

- ✓ Primary Objective
- ▲ Secondary Objective

Targeted Constituents

- Sediment ✓
- Nutrients
- Trash
- Metals
- Bacteria
- Oil and Grease
- Organics

Potential Alternatives

- EC-3 Hydraulic Mulch
- EC-4 Hydroseeding
- EC-7 Geotextiles and Mats
- EC-8 Wood Mulching

- Soil binders may not penetrate soil surfaces made up primarily of silt and clay, particularly when compacted.
- Some soil binders may not perform well with low relative humidity. Under rainy conditions, some agents may become slippery or leach out of the soil.
- Soil binders may not cure if low temperatures occur within 24 hours of application.
- The water quality impacts of soil binders are relatively unknown and some may have water quality impacts due to their chemical makeup.
- A sampling and analysis plan should be incorporated into the site-specific BMPs plan as soil binders could be a source of non-visible pollutants.

Implementation

General Considerations

- Regional soil types will dictate appropriate soil binders to be used.
- A soil binder should be environmentally benign (non-toxic to plant and animal life), easy to apply, easy to maintain, economical, and should not stain paved or painted surfaces. Soil binders should not pollute storm water.
- Some soil binders may not be compatible with existing vegetation.
- Performance of soil binders depends on temperature, humidity, and traffic across treated areas.
- Avoid over spray onto roads, sidewalks, drainage channels, existing vegetation, etc.

Selecting a Soil Binder

Properties of common soil binders used for erosion control are provided on the table at the end of this BMP. Use this table to select an appropriate soil binder. Refer to WE-1, Wind Erosion Control, for dust control soil binders.

Factors to consider when selecting a soil binder include the following:

- Suitability to situation - Consider where the soil binder will be applied, if it needs a high resistance to leaching or abrasion, and whether it needs to be compatible with any existing vegetation. Determine the length of time soil stabilization will be needed, and if the soil binder will be placed in an area where it will degrade rapidly. In general, slope steepness is not a discriminating factor for the listed soil binders;
- Soil types and surface materials - Fines and moisture content are key properties of surface materials. Consider a soil binder's ability to penetrate, likelihood of leaching, and ability to form a surface crust on the surface materials; and
- Frequency of application - The frequency of application can be affected by subgrade conditions, surface type, climate, and maintenance schedule. Frequent applications could lead to high costs. Application frequency may be minimized if the soil binder has good penetration, low evaporation, and good longevity. Consider also that frequent application will require frequent equipment clean up.

Plant-Material Based (Short Lived) Binders

Guar: Guar is a non-toxic, biodegradable, natural galactomannan (or plant carbohydrates/sugars) based hydrocolloid treated with dispersant agents for easy field mixing. It should be mixed with

water at the rate of 11 to 15 lb per 1,000 gallons. Recommended minimum application rates are as follows:

Application rates for Guar Soil Stabilizer

Slope (H:V):	Flat	4:1	3:1	2:1	1:1
lb/acre:	40	45	50	60	70

Psyllium: Psyllium is composed of the finely ground muciloid coating of seeds (from plantago plant) that is applied as a dry powder or in a wet slurry to the surface of the soil. It dries to form a firm but rewettable membrane that binds soil particles together but permits germination and growth of seed. Psyllium requires 12 to 18 hours drying time. Application rates should be from 80 to 200 lb/acre, with enough water in solution to allow for a uniform slurry flow.

Starch: Starch is non-ionic, cold water soluble (pre-gelatinized) granular cornstarch. The material is mixed with water and applied at the rate of 150 lb/acre. Approximate drying time is 9 to 12 hours.

Plant-Material Based (Long Lived) Binders

Pitch and Rosin Emulsion: Generally, a non-ionic pitch and rosin emulsion has a minimum solids content of 48%. The rosin should be a minimum of 26% of the total solids content. The soil stabilizer should be non-corrosive, water dilutable emulsion that upon application cures to a water insoluble binding and cementing agent. For soil erosion control applications, the emulsion is diluted and should be applied as follows:

- For clayey soil: 5 parts water to 1 part emulsion, and
- For sandy soil: 10 parts water to 1 part emulsion.

Application can be by water truck or hydraulic seeder with the emulsion and product mixture applied at the rate specified by the manufacturer.

Polymeric Emulsion Blend Binders

Acrylic Copolymers and Polymers: Polymeric soil stabilizers should consist of a liquid or solid polymer or copolymer with an acrylic base that contains a minimum of 55% solids. The polymeric compound should be handled and mixed in a manner that will not cause foaming or should contain an anti-foaming agent. The polymeric emulsion should not exceed its shelf life or expiration date; manufacturers should provide the expiration date. Polymeric soil stabilizer should be readily miscible in water, non-injurious to seed or animal life, non-flammable, should provide surface soil stabilization for various soil types without totally inhibiting water infiltration, and should not re-emulsify when cured. The applied compound should air cure within a maximum of 36 to 48 hours. Liquid copolymer should be diluted at a rate of 10 parts water to 1 part polymer and the mixture applied to soil at a rate of 1,175 gallons/acre.

Liquid Polymers of Methacrylates and Acrylates: This material consists of a tackifier/sealer that is a liquid polymer of methacrylates and acrylates. It is an aqueous 100% acrylic emulsion blend of 40% solids by volume that is free from styrene, acetate, vinyl, ethoxylated surfactants or silicates. For soil stabilization applications, it is diluted with water in accordance with manufacturer's recommendations, and applied with a hydraulic seeder at the rate of 20 gallons/acre. Drying time is 12 to 18 hours after application.

Copolymers of Sodium Acrylates and Acrylamides: These materials are non-toxic, dry powders that are copolymers of sodium acrylate and acrylamide. They are mixed with water and applied to the soil surface for erosion control at rates that are determined by slope gradient:

Slope Gradient (H:V)	lb/acre
Flat to 5:1	3.0-5.0
5:1 to 3:1	5.0-10.0
2:2 to 1:1	10.0-20.0

Poly-Acrylamide and Copolymer of Acrylamide: Linear copolymer polyacrylamide is packaged as a dry flowable solid. When used as a standalone stabilizer, it is diluted at a rate of 1 lb/1,000 gal of water and applied at the rate of 5.0 lb/acre.

Hydro-Colloid Polymers: Hydro-Colloid Polymers are various combinations of dry flowable poly-acrylamides, copolymers and hydro-colloid polymers that are mixed with water and applied to the soil surface at rates of 55 to 60 lb/acre. Drying times are 0 to 4 hours.

Cementitious-Based Binders

Gypsum: This is a formulated gypsum based product that readily mixes with water and mulch to form a thin protective crust on the soil surface. It is composed of high purity gypsum that is ground, calcined and processed into calcium sulfate hemihydrate with a minimum purity of 86%. It is mixed in a hydraulic seeder and applied at rates 4,000 to 12,000 lb/acre. Drying time is 4 to 8 hours.

Applying Soil Binders

After selecting an appropriate soil binder, the untreated soil surface should be prepared before applying the soil binder. The untreated soil surface should contain sufficient moisture to assist the agent in achieving uniform distribution. In general, the following steps should be followed:

- Follow manufacturer's written recommendations for application rates, pre-wetting of application area, and cleaning of equipment after use;
- Prior to application, roughen embankment and fill areas;
- Consider the drying time for the selected soil binder and apply with sufficient time before anticipated rainfall. Soil binders should not be applied during or immediately before rainfall;
- Avoid over spray onto roads, sidewalks, drainage channels, sound walls, existing vegetation, etc.;
- Soil binders should not be applied to areas with standing water, under rainy conditions, or when the temperature is below 40°F during the curing period;
- More than one treatment is often necessary, although the second treatment may be diluted or have a lower application rate;
- Generally, soil binders require a minimum curing time of 24 hours before they are fully effective. Refer to manufacturer's instructions for specific cure time; and
- For liquid agents:
 - Crown or slope ground to avoid ponding;

- Uniformly pre-wet ground at 0.03 to 0.3 gal/yd² or according to manufacturer’s recommendations;
- Apply solution under pressure. Overlap solution 6 to 12 in.;
- Allow treated area to cure for the time recommended by the manufacturer; typically at least 24 hours;
- Apply second treatment before first treatment becomes ineffective, using 50% application rate; and
- In low humidities, reactivate chemicals by re-wetting with water at 0.1 to 0.2 gal/yd².

Costs

Costs vary according to the soil stabilizer selected for implementation. The following are approximate costs in California:

Soil Binder	Cost per Acre
Plant-Material Based (Short Lived) Binders	\$400
Plant-Material Based (Long Lived) Binders	\$1,200
Polymeric Emulsion Blend Binders	\$400 ⁽¹⁾
Cementitious-Based Binders	\$800

⁽¹⁾ \$1,200 for Acrylic polymers and copolymers

Source: Caltrans guidance for Soil Stabilization for Temporary Slopes, Nov. 1999

Note that Hawaii’s unit prices are higher than California’s unit prices.

Inspection and Maintenance

- Inspect BMPs prior to forecast rain, daily during extended rain events, after rain events, weekly during the rainy season, and at two-week intervals during the non-rainy season.
- Areas where erosion is evident should be repaired and BMPs re-applied as soon as possible. Care should be exercised to minimize the damage to protected areas while making repairs, as any area damaged will require re-application of BMPs.
- Reapply the selected soil binder as needed to maintain effectiveness.

References

California Stormwater Quality Association (CASQA) Best Management Practices Handbook Construction, 2003.

Guidance Document: Soil Stabilization for Temporary Slopes, State of California Department of Transportation (Caltrans), November 1999.

Sedimentation and Erosion Control, An Inventory of Current Practices Draft, USEPA, April 1990.

Stormwater Quality Handbooks Construction Site Best Management Practices (BMPs) Manual, State of California Department of Transportation (Caltrans), November 2000.

Stormwater Management for Construction Activities, Developing Pollution Prevention Plans and Best Management Practices, EPA 832-R-92005; USEPA, April 1992.

Properties of Soil Binders for Erosion Control

Evaluation Criteria	Binder Type			
	Plant Material Based (Short Lived)	Plant Material Based (Long Lived)	Polymeric Emulsion Blends	Cementitious-Based Binders
Relative Cost	Low	Low	Low	Low
Resistance to Leaching	High	High	Low to Moderate	Moderate
Resistance to Abrasion	Moderate	Low	Moderate to High	Moderate to High
Longevity	Short to Medium	Medium	Medium to Long	Medium
Minimum Curing Time before Rain	9 to 18 hours	19 to 24 hours	0 to 24 hours	4 to 8 hours
Compatibility with Existing Vegetation	Good	Poor	Poor	Poor
Mode of Degradation	Biodegradable	Biodegradable	Photodegradable/ Chemically Degradable	Photodegradable/ Chemically Degradable
Labor Intensive	No	No	No	No
Specialized Application Equipment	Water Truck or Hydraulic Mulcher	Water Truck or Hydraulic Mulcher	Water Truck or Hydraulic Mulcher	Water Truck or Hydraulic Mulcher
Liquid/Powder	Powder	Liquid	Liquid/Powder	Powder
Surface Crusting	Yes, but dissolves on rewetting	Yes	Yes, but dissolves on rewetting	Yes
Clean Up	Water	Water	Water	Water
Erosion Control Application Rate	Varies ⁽¹⁾	Varies ⁽¹⁾	Varies ⁽¹⁾	4,000 to 12,000 lbs./acre

⁽¹⁾ See Implementation for specific rates.

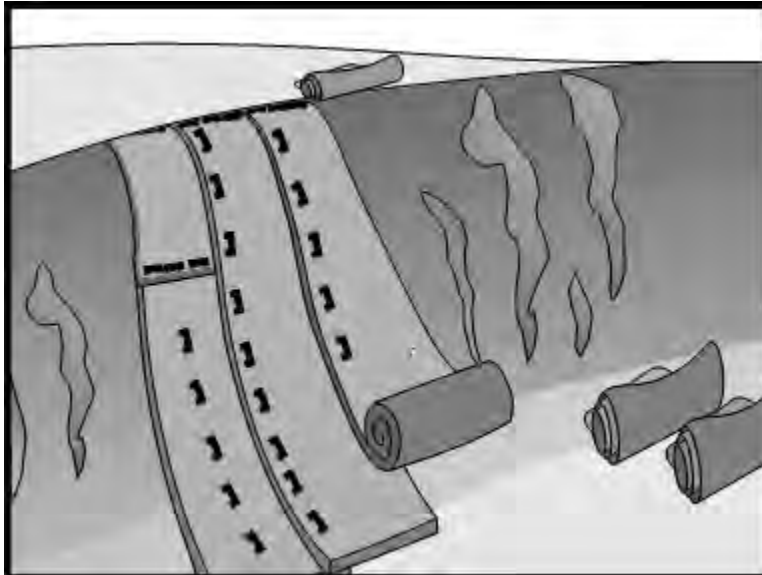

Description and Purpose

Mattings of natural materials are used to cover the soil surface to reduce erosion from rainfall impact, hold soil in place, and absorb and hold moisture near the soil surface. Additionally, matting may be used to stabilize soils until vegetation is established.

Suitable Applications

Mattings are commonly applied on short, steep slopes where erosion hazard is high and vegetation will be slow to establish. Mattings are also used on stream banks where moving water at velocities between 3 ft/s and 6 ft/s are likely to wash out new vegetation and in areas where the soil surface is disturbed and where existing vegetation has been removed. Matting may also be used when seeding cannot occur (e.g., late season construction and/or the arrival of an early rain season). Erosion control matting should be considered when the soils are fine grained and potentially erosive. These measures should be considered in the following situations:

- Steep slopes, generally steeper than 3:1 (H:V);
- Slopes where the erosion potential is high;
- Slopes and disturbed soils where mulch should be anchored;
- Disturbed areas where plants are slow to develop;
- Channels with flows exceeding 3.3 ft/s;
- Channels to be vegetated;
- Stockpiles; and
- Slopes adjacent to water bodies of Environmentally Sensitive Areas.

Objectives

EC – Erosion Control	√
SE – Sediment Control	
TR – Tracking Control	
WE – Wind Erosion Control	▲
NS – Non-Storm Water Management Control	
WM – Waste Management & Materials Pollution Control	

Legend:

- √ Primary Objective
- ▲ Secondary Objective

Targeted Constituents

Sediment	√
Nutrients	
Trash	
Metals	
Bacteria	
Oil and Grease	
Organics	

Potential Alternatives

EC-3 Hydraulic Mulch
EC-4 Hydroseeding
EC-5 Soil Binders
EC-8 Wood Mulching

Limitations

- Properly installed mattings provide excellent erosion control but do so at relatively high cost. This high cost typically limits the use of mattings to areas of concentrated channel flow and steep slopes.
- Mattings are more costly than other BMP practices, limiting their use to areas where other BMPs are ineffective (e.g. channels, steep slopes).
- Installation is critical and requires experienced contractors. The contractor should install the matting material in such a manner that continuous contact between the material and the soil occurs.
- Geotextiles and mats may delay seed germination, due to reduction in soil temperature.
- Blankets and mats are generally not suitable for excessively rocky sites or areas where the final vegetation will be mowed (since staples and netting can catch in mowers).
- Blankets and mats should be removed and disposed of prior to application of permanent soil stabilization measures.
- Plastic sheeting is easily vandalized, easily torn, photodegradable, and should be disposed of at a landfill.
- Plastic results in 100% runoff, which may cause serious erosion problems in the areas receiving the increased flow.
- The use of plastic should be limited to covering stockpiles or very small graded areas for short periods of time (such as through one imminent storm event) until alternative measures, such as seeding and mulching, may be installed.
- Geotextiles, mats, plastic covers, and erosion control covers have maximum flow rate limitations; consult the manufacturer for proper selection.
- Not suitable for areas that have heavy foot traffic (tripping hazard) - e.g., pad areas around buildings under construction.

Implementation

Material Selection

Organic matting materials have been found to be effective where re-vegetation will be provided by re-seeding. The choice of matting should be based on the size of area, side slopes, and surface conditions such as hardness, moisture, weed growth, and availability of materials.

The following natural and synthetic mattings are commonly used:

Plastic Covers

- Plastic sheeting should have a minimum thickness of 6 mils, and should be keyed in at the top of slope and firmly held in place with sandbags or other weights placed no more than 10 ft. apart. Seams are typically taped or weighted down their entire length, and there should be at least a 12 in. to 24 in. overlap of all seams. Edges should be embedded a minimum of 6 in. in soil.
- All sheeting should be inspected periodically after installation and after significant rainstorms to check for erosion, undermining, and anchorage failure. Any failures should be repaired immediately. If washout or breakages occur, the material should be re-installed after repairing the damage to the slope.

Geotextiles

- Material should be a woven polypropylene fabric with minimum thickness of 0.06 in., minimum width of 12 ft. and should have minimum tensile strength of 150 lbs. (warp); 80 lbs. (fill) in conformance with the requirements in ASTM Designation: D4632. The permittivity of the fabric should be approximately 0.07 sEC-0 in conformance with the requirements in ASTM Designation: D4491. The fabric should have an ultraviolet (UV) stability of 70 percent in conformance with the requirements in ASTM designation: D4355. Geotextile blankets must be secured in place with wire staples or sandbags and by keying into tops of slopes to prevent infiltration of surface waters under geotextile. Staples should be made of minimum 11 gauge steel wire and should be U-shaped with 8 in. legs and 2 in. crown.
- Geotextiles may be reused if they are suitable for the use intended.

Erosion Control Blankets/Mats

- Biodegradable rolled erosion control products (RECPs) are typically composed of jute fibers, curled wood fibers, straw, coconut fiber, or a combination of these materials. In order for an RECP to be considered 100% biodegradable, the netting, sewing or adhesive system that holds the biodegradable mulch fibers together should also be biodegradable.
 - **Jute** is a natural fiber that is made into a yarn that is loosely woven into a biodegradable mesh. It is designed to be used in conjunction with vegetation and has longevity of approximately one year. The material is supplied in rolled strips, which should be secured to the soil with U-shaped staples or stakes in accordance with manufacturers' recommendations.
 - **Excelsior** (curled wood fiber) blanket material should consist of machine produced mats of curled wood excelsior with 80 percent of the fiber 6 in. or longer. The excelsior blanket should be of consistent thickness. The wood fiber should be evenly distributed over the entire area of the blanket. The top surface of the blanket should be covered with a photodegradable extruded plastic mesh. The blanket should be smolder resistant without the use of chemical additives and should be non-toxic and non-injurious to plant and animal life. Excelsior blankets should be furnished in rolled strips, a minimum of 48 in. wide, and should have an average weight of 0.8 lb/yd², ±10 percent, at the time of manufacture. Excelsior blankets must be secured in place with wire staples. Staples should be made of minimum 11 gauge steel wire and should be U-shaped with 8 in. legs and 2 in. crown.
 - **Straw blanket** should be machine produced mats of straw with a lightweight biodegradable netting top layer. The straw should be attached to the netting with biodegradable thread or glue strips. The straw blanket should be of consistent thickness. The straw should be evenly distributed over the entire area of the blanket. Straw blanket should be furnished in rolled strips a minimum of 6.5 ft. wide, a minimum of 80 ft. long and a minimum of 0.5 lb/yd². Straw blankets must be secured in place with wire staples. Staples should be made of minimum 11 gauge steel wire and should be U-shaped with 8 in. legs and 2 in. crown.
 - **Wood fiber blanket** is composed of biodegradable fiber mulch with extruded plastic netting held together with adhesives. The material is designed to enhance re-vegetation. The material is furnished in rolled strips, which must be secured to the

- ground with U-shaped staples or stakes in accordance with manufacturers' recommendations.
- **Coconut fiber blanket** should be a machine produced mat of 100 percent coconut fiber with biodegradable netting on the top and bottom. The coconut fiber should be attached to the netting with biodegradable thread or glue strips. The coconut fiber blanket should be of consistent thickness. The coconut fiber should be evenly distributed over the entire area of the blanket. Coconut fiber blanket should be furnished in rolled strips with a minimum of 6.5 ft. wide, a minimum of 80 ft. long and a minimum of 0.5 lb/yd². Coconut fiber blankets must be secured in place with wire staples. Staples should be made of minimum 11 gauge steel wire and should be U-shaped with 8 in. legs and 2 in. crown.
 - **Coconut fiber mesh** is a thin permeable membrane made from coconut or corn fiber that is spun into a yarn and woven into a biodegradable mat. It is designed to be used in conjunction with vegetation and typically has longevity of several years. The material is supplied in rolled strips, which must be secured to the soil with U-shaped staples or stakes in accordance with manufacturers' recommendations.
 - **Straw coconut fiber blanket** should be machine produced mats of 70 percent straw and 30 percent coconut fiber with a biodegradable netting top layer and a biodegradable bottom net. The straw and coconut fiber should be attached to the netting with biodegradable thread or glue strips. The straw coconut fiber blanket should be of consistent thickness. The straw and coconut fiber should be evenly distributed over the entire area of the blanket. Straw coconut fiber blanket should be furnished in rolled strips a minimum of 6.5 ft. wide, a minimum of 80 ft. long and a minimum of 0.5 lb/yd². Straw coconut fiber blankets must be secured in place with wire staples. Staples should be made of minimum 11 gauge steel wire and should be U-shaped with 8 in. legs and 2 in. crown.
 - Non-biodegradable RECPs are typically composed of polypropylene, polyethylene, nylon or other synthetic fibers. In some cases, a combination of biodegradable and synthetic fibers is used to construct the RECP. Netting used to hold these fibers together is typically non-biodegradable as well.
 - **Plastic netting** is a lightweight biaxially oriented netting designed for securing loose mulches like straw or paper to soil surfaces to establish vegetation. The netting is photodegradable. The netting is supplied in rolled strips, which must be secured with U-shaped staples or stakes in accordance with manufacturers' recommendations.
 - **Plastic mesh** is an open weave geotextile that is composed of an extruded synthetic fiber woven into a mesh with an opening size of less than ¼ in. It is used with re-vegetation or may be used to secure loose fiber such as straw to the ground. The material is supplied in rolled strips, which must be secured to the soil with U-shaped staples or stakes in accordance with manufacturers' recommendations.
 - **Synthetic fiber with netting** is a mat that is composed of durable synthetic fibers treated to resist chemicals and ultraviolet light. The mat is a dense; three dimensional mesh of synthetic (typically polyolefin) fibers stitched between two polypropylene nets. The mats are designed to be re-vegetated and provide a permanent composite system of soil, roots, and geomatrix. The material is furnished in rolled strips, which

- must be secured with U-shaped staples or stakes in accordance with manufacturers' recommendations.
- **Bonded synthetic fibers** consist of a three dimensional geomatrix nylon (or other synthetic) matting. Typically it has more than 90 percent open area, which facilitates root growth. It's tough root reinforcing system anchors vegetation and protects against hydraulic lift and shear forces created by high volume discharges. It can be installed over prepared soil, followed by seeding into the mat. Once vegetated, it becomes an invisible composite system of soil, roots, and geomatrix. The material is furnished in rolled strips that must be secured with U-shaped staples or stakes in accordance with manufacturers' recommendations.
 - **Combination synthetic and biodegradable RECPs** consist of biodegradable fibers, such as wood fiber or coconut fiber, with a heavy polypropylene net stitched to the top and a high strength continuous filament geomatrix or net stitched to the bottom. The material is designed to enhance re-vegetation. The material is furnished in rolled strips, which must be secured with U-shaped staples or stakes in accordance with manufacturers' recommendations.

Site Preparation

- Proper site preparation is essential to ensure complete contact of the blanket or matting with the soil.
- Grade and shape the area of installation.
- Remove all rocks, clods, vegetation or other obstructions so that the installed blankets or mats will have complete, direct contact with the soil.
- Prepare seedbed by loosening 2 to 3 in. of topsoil.

Seeding

Seeding after mat installation is often specified for turf reinforcement application. When seeding prior to blanket installation, all check slots and other areas disturbed during installation should be re-seeded. Where soil filling is specified, seed the matting and the entire disturbed area after installation and prior to filling the mat with soil.

Fertilize and seed in accordance with seeding specifications or other types of landscaping plans. When using jute matting on a seeded area, apply approximately half the seed before laying the mat and the remainder after laying the mat. The protective matting can be laid over areas where grass has been planted and the seedlings have emerged. Where vines or other ground covers are to be planted, lay the protective matting first and then plant through matting according to design of planting.

Check Slots

Check slots are made of glass fiber strips, excelsior matting strips or tight folded jute matting blanket or strips for use on steep, highly erodible watercourses. The check slots are placed in narrow trenches 6 to 12 in. deep across the channel and left flush with the soil surface. They are to cover the full cross section of designed flow.

Laying and Securing Matting

- Before laying the matting, all check slots should be installed and the friable seedbed made free from clods, rocks, and roots. The surface should be compacted and finished according to the requirements of the manufacturer's recommendations.
- Mechanical or manual lay down equipment should be capable of handling full rolls of fabric and laying the fabric smoothly without wrinkles or folds. The equipment should meet the fabric manufacturer's recommendations or equivalent standards.

Anchoring

- U-shaped wire staples, metal geotextile stake pins, or triangular wooden stakes can be used to anchor mats and blankets to the ground surface.
- Wire staples should be made of minimum 11 gauge steel wire and should be U-shaped with 8 in. legs and 2 in. crown.
- Metal stake pins should be 0.188 in. diameter steel with a 1.5 in. steel washer at the head of the pin, and 8 in. in length.
- Wire staples and metal stakes should be driven flush to the soil surface.

Installation on Slopes

Installation should be in accordance with the manufacturer's recommendations. In general, these will be as follows:

- Begin at the top of the slope and anchor the blanket in a 6 in. deep by 6 in. wide trench. Backfill trench and tamp earth firmly;
- Unroll blanket down slope in the direction of water flow;
- Overlap the edges of adjacent parallel rolls 2 to 3 in. and staple every 3 ft.;
- When blankets should be spliced, place blankets end over end (shingle style) with 6 in. overlap. Staple through overlapped area, approximately 12 in. apart;
- Lay blankets loosely and maintain direct contact with the soil. Do not stretch; and
- Staple blankets sufficiently to anchor blanket and maintain contact with the soil. Staples should be placed down the center and staggered with the staples placed along the edges. Steep slopes, 1:1 (H:V) to 2:1 (H:V), require a minimum of 2 staples/yd². Moderate slopes, 2:1 (H:V) to 3:1 (H:V), require a minimum of 1 ½ staples/yd².

Installation in Channels

Installation should be in accordance with the manufacturer's recommendations. In general, these will be as follows:

- Dig initial anchor trench 12 in. deep and 6 in. wide across the channel at the lower end of the project area;
- Excavate intermittent check slots, 6 in. deep and 6 in. wide across the channel at 25 to 30 ft. intervals along the channels;
- Cut longitudinal channel anchor trenches 4 in. deep and 4 in. wide along each side of the installation to bury edges of matting, whenever possible extend matting 2 to 3 in. above the crest of the channel side slopes;

- Beginning at the downstream end and in the center of the channel, place the initial end of the first roll in the anchor trench and secure with fastening devices at 12 in. intervals. Note: matting will initially be upside down in anchor trench;
- In the same manner, position adjacent rolls in anchor trench, overlapping the preceding roll a minimum of 3 in;
- Secure these initial ends of mats with anchors at 12 in. intervals, backfill and compact soil;
- Unroll center strip of matting upstream. Stop at next check slot or terminal anchor trench. Unroll adjacent mats upstream in similar fashion, maintaining a 3 in. overlap;
- Fold and secure all rolls of matting snugly into all transverse check slots. Lay mat in the bottom of the slot then fold back against itself. Anchor through both layers of mat at 12 in. intervals, then backfill and compact soil. Continue rolling all mat widths upstream to the next check slot or terminal anchor trench;
- Alternate method for non-critical installations: Place two rows of anchors on 6 in. centers at 25 to 30 ft. intervals in lieu of excavated check slots;
- Staple shingled lap spliced ends a minimum of 12 in. apart on 12 in. intervals;
- Place edges of outside mats in previously excavated longitudinal slots; anchor using prescribed staple pattern, backfill, and compact soil;
- Anchor, fill, and compact upstream end of mat in a 12 in. by 6 in. terminal trench;
- Secure mat to ground surface using U-shaped wire staples, geotextile pins, or wooden stakes; and
- Seed and fill turf reinforcement matting with soil, if specified.

Soil Filling (if specified for turf reinforcement)

- Always consult the manufacturer's recommendations for installation.
- Do not drive tracked or heavy equipment over mat.
- Avoid any traffic over matting if loose or wet soil conditions exist.
- Use shovels, rakes, or brooms for fine grading and touch up.
- Smooth out soil filling just exposing top netting of mat.

Temporary Soil Stabilization Removal

- Temporary soil stabilization removed from the site of the work should be disposed of if necessary.

Costs

Relatively high compared to other BMPs. Biodegradable materials: \$0.50 - \$0.57/yd². Permanent materials: \$3.00 - \$4.50/yd². Staples: \$0.04 - \$0.05/staple. Approximate costs for installed materials are shown below:

Rolled Erosion Control Products		Installed Cost per Acre
Biodegradable	Jute Mesh	\$6,500
	Curled Wood Fiber	\$10,500
	Straw	\$8,900
	Wood Fiber	\$8,900
	Coconut Fiber	\$13,000
	Coconut Fiber Mesh	\$31,200
	Straw Coconut Fiber	\$10,900
Non-Biodegradable	Plastic Netting	\$2,000
	Plastic Mesh	\$3,200
	Synthetic Fiber with Netting	\$34,800
	Bonded Synthetic Fibers	\$50,000
	Combination with Biodegradable	\$32,000

Source: Caltrans Guidance for Soil Stabilization for Temporary Slopes, Nov. 1999

Note that Hawaii's unit prices are higher than California's unit prices.

Inspection and Maintenance

- Inspect BMPs prior to forecast rain, daily during extended rain events, after rain events, weekly during the rainy season, and at two-week intervals during the non-rainy season, and at two-week intervals during the non-rainy season.
- Inspect BMPs subject to non-storm water discharges daily while non-storm water discharges occur.
- Areas where erosion is evident should be repaired and BMPs reapplied as soon as possible. Care should be exercised to minimize the damage to protected areas while making repairs, as any area damaged will require reapplication of BMPs.
- If washout or breakage occurs, re-install the material after repairing the damage to the slope or channel.
- Make sure matting is uniformly in contact with the soil.
- Check that all the lap joints are secure.
- Check that staples are flush with the ground.
- Check that disturbed areas are seeded.

References

California Stormwater Quality Association (CASQA) Best Management Practices Handbook Construction, 2003.

Guidance Document: Soil Stabilization for Temporary Slopes, State of California Department of Transportation (Caltrans), November 1999.

Guides for Erosion and Sediment Controls in California, USDA Soils Conservation Service, January 1991.

National Management Measures to Control Nonpoint Source Pollution from Urban Areas, United States Environmental Protection Agency, 2002.

Stormwater Management of the Puget Sound Basin, Technical Manual, Publication #91-75, Washington State Department of Ecology, February 1992.

Stormwater Quality Handbooks Construction Site Best Management Practices (BMPs) Manual, State of California Department of Transportation (Caltrans), November 2000.

Water Quality Management Plan for The Lake Tahoe Region, Volume II, Handbook of Management Practices, Tahoe Regional Planning Agency, November 1988.

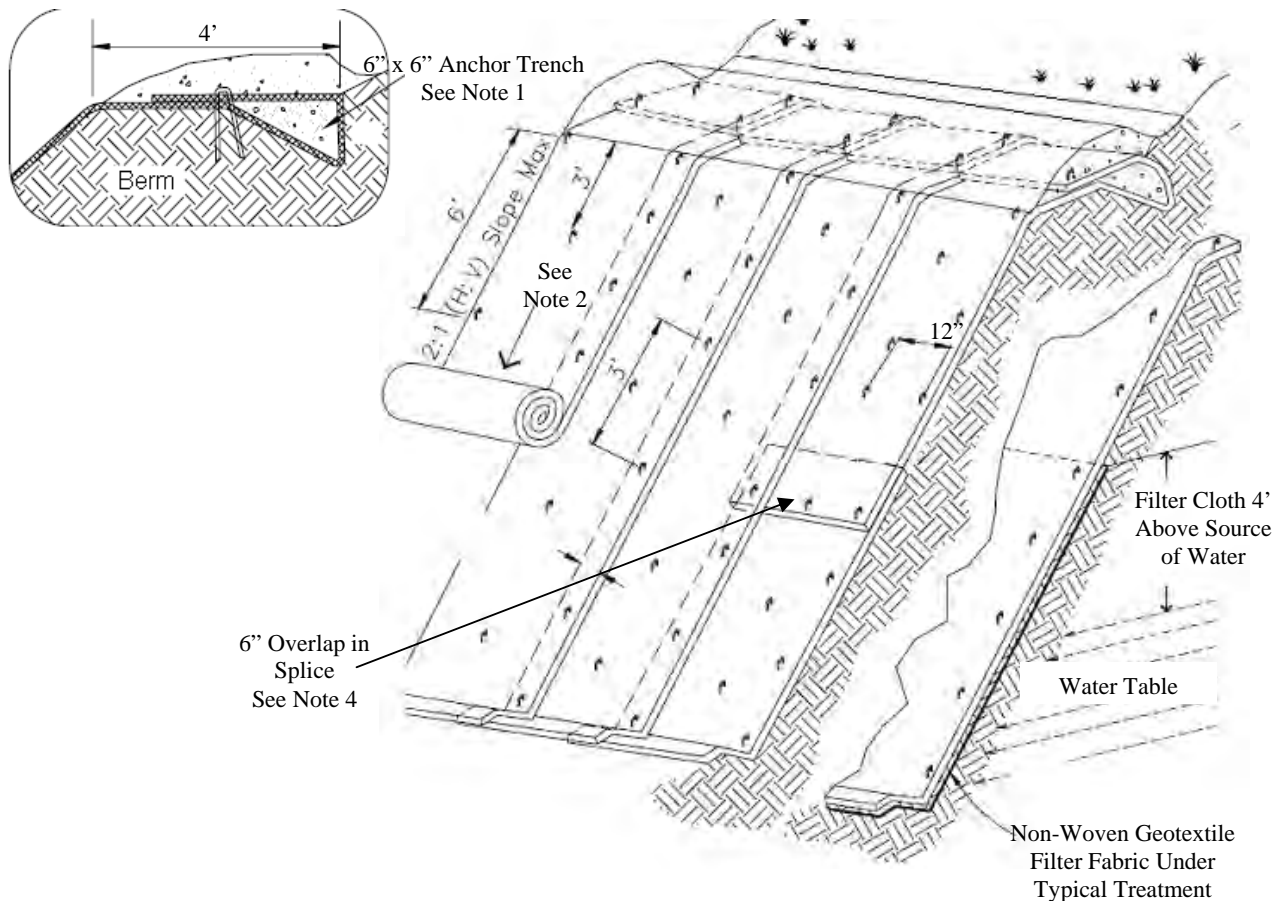

Detail "A"

Not to Scale

Notes:

1. Begin at the top of the slope and anchor the blanket in a 6 in. deep by 6 in. wide trench. Backfill trench and tamp earth firmly.
2. Unroll blanket down slope in the direction of water flow.
3. Overlap the edges of adjacent parallel rolls 2 to 3 in. and staple every 3 ft.
4. When blankets should be spliced, place blankets end over end (shingle style) with 6 in. overlap. Staple through overlapped area, approximately 12 in. apart.
5. Lay blankets loosely and maintain direct contact with the soil. Do not stretch.
6. Staple blankets sufficiently to anchor blanket and maintain contact with the soil. Staples should be placed down the center and staggered with the staples placed along the edges.
7. Steep slopes, 1:1 (H:V) to 2:1 (H:V), require a minimum of 2 staples/yd². Moderate slopes, 2:1 (H:V) to 3:1 (H:V), require a minimum of 1½ staples/yd².
8. Install per manufacturer's recommendations.
9. For Limitations, Geotextiles and Plastic Covers Specifications, Types of Erosion Control Blankets/Mats, and Site Preparations see EC-7.

Typical Slope Soil Stabilization

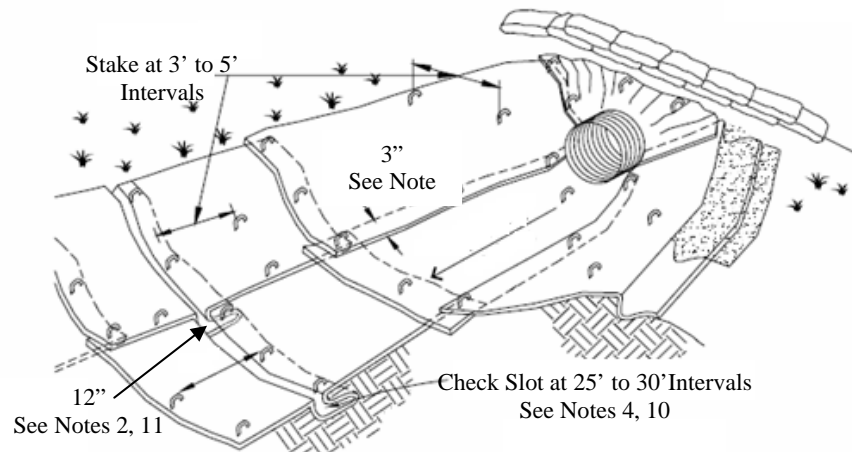

Detail "B"

Isometric View, Not to Scale

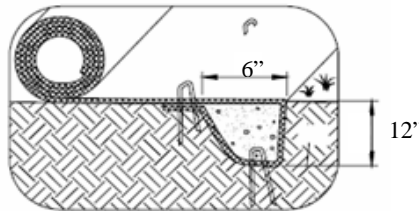

Initial Channel Anchor Trench
Not to Scale
See Note 3

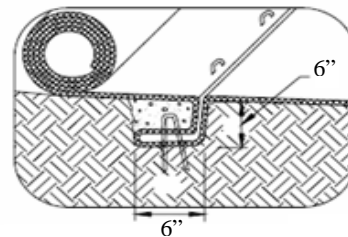

Intermittent Check Slot
Not to Scale

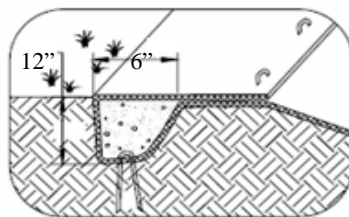

Terminal Slope and Channel Anchor Trench
Not to Scale
See Note 3

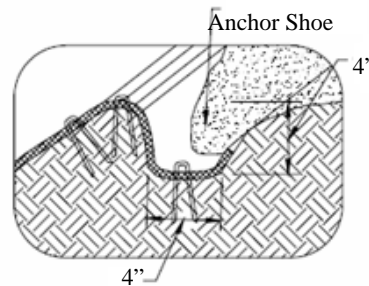

Longitudinal Anchor Trench
Not to Scale
See Note 5

Notes:

1. Install per manufacturer's recommendations.
2. Secure these initial ends of mats with anchors at 12 in. intervals, backfill and compact soil.
3. Dig initial anchor trench 12 in. deep and 6 in. wide across the channel at the lower end of the project area and at terminal slope.
4. Excavate intermittent check slots, 6 in. deep and 6 in. wide across the channel at 25 to 30 ft intervals along the channels.
5. Cut longitudinal channel anchor trenches 4 in. deep and 4 in. wide along each side of the installation to bury edges of matting, whenever possible extend matting 2 to 3 in. above the crest of the channel side slopes.
6. Beginning at the downstream end and in the center of the channel, place the initial end of the first roll in the anchor trench and secure with fastening devices at 12 in. intervals. Note: matting will initially be upside down in anchor trench.
7. In the same manner, position adjacent rolls in anchor trench, overlapping the preceding roll a minimum of 3 in.
8. Unroll center strip of matting upstream. Stop at next check slot or terminal anchor trench. Unroll adjacent mats upstream in similar fashion, maintaining a 3 in. overlap.
9. Fold and secure all rolls of matting snugly into all transverse check slots. Lay mat in the bottom of the slot then fold back against itself. Anchor through both layers of mat at 12 in. intervals, then backfill and compact soil. Continue rolling all mat widths upstream to the next check slot or terminal anchor trench.
10. Alternate method for non-critical installations: Place two rows of anchors on 6 in. centers at 25 to 30 ft. intervals in lieu of excavated check slots.
11. Staple shingled lap spliced ends a minimum of 12 in. apart on 12 in. intervals.
12. Place edges of outside mats in previously excavated longitudinal slots; anchor using prescribed staple pattern, backfill, and compact soil.
13. Anchor, fill, and compact upstream end of mat in a 12 in. by 6 in. terminal trench.
14. Secure mat to ground surface using U-shaped wire staples, geotextile pins, or wooden stakes.
15. Seed and fill turf reinforcement matting with soil, if specified.
16. For Limitations, Geotextiles and Plastic Covers Specifications, Types of Erosion Control Blankets/Mats, and Site Preparations see EC-7.

Typical Soil Stabilization in Channels



Description and Purpose

Wood mulching consists of applying a mixture of shredded wood mulch, bark or compost to disturbed soils. The primary function of wood mulching is to reduce erosion by protecting bare soil from rainfall impact, increasing infiltration, and reducing runoff.

Suitable Applications

Wood mulching is suitable for disturbed soil areas requiring temporary protection until permanent stabilization is established.

Limitations

- Not suitable for use on slopes steeper than 3:1 (H:V). Best suited to flat areas or gentle slopes or 5:1 (H:V) or flatter.
- Wood mulch and compost may introduce unwanted species.
- Not suitable for areas exposed to concentrated flows. Wood mulch produced from a tub type grinder interlocks with adjacent fibers and the mix is more resistant to concentrated flows compared to wood chips.
- May need to be removed prior to further earthwork.

Implementation

Mulch Selection

There are many types of mulches. Selection of the appropriate type of mulch should be based on the type of application, site conditions, and compatibility with planned or future uses.

Objectives

- EC – Erosion Control ✓
- SE – Sediment Control
- TR – Tracking Control
- WE – Wind Erosion Control ▲
- NS – Non-Storm Water Management Control
- WM – Waste Management & Materials Pollution Control

Legend:

- ✓ Primary Objective
- ▲ Secondary Objective

Targeted Constituents

- Sediment ✓
- Nutrients
- Trash
- Metals
- Bacteria
- Oil and Grease
- Organics

Potential Alternatives

- EC-3 Hydraulic Mulch
- EC-4 Hydroseeding
- EC-5 Soil Binders
- EC-7 Geotextiles and Mats

Application Procedures

Prior to application, after existing vegetation has been removed, roughen embankment and fill areas by rolling with a device such as a punching type roller or by track walking. The construction application procedures for mulches vary significantly depending upon the type of mulching method specified. Two methods are highlighted here:

- **Green Material:** This type of mulch is produced by the recycling of vegetation trimmings such as grass, shredded shrubs, and trees. Methods of application are generally by hand although pneumatic methods are available:
 - As a temporary ground cover with or without seeding; and/or
 - Should be evenly distributed on site to a depth of not more than 2 in.
- **Shredded Wood:** Suitable for ground cover in ornamental or revegetated plantings.
 - Shredded wood/bark is conditionally suitable. See note under limitations;
 - Distribute by hand or use pneumatic methods;
 - Evenly distribute the mulch across the soil surface to a depth of 2 to 3 in; and
 - Sites which will include the demolition of large quantities of trees should consider the use of shredded wood covers as a temporary erosion control measure.
- Avoid mulch placement onto roads, sidewalks, drainage channels, existing vegetation, etc.

Costs

Average annual cost for installation and maintenance (3-4 months useful life) is around \$4,000 per acre, but cost can increase if the source is not close to the project site in California. Note that Hawaii's unit prices are higher than California's unit prices.

Inspection and Maintenance

- Inspect BMPs prior to forecast rain, daily during extended rain events, after rain events, weekly during the rainy season, and at two-week intervals during the non-rainy season.
- Areas where erosion is evident should be repaired and BMPs reapplied as soon as possible. Care should be exercised to minimize the damage to protected areas while making repairs, as any area damaged will require reapplication of BMPs.

Regardless of the mulching technique selected, the key consideration in inspection and maintenance is that the mulch needs to last long enough to achieve erosion control objectives. If the mulch is applied as a standalone erosion control method over disturbed areas (without seed), it should last the length of time the site will remain barren or until final re-grading and revegetation.

- Where vegetation is not the ultimate cover, such as ornamental and landscape applications of bark or wood chips, inspection and maintenance should focus on longevity and integrity of the mulch.
- Reapply mulch when bare earth becomes visible.

References

California Stormwater Quality Association (CASQA) Best Management Practices Handbook Construction, 2003.

Controlling Erosion of Construction Sites Agriculture Information Bulletin #347, U.S. Department of Agriculture (USDA), Natural Resources Conservation Service (NRCS) (formerly Soil Conservation Service – SCS).

Guides for Erosion and Sediment Control in California, USDA Soils Conservation Service, January 1991.

Manual of Standards of Erosion and Sediment Control Measures, Association of Bay Area Governments, May 1995.

Proposed Guidance Specifying Management Measures for Sources of Nonpoint Pollution in Coastal Waters, Work Group Working Paper, USEPA, April 1992.

Sedimentation and Erosion Control, An Inventory of Current Practices Draft, U.S. EPA, April 1990.

Soil Erosion by Water Agricultural Information Bulletin #513, U.S. Department of Agriculture, Soil Conservation Service.

Stormwater Quality Handbooks Construction Site Best Management Practices (BMPs) Manual, State of California Department of Transportation (Caltrans), November 2000.

Water Quality Management Plan for the Lake Tahoe Region, Volume II, Handbook of Management Practices, Tahoe Regional Planning Agency, November 1988.

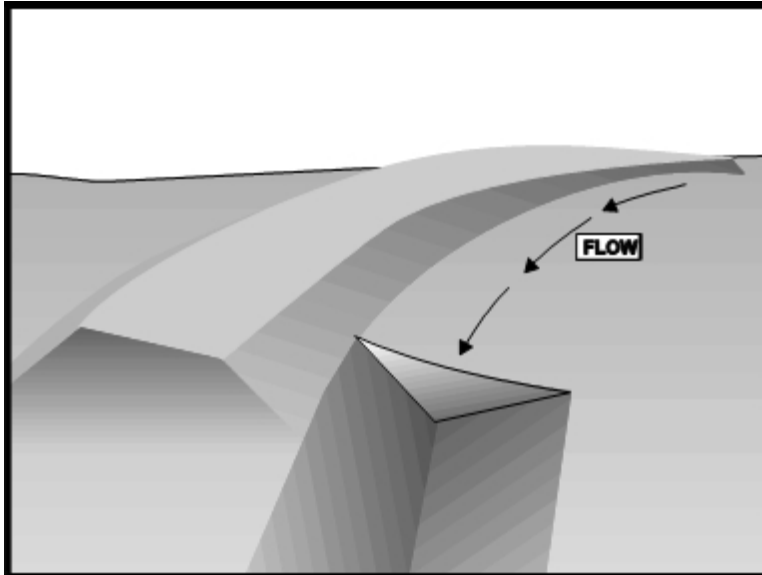

Description and Purpose

An earth dike is a temporary berm or ridge of compacted soil used to divert runoff or channel water to a desired location. A drainage swale is a shaped and sloped depression in the soil surface used to convey runoff to a desired location. Earth dikes and drainage swales are used to divert off site runoff around the construction site, divert runoff from stabilized areas and disturbed areas, and direct runoff into sediment basins or traps.

Suitable Applications

Earth dikes and drainage swales are suitable for use, individually or together, where runoff needs to be diverted from one area and conveyed to another.

- Earth dikes and drainage swales may be used:
 - To convey surface runoff down sloping land;
 - To intercept and divert runoff to avoid sheet flow over sloped surfaces;
 - To divert and direct runoff towards a stabilized watercourse, drainage pipe or channel;
 - To intercept runoff from paved surfaces;
 - Below steep grades where runoff begins to concentrate;
 - Along roadways and facility improvements subject to flood drainage;
 - At the top of slopes to divert runoff from adjacent or undisturbed slopes;

Objectives

- EC – Erosion Control ✓
- SE – Sediment Control
- TR – Tracking Control
- WE – Wind Erosion Control
- NS – Non-Storm Water Management Control
- WM – Waste Management & Materials Pollution Control

Legend:

- ✓ Primary Objective
- ▲ Secondary Objective

Targeted Constituents

- Sediment ✓
- Nutrients
- Trash
- Metals
- Bacteria
- Oil and Grease
- Organics

Potential Alternatives

None

- At bottom and mid slope locations to intercept sheet flow and convey concentrated flows; and
- Divert sediment laden runoff into sediment basins or traps.

Limitations

Dikes should not be used for drainage areas greater than 10 acres or along slopes greater than 10 percent. For larger areas more permanent drainage structures should be built. All drainage structures should be built in compliance with City municipal requirements.

- Earth dikes may create more disturbed area on site and become barriers to construction equipment.
- Earth dikes should be stabilized immediately, which adds cost and maintenance concerns.
- Diverted storm water may cause downstream flood damage.
- Dikes should not be constructed of soils that may be easily eroded.
- Regrading the site to remove the dike may add additional cost.
- Temporary drains and swales or any other diversion of runoff should not adversely impact upstream or downstream properties.
- Temporary drains and swales should conform to City floodplain management requirements.
- Earth dikes/drainage swales are not suitable as sediment trapping devices.
- It may be necessary to use other soil stabilization and sediment controls such as check dams, plastics, and blankets, to prevent scour and erosion in newly graded dikes, swales, and ditches.

Implementation

The temporary earth dike is a berm or ridge of compacted soil, located in such a manner as to divert storm water to a sediment trapping device or a stabilized outlet, thereby reducing the potential for erosion and offsite sedimentation. Earth dikes can also be used to divert runoff from off site and from undisturbed areas away from disturbed areas and to divert sheet flows away from unprotected slopes.

An earth dike does not itself control erosion or remove sediment from runoff. A dike prevents erosion by directing runoff to an erosion control device such as a sediment trap or directing runoff away from an erodible area. Temporary diversion dikes should not adversely impact adjacent properties and should conform to City floodplain management regulations, and should not be used in areas with slopes steeper than 10%.

Slopes that are formed during cut and fill operations should be protected from erosion by runoff. A combination of a temporary drainage swale and an earth dike at the top of a slope can divert runoff to a location where it can be brought to the bottom of the slope (see EC-11, Slope Drains). A combination dike and swale is easily constructed by a single pass of a bulldozer or grader and compacted by a second pass of the tracks or wheels over the ridge. Diversion structures should be installed when the site is initially graded and remain in place until post construction BMPs are installed and the slopes are stabilized.

Diversion practices concentrate surface runoff, increasing its velocity and erosive force. Thus, the flow out of the drain or swale should be directed onto a stabilized area or into a grade

stabilization structure. If significant erosion will occur, a swale should be stabilized using vegetation, chemical treatment, rock rip-rap, matting, or other physical means of stabilization. Any drain or swale that conveys sediment laden runoff should be diverted into a sediment basin or trap before it is discharged from the site.

General

- Care should be applied to correctly size and locate earth dikes, drainage swales. Excessively steep unlined dikes and swales are subject to erosion and gully formation.
- Conveyances should be stabilized.
- Use a lined ditch for high flow velocities.
- Select flow velocity based on careful evaluation of the risks due to erosion of the measure, soil types, overtopping, flow backups, washout, and drainage flow patterns for each project site.
- Compact any fills to prevent unequal settlement.
- Do not divert runoff onto other property without securing written authorization from the property owner.
- When possible, install and utilize permanent dikes, swales, and ditches early in the construction process.
- Provide stabilized outlets.

Earth Dikes

Temporary earth dikes are a practical, inexpensive BMP used to divert storm water runoff. Temporary diversion dikes should be installed in the following manner:

- All dikes should be compacted by earth moving equipment;
- All dikes should have positive drainage to an outlet;
- All dikes should have 2:1 or flatter side slopes, 18 in. minimum height, and a minimum top width of 24 in. Wide top widths and flat slopes are usually needed at crossings for construction traffic;
- The outlet from the earth dike should function with a minimum of erosion. Runoff should be conveyed to a sediment trapping device such as a Sediment Trap (SE-3) or Sediment Basin (SE-2) when either the dike channel or the drainage area above the dike are not adequately stabilized;
- Temporary stabilization may be achieved using seed and mulching for slopes less than 5% and either rip-rap or sod for slopes in excess of 5%. In either case, stabilization of the earth dike should be completed immediately after construction or prior to the first rain;
- If riprap is used to stabilize the channel formed along the toe of the dike, the following typical specifications apply:

Channel Grade	Riprap Stabilization
0.5-1.0%	4 in. Rock
1.1-2.0%	6 in. Rock
2.1-4.0%	8 in. Rock
4.1-5.0%	8 in. – 12 in. Rock

- The stone riprap, recycled concrete, etc. used for stabilization should be pressed into the soil with construction equipment;
- Filter cloth may be used to cover dikes in use for long periods; and
- Construction activity on the earth dike should be kept to a minimum.

Drainage Swales

Drainage swales are only effective if they are properly installed. Swales are more effective than dikes because they tend to be more stable. The combination of a swale with a dike on the downhill side is the most cost effective diversion.

Standard engineering design criteria for small open channel and closed conveyance systems should be used (see the City drainage design manual). Unless City drainage design criteria state otherwise, drainage swales should be designed as follows:

- No more than 5 acres may drain to a temporary drainage swale;
- Place drainage swales above or below, not on, a cut or fill slope;
- Swale bottom width should be at least 2 ft.;
- Depth of the swale should be at least 18 in.;
- Side slopes should be 2:1 or flatter;
- Drainage or swales should be laid at a grade of at least 1 percent, but not more than 15 percent;
- The on-site swale should not be overtopped by the peak discharge from a 10-year storm with 1-hour duration, irrespective of the design criteria stated above;
- Offsite diversion swale should not be overtopped by the offsite peak discharge from a 10-year storm with 1-hour duration, irrespective of the design criteria stated above. Remove all trees, stumps, obstructions, and other objectionable material from the swale when it is built;
- Compact any fill material along the path of the swale;
- Stabilize all swales immediately. Seed and mulch swales at a slope of less than 5 percent, and use rip-rap or sod for swales with a slope between 5 and 15 percent. For temporary swales, geotextiles and mats (EC-7) may provide immediate stabilization;
- Irrigation may be required to establish sufficient vegetation to prevent erosion;
- Do not operate construction vehicles across a swale unless a stabilized crossing is provided;
- Permanent drainage facilities should be designed by a professional engineer (see the City drainage design criteria for proper design);
- At a minimum, the drainage swale should conform to predevelopment drainage patterns and capacities;
- Construct the drainage swale with a positive grade to a stabilized outlet; and
- Provide erosion protection or energy dissipation measures if the flow out of the drainage swale can reach an erosive velocity. Consider using protective lining such as vegetation, geotextile filter fabric, rip rap, or concrete lining.

Costs

- Cost in California ranges from \$15 to \$55 per ft. for both earthwork and stabilization and depends on availability of material, site location, and access.
- Small dikes: \$2.50 - \$6.50/linear ft. Large dikes: \$2.50/yd³.
- The cost of a drainage swale increases with drainage area and slope. Typical swales for controlling internal erosion are inexpensive, as they are quickly formed during routine earthwork. Note that Hawaii's unit prices are higher than California's unit prices.

Inspection and Maintenance

- Inspect BMPs prior to forecast rain, daily during extended rain events, after rain events, weekly during the rainy season, and at two-week intervals during the non-rainy season.
- Inspect BMPs subject to non-storm water discharges daily while non-storm water discharges occur.
- Inspect ditches and berms for washouts. Replace lost riprap, damaged linings or soil stabilizers as needed.
- Inspect channel linings, embankments, and beds of ditches and berms for erosion and accumulation of debris and sediment. Remove debris and sediment and repair linings and embankments as needed.
- Temporary conveyances should be completely removed as soon as the surrounding drainage area has been stabilized or at the completion of construction.

References

California Stormwater Quality Association (CASQA) Best Management Practices Handbook Construction, 2003.

Manual of Standards of Erosion and Sediment Control Measures, Association of Bay Area Governments, May 1995.

National Association of Home Builders (NAHB). Stormwater Runoff & Nonpoint Source Pollution Control Guide for Builders and Developers. National Association of Home Builders, Washington, D.C., 1995.

National Management Measures to Control Nonpoint Source Pollution from Urban Areas, United States Environmental Protection Agency, 2002.

Rules Relating to Storm Drainage Standard, Department of Planning & Permitting, City & County of Honolulu, January 2000 (or revisions thereafter).

Southeastern Wisconsin Regional Planning Commission (SWRPC). Costs of Urban Nonpoint Source Water Pollution Control Measures. Technical Report No. 31. Southeastern Wisconsin Regional Planning Commission, Waukesha, WI, 1991.

Stormwater Management of the Puget Sound Basin, Technical Manual, Publication #91-75, Washington State Department of Ecology, February 1992.

Stormwater Quality Handbooks Construction Site Best Management Practices (BMPs) Manual, State of California Department of Transportation (Caltrans), November 2000.

Water Quality Management Plan for the Lake Tahoe Region, Volume II, Handbook of Management Practices, Tahoe Regional Planning Agency, November 1988.

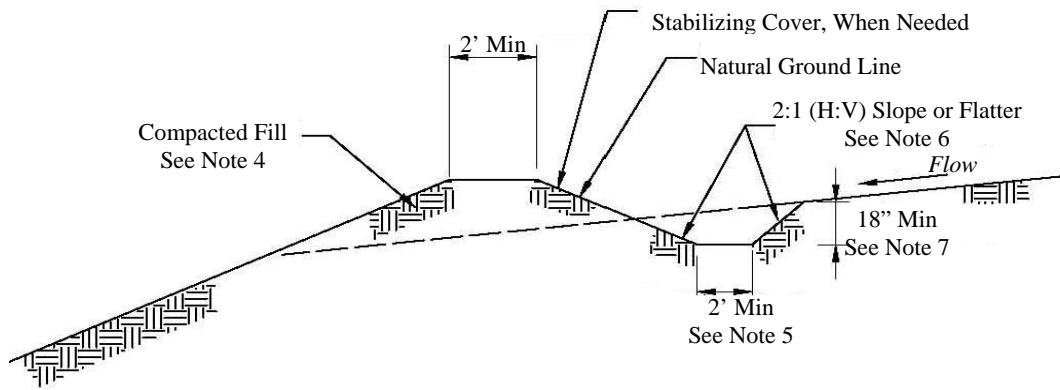

Drainage Swale Section "A"

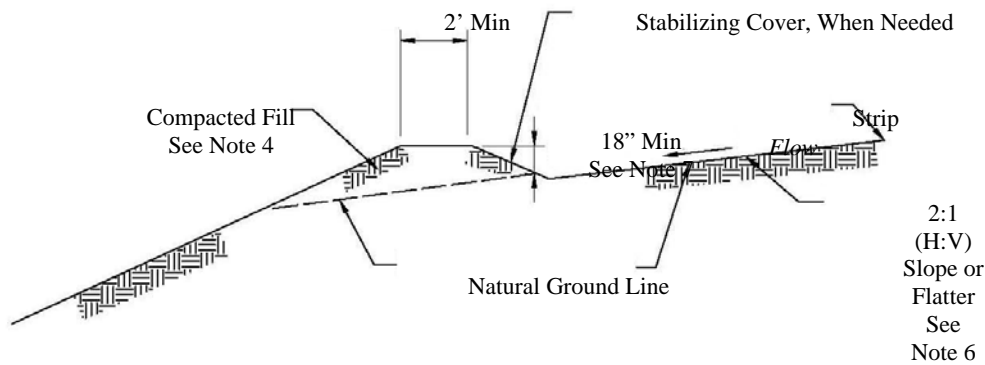

Earth Dike Section "B"

Notes:

1. Place drainage swales above or below, not on, a cut or fill slope.
2. Drainage or swales should be laid at a grade of at least 1 percent, but not more than 15 percent.
3. Remove all trees, stumps, obstructions, and other objectionable material from the swale.
4. Fill material along the path of the swale should be compacted to at least 90% compaction.
5. Swale top and bottom width should be at least 2 ft.
6. Side slopes should be 2:1 or flatter.
7. Depth of the swale should be at least 18 in.
8. Construct the drainage swale with a positive grade to a stabilized outlet.
9. Use a lined ditch for high flow velocities.
10. Temporary stabilization may be achieved using seed and mulching for slopes less than 5% and either rip-rap or sod for slopes in excess of 5%.
11. If rip-rap is used to stabilize the channel formed along the toe of the dike, the following typical specifications apply:

Channel Grade	Riprap Stabilization
0.5-1.0%	4 in. Rock
1.1-2.0%	6 in. Rock
2.1-4.0%	8 in. Rock
4.1-5.0%	8 in. – 12 in. Rock

Drainage Swale and Earth Dike

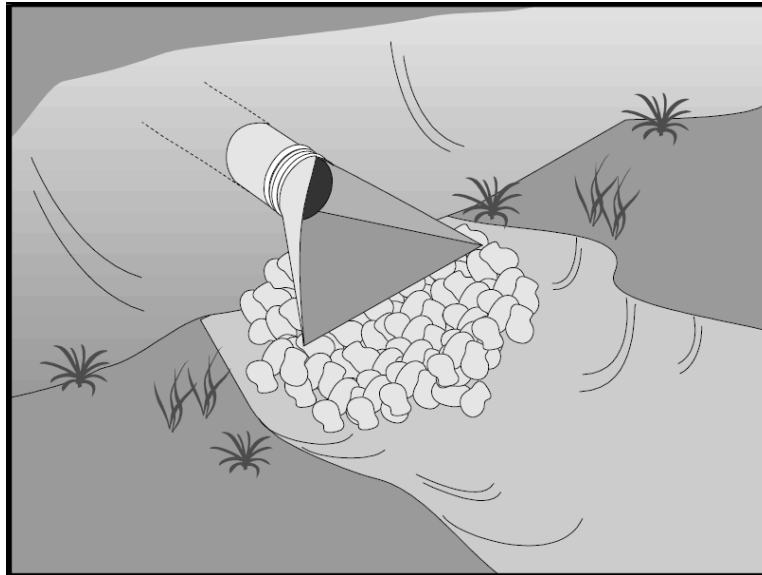

Description and Purpose

Outlet protection is a physical device composed of rock, grouted riprap, or concrete rubble, which is placed at the outlet of a pipe or channel to prevent scour of the soil caused by concentrated, high velocity flows.

Suitable Applications

Whenever discharge velocities and energies at the outlets of culverts, conduits, or channels are sufficient to erode the next downstream reach. This includes temporary diversion structures to divert runoff during construction.

- These devices may be used at the following locations:
 - Outlets of pipes, drains, culverts, slope drains, diversion ditches, swales, conduits, or channels;
 - Outlets located at the bottom of mild to steep slopes;
 - Discharge outlets that carry continuous flows of water;
 - Outlets subject to short, intense flows of water, such as flash floods; and
 - Points where lined conveyances discharge to unlined conveyances

Limitations

- Large storms or high flows can wash away the rock outlet protection and leave the area susceptible to erosion.
- Sediment captured by the rock outlet protection may be difficult to remove without removing the rock.

Objectives

EC – Erosion Control	√
SE – Sediment Control	
TR – Tracking Control	
WE – Wind Erosion Control	
NS – Non-Storm Water Management Control	
WM – Waste Management & Materials Pollution Control	

Legend:

- √ Primary Objective
- ▲ Secondary Objective

Targeted Constituents

Sediment	√
Nutrients	
Trash	
Metals	
Bacteria	
Oil and Grease	
Organics	

Potential Alternatives

None

- Outlet protection may negatively impact the channel habitat.
- If there is not adequate drainage, and water builds up behind grouted riprap, it may cause the grouted riprap to break up due to the resulting hydrostatic pressure.

Implementation

General

Outlet protection is needed where discharge velocities and energies at the outlets of culverts, conduits or channels are sufficient to erode the immediate downstream reach. This practice protects the outlet from developing small eroded pools (plunge pools), and protects against gully erosion resulting from scouring at a culvert mouth.

Design and Layout

As with most channel design projects, depth of flow, roughness, gradient, side slopes, discharge rate, and velocity should be considered in the outlet design. Compliance to city and state regulations should also be considered while working in environmentally sensitive streambeds. General recommendations for rock size and length of outlet protection mat are shown in the rock outlet protection figure in this BMP and should be considered minimum. The apron length and rock size gradation are determined using a combination of the discharge pipe diameter and estimate discharge rate: Select the longest apron length and largest rock size suggested by the pipe size and discharge rate. Where flows are conveyed in open channels such as ditches and swales, use the estimated discharge rate for selecting the apron length and rock size. Flows should be same as the culvert or channel design flow but never the less than the peak 10-year, 1-hour duration peak flow for temporary structures.

- There are many types of energy dissipaters, with rock being the one that is represented in the attached figure.
- Best results are obtained when sound, durable, and angular rock is used.
- Install riprap, grouted riprap, or concrete apron at selected outlet. Riprap aprons are best suited for temporary use during construction. Grouted or wired tied rock riprap can minimize maintenance requirements.
- Rock outlet protection is usually less expensive and easier to install than concrete aprons or energy dissipaters. It also serves to trap sediment and reduce flow velocities.
- Carefully place riprap to avoid damaging the filter fabric.
 - Stone 4 in. to 6 in. may be carefully dumped onto filter fabric from a height not to exceed 12 in.
 - Stone 8 in. to 12 in. should be hand placed onto filter fabric, or the filter fabric may be covered with 4 in. of gravel and the 8 in. to 12 in. rock may be dumped from a height not to exceed 16 in.
 - Stone greater than 12 in. should only be dumped onto filter fabric protected with a layer of gravel with a thickness equal to one half the D50 rock size, and the dump height limited to twice the depth of the gravel protection layer thickness.

- For proper operation of apron: Align apron with receiving stream and keep straight throughout its length. If a curve is needed to fit site conditions, place it in upper section of apron.
- Outlets on slopes steeper than 10 percent should have additional protection.

Costs

Costs are low if material is readily available. If material is imported, costs will be higher. Average installed cost is \$150 per device in California. Note that Hawaii's unit prices are higher than California's unit prices.

Inspection and Maintenance

- Inspect BMPs prior to forecast rain, daily during extended rain events, after rain events, weekly during the rainy season, and at two-week intervals during the non-rainy season.
- Inspect BMPs subjected to non-storm water discharges daily while non-storm water discharges occur.
- Inspect apron for displacement of the riprap and damage to the underlying fabric. Repair fabric and replace riprap that has washed away. If riprap continues to wash away, consider using larger material.
- Inspect for scour beneath the riprap and around the outlet. Repair damage to slopes or underlying filter fabric immediately.
- Temporary devices should be completely removed as soon as the surrounding drainage area has been stabilized or at the completion of construction.

References

California Stormwater Quality Association (CASQA) Best Management Practices Handbook Construction, 2003.

County of Sacramento Improvement Standards, Sacramento County, May 1989.

Erosion and Sediment Control Handbook, S.J. Goldman, K. Jackson, T.A. Bursztynsky, P.E., McGraw Hill Book Company, 1986.

Handbook of Steel Drainage & Highway Construction, American Iron and Steel Institute, 1983.

Manual of Standards of Erosion and Sediment Control Measures, Association of Bay Area Governments, May 1995.

Rules Relating to Storm Drainage Standard, Department of Planning & Permitting, City & County of Honolulu, January 2000 (or revisions thereafter).

Stormwater Management of the Puget Sound Basin, Technical Manual, Publication #91-75, Washington State Department of Ecology, February 1992. Stormwater Quality Handbooks Construction Site Best Management Practices (BMPs) Manual, State of California Department of Transportation (Caltrans), November 2000.

Water Quality Management Plan for the Lake Tahoe Region, Volume II, Handbook of Management Practices, Tahoe Regional Planning Agency, November 1988.

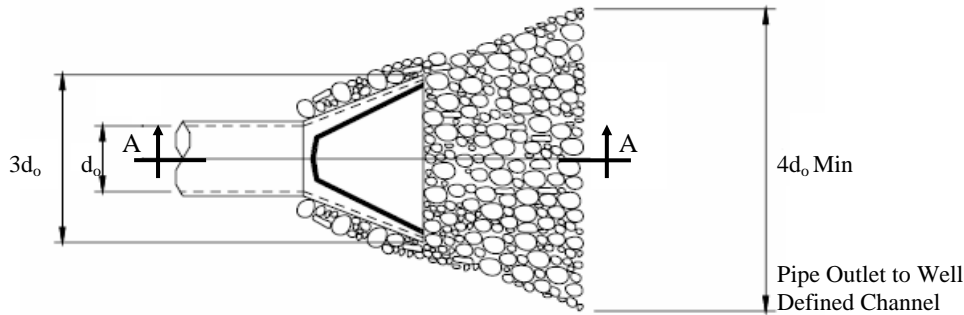

Plan "A"

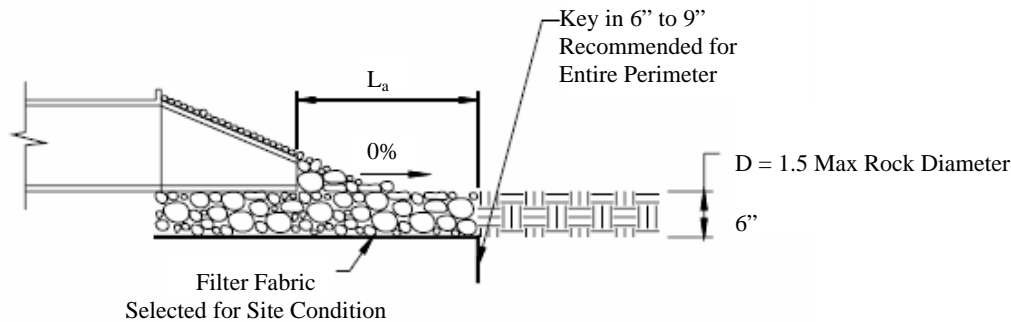

Section A-A

Notes:

1. The apron length and rock size gradation are determined using the table above.
2. Install riprap, grouted riprap, or concrete apron at selected outlet. Riprap aprons are best suited for temporary use during construction. Grouted or wired tied rock riprap can minimize maintenance requirements.
3. Carefully place riprap to avoid damaging the filter fabric.
 - a. Stone 4 in. to 6 in. may be carefully dumped onto filter fabric from a height not to exceed 12 in.
 - b. Stone 8 in. to 12 in. should be hand placed onto filter fabric, or the filter fabric may be covered with 4 in. of gravel and the 8 in. to 12 in. rock may be dumped from a height not to exceed 16 in.
 - c. Stone greater than 12 in. should only be dumped onto filter fabric protected with a layer of gravel with a thickness equal to one half the D50 rock size, and the dump height limited to twice the depth of the gravel protection layer thickness.
4. Outlets on slopes steeper than 10 percent should have additional protection.
5. Design should comply with city and state regulations.

Pipe Diameter, d_o (inches)	Discharge (ft ³ /s)	Apron Length, L_a (ft)	Rip Rap D50 Diameter Min (inches)
12	5	10	4
	10	13	6
18	10	10	6
	20	16	8
	30	23	12
	40	26	16
24	30	16	8
	40	26	8
	50	26	12
	60	30	16

For larger or higher flows consult a Licensed Civil Engineer

Source: USDA- SCS

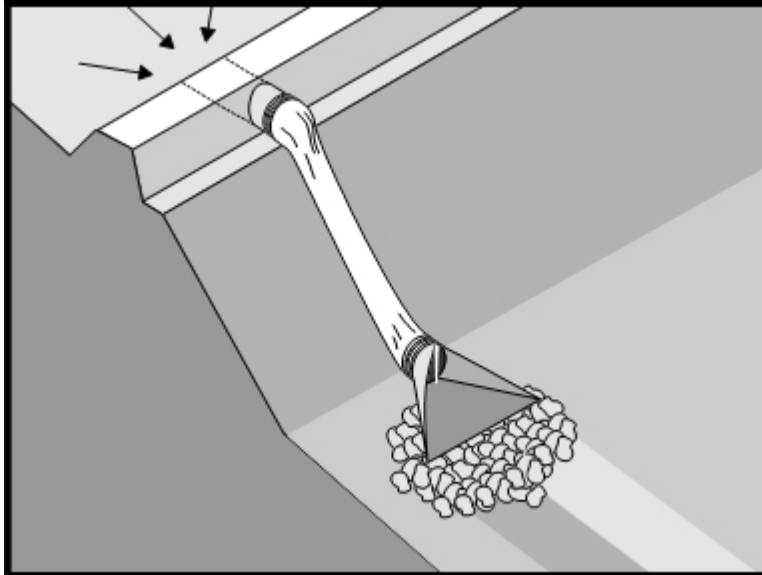

Description and Purpose

A slope drain is a pipe used to intercept and direct surface runoff or groundwater into a stabilized watercourse, trapping device, or stabilized area. Slope drains are used with earth dikes and drainage ditches to intercept and direct surface flow away from slope areas to protect cut or fill slopes.

Suitable Applications

- Where concentrated flow of surface runoff should be conveyed down a slope in order to prevent erosion.
- Drainage for top of slope diversion dikes or swales.
- Drainage for top of cut and fill slopes where water can accumulate.
- Emergency spillway for a sediment basin.

Limitations

Installation is critical for effective use of the pipe slope drain to minimize potential gully erosion.

- Recommendations given here are for temporary slope drains and not post construction. Check with other design guidance if post construction slope drains are to be installed.
- Maximum drainage area per slope drain is 10 acres. (For large areas use a paved chute, rock lined channel, or additional pipes).
- Severe erosion may result when slope drains fail by overtopping, piping, or pipe separation.

Objectives

- EC – Erosion Control ✓
- SE – Sediment Control
- TR – Tracking Control
- WE – Wind Erosion Control
- NS – Non-Storm Water Management Control
- WM – Waste Management & Materials Pollution Control

Legend:

- ✓ Primary Objective
- ▲ Secondary Objective

Targeted Constituents

- Sediment ✓
- Nutrients
- Trash
- Metals
- Bacteria
- Oil and Grease
- Organics

Potential Alternatives

- EC-9 Earth Dike, Drainage Swales

- During large storms, pipe slope drains may become clogged or over charged, forcing water around the pipe and causing extreme slope erosion.
- If the sectional down drain is not sized correctly, the runoff can spill over the drain sides causing gully erosion and potential failure of the structure.
- Dissipation of high flow velocities at the pipe outlet is required to avoid downstream erosion.

Implementation

General

The slope drain is applicable for any construction site where concentrated surface runoff can accumulate and should be conveyed down the slope in order to prevent erosion. The slope drain is effective because it prevents the storm water from flowing directly down the slope by confining all the runoff into an enclosed pipe or channel. Due to the time lag between grading slopes and installation of permanent storm water collection systems and slope stabilization measures, temporary provisions to intercept runoff are sometimes necessary. Particularly in steep terrain, slope drains can protect unstabilized areas from erosion.

Installation

The slope drain may be a rigid pipe, such as corrugated metal, a flexible conduit, or a lined terrace drain with the inlet placed on the top of a slope and the outlet at the bottom of the slope. This BMP typically is used in combination with a diversion control, such as an earth dike or drainage swale at the top of the slope.

The following criteria should be considered when siting slope drains.

- Permanent structures included in the project plans can often serve as construction BMPs if implemented early. However, the permanent structure should meet or exceed the criteria for the temporary structure;
- Inlet structures should be securely entrenched and compacted to avoid severe gully erosion;
- Slope drains should be securely anchored to the slope and should be adequately sized to carry the capacity of the design storm and associated forces;
- Outlets should be stabilized with riprap, concrete or other type of energy dissipater, or directed into a stable sediment trap or basin. See EC-01, Velocity Dissipation Devices;
- Debris racks are recommended at the inlet. Debris racks located several feet upstream of the inlet can usually be larger than racks at the inlet, and thus provide enhanced debris protection and less plugging;
- Safety racks are also recommended at the inlet and outlet of pipes where children or animals could become entrapped;
- Secure inlet and surround with dikes to prevent gully erosion and anchor pipe to slope;
- When using slope drains, limit drainage area to 10 acres per pipe. For larger areas, use a rock lined channel or a series of pipes;
- Maximum slope generally limited to 2:1 (H:V) as energy dissipation below steeper slopes is difficult;

- Direct surface runoff to slope drains with interceptor dikes. See BMP EC-00, Earth Dikes and Drainage Swales. Top of interceptor dikes should be 12 in. higher than the top of the slope drain;
- Slope drains can be placed on or buried underneath the slope surface;
- Recommended materials include both metal and plastic pipe, either corrugated or smooth wall. Concrete pipe can also be used; and
- When installing slope drains:
 - Install slope drains perpendicular to slope contours;
 - Compact soil around and under entrance, outlet, and along length of pipe;
 - Securely anchor and stabilize pipe and appurtenances into soil;
 - Check to ensure that pipe connections are watertight;
 - Protect area around inlet with filter cloth. Protect outlet with riprap or other energy dissipation device. For high energy discharges, reinforce riprap with concrete or use reinforced concrete device;
 - Protect outlet of slope drains using a flared end section when outlet discharges to a flexible energy dissipation device; and
 - A flared end section installed at the inlet will improve flow into the slope drain and prevent erosion at the pipe entrance. Use a flared end section with a 6 in. minimum toe plate to help prevent undercutting. The flared section should slope towards the pipe inlet.

Design and Layout

The capacity for temporary drains intercepting offsite or on-site runoff should be sufficient to convey at least the peak runoff from a 10-year, 1-hour duration rainfall event. The pipe size may be computed using the Rational Method or alternate methods accepted by the City and County of Honolulu. Higher flows should be safely stored or routed to prevent any offsite concentration of flow and any erosion of the slope. The design storm is purposely conservative due to the potential impacts associated with system failures.

As a guide, temporary pipe slope drains should not be sized smaller than shown in the following table:

Minimum Pipe Diameter (Inches)	Maximum Drainage Area (Acres)
12	1.0
18	3.0
21	5.0
24	7.0
30	10.0

Larger drainage areas can be treated if the area can be subdivided into areas of 10 acres or less and each area is treated as a separate drainage. Drainage areas exceeding 10 acres should be designed by a Licensed Civil Engineer and approved by the agency that issued the grading permit.

Materials

Soil type, rainfall patterns, construction schedule, site requirements, and available supply are some of the factors to be considered when selecting materials. The following types of slope drains are commonly used:

- **Rigid Pipe:** This type of slope drain is also known as a pipe drop. The pipe usually consists of corrugated metal pipe or rigid plastic pipe. The pipe is placed on undisturbed or compacted soil and secured onto the slope surface or buried in a trench. Concrete thrust blocks should be used when warranted by the calculated thrust forces. Collars should be properly installed and secured with metal strappings or watertight collars;
- **Flexible Pipe:** The flexible pipe slope drain consists of a flexible tube of heavy-duty plastic, rubber, or composite material. The tube material is securely anchored onto the slope surface. The tube should be securely fastened to the metal inlet and outlet conduit sections with metal strappings or watertight collars;
- **Section Downdrains:** The section downdrain consists of pre-fabricated, section conduit of half round or third round material. The sectional downdrain performs similar to a flume or chute. The pipe should be placed on undisturbed or compacted soil and secured into the slope; and
- **Concrete-lined Terrace Drain:** This is a concrete channel for draining water from a terrace on a slope to the next level. These drains are typically specified as permanent structures and, if installed early, can serve as slope drains during construction, which should be designed according to the City and County of Honolulu’s drainage design criteria.

Costs

Cost varies based on pipe selection and selected outlet protection in California. Note that Hawaii’s unit prices are higher than California’s unit prices.

Temporary Slope Drains

Corrugated Steel Pipes, Per Foot	
Size	Supplied and Installed Cost (No Trenching Included)
12”	\$19.60 per LF
15”	\$22.00
18”	\$26.00
24”	\$32.00
30”	\$50.00
PVC Pipes, Per Foot	
Size	Supplied and Installed Cost (No Trenching Included)
12”	\$24.50
14”	\$49.00
16”	\$51.00
18”	\$54.00
20”	\$66.00
24”	\$93.00
30”	\$130.00

Inspection and Maintenance

- Inspect BMPs prior to forecast rain, daily during extended rain events, after rain events, weekly during the rainy season, at two-week intervals during the non-rainy season, or as required by State or City and County representatives.
- Inspect BMPs subjected to non-storm water discharges daily while non-storm water discharges occur.
- Inspect outlet for erosion and downstream scour. If eroded, repair damage and install additional energy dissipation measures. If downstream scour is occurring, it may be necessary to reduce flows being discharged into the channel unless other preventative measures are implemented.
- Insert inlet for clogging or undercutting. Remove debris from inlet to maintain flows. Repair undercutting at inlet and if needed, install flared section or rip rap around the inlet to prevent further undercutting.
- Inspect pipes for leakage. Repair leaks and restore damaged slopes.
- Inspect slope drainage for accumulations of debris and sediment.
- Remove built up sediment from entrances and outlets as required. Flush drains if necessary; capture and settle out sediment from discharge.
- Make sure water is not ponding onto inappropriate areas (e.g., active traffic lanes, material storage areas, etc.).
- Pipe anchors should be checked to ensure that the pipe remains anchored to the slope. Install additional anchors if pipe movement is detected.

References

California Stormwater Quality Association (CASQA) Best Management Practices Handbook Construction, 2003.

Draft – Sedimentation and Erosion Control, An Inventory of Current Practices, U.S.E.P.A., April 1990.

National Association of Home Builders (NAHB). Stormwater Runoff & Nonpoint Source Pollution Control Guide for Builders and Developers. National Association of Home Builders, Washington, D.C., 1995.

National Management Measures to Control Nonpoint Source Pollution from Urban Areas, United States Environmental Protection Agency, 2002.

Rules Relating to Storm Drainage Standard, Department of Planning & Permitting, City & County of Honolulu, January 2000 (or revisions thereafter).

Stormwater Quality Handbooks Construction Site Best Management Practices (BMPs) Manual, State of California Department of Transportation (Caltrans), November 2000.

Stormwater Management of the Puget Sound Basin, Technical Manual, Publication #91-75, Washington State Department of Ecology, February 1992.

Water Quality Management Plan for the Lake Tahoe Region, Volume II, Handbook of Management Practices, Tahoe Regional Planning Agency, November 1988.

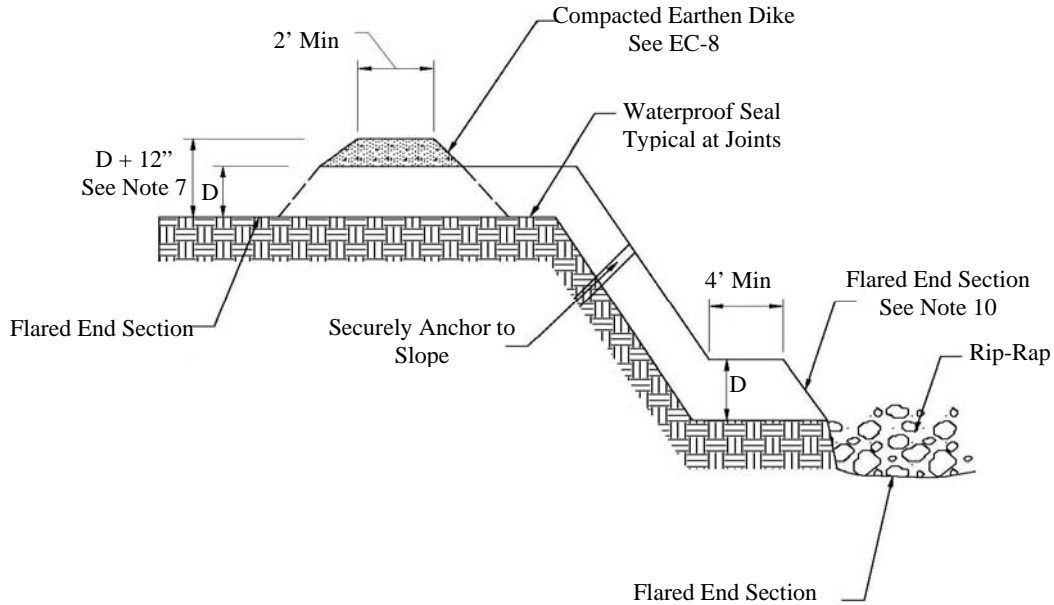

Section “A”

Notes:

1. Install slope drains perpendicular to slope contours.
2. Slope drains can be placed on or buried underneath the slope surface.
3. Compact soil around and under entrance, outlet, and along length of pipe.
4. Securely anchor and stabilize pipe and appurtenances into soil.
5. Check to ensure that pipe connections are watertight.
6. Protect area around inlet with filter cloth.
7. Top of interceptor dikes should be 12 in. higher than the top of the slope drain.
8. Maximum slope generally limited to 2:1 (H:V).
9. Direct surface runoff to slope drains with interceptor dikes. See BMP EC-00, Earth Dikes and Drainage Swales.
10. Protect outlet of slope drains using a flared end section when outlet discharges to a flexible energy dissipation device. The flared section should slope towards the pipe inlet.
11. The pipe size may be computed using the Rational Method or alternate methods accepted by the City and County of Honolulu.

As a guide, temporary pipe slope drains should not be sized smaller than shown in the following table:

Minimum Pipe Diameter, D (Inches)	Maximum Drainage Area (Acres)
12	1.0
18	3.0
21	5.0
24	7.0
30	10.0

12. Recommended materials include both metal and plastic pipe, either corrugated or smooth wall. Concrete pipe can also be used.

Typical Slope Drain



Description and Purpose

Stream channels, streambanks, and associated riparian areas are dynamic and sensitive ecosystems that respond to changes in land use activity. Streambank and channel disturbance resulting from construction activities can increase the stream’s sediment load, which can cause channel erosion or sedimentation and have adverse affects on the biotic system. BMPs can reduce the discharge of sediment and other pollutants to minimize the impact of construction activities on watercourses. Streams on the 303(d) list and listed for sediment may require numerous measures to prevent any increases in sediment load to the stream.

Suitable Applications

These procedures typically apply to all construction projects that disturb or occur within stream channels and their associated riparian areas.

Limitations

Specific permit requirements or mitigation measures such as U.S. Army Corps of Engineers 404 permit, City and County of Honolulu Department of Planning and Permitting (DPP), State of Hawaii Department of Land and Natural Resources (DLNR) Commission on Water Resource Management (CWRM) Stream Channel Alteration Permit (SCAP), and approval by Department of Health (DOH) Clean Water Branch (CWB) supersede the guidance in this BMP.

Objectives

- EC – Erosion Control ✓
- SE – Sediment Control ▲
- TR – Tracking Control
- WE – Wind Erosion Control
- NS – Non-Storm Water Management Control ▲
- WM – Waste Management & Materials Pollution Control

Legend:

- ✓ Primary Objective
- ▲ Secondary Objective

Targeted Constituents

- Sediment ✓
- Nutrients
- Trash
- Metals
- Bacteria
- Oil and Grease
- Organics

Potential Alternatives

Combination of erosion and sediment controls.

- If numerical based water quality standards are mentioned in any of these and other related permits, testing and sampling may be required. Streams listed as 303(d) impaired for sediment, silt, or turbidity, are required to conduct sampling to verify that there is no net increase in sediment load due to construction activities.

Implementation

- For instream work, a Clean Water Act Section 401 Water Quality Certification Permit is required by the State Department of Health (HAR 11-54 Water Quality Standards), and Section 404 permit (33 United States Doc 1344) is required by the US Army Corps of Engineers.
- For state stream alteration, as opposed to maintenance/repair of a state stream, the Department of Land and Natural Resources Stream Channel Alteration Permit is required (HAR 13-168 Water Use, Wells, and Stream Diversion Works; and HAR 13-169 Protection of Instream Uses of Water).
- The City's Grading Permit is required for grubbing over 15,000 square feet, cut 50 cubic yards, or fill over 50 cubic yards (ROH 14-13.5 Exclusions).

Planning

- Proper planning, design, and construction techniques can minimize impacts normally associated within stream construction activities. Poor planning can adversely affect soil, fish, wildlife resources, land uses, or land users. Planning should take into account: scheduling; avoidance of in-stream construction; minimizing disturbance area and construction time period; using pre-disturbed areas; selecting crossing location; and selecting equipment.

Scheduling

- Construction activities should be scheduled according to the relative sensitivity of the environmental concerns and in accordance with EC-1, Scheduling. Scheduling considerations will be different when working near perennial streams vs. ephemeral streams and are as follows.
- When working in or near ephemeral streams, work should be performed during the dry season. By their very nature, ephemeral streams are usually dry in the summer, and therefore, in-stream construction activities will not cause significant water quality problems. However, when tying up the site at the end of the project, wash any fines (see Washing Fines) that accumulated in the channel back into the bed material, to decrease pollution from the first rainstorm of the season.
- When working near ephemeral or perennial streams, erosion and sediment controls (see silt fences, straw bale barriers, etc.) should be implemented to keep sediment out of stream channel.

Minimize Disturbance

- Minimize disturbance through: selection of the narrowest crossing location; limiting the number of equipment trips across a stream during construction; and, minimizing the number and size of work areas (equipment staging areas and spoil storage areas). Place work areas away from stream channel. Field reconnaissance should be conducted during the planning stage to identify work areas.

Use of Pre-Disturbed Areas

- Locate project sites and work areas in areas disturbed by prior construction or other activity when possible.

Selection of Project Site

- Avoid steep and unstable banks, highly erodible or saturated soils, or highly fractured rock.
- Select project site that minimizes disturbance to aquatic species or habitat.

Equipment Selection

- Select equipment that reduces the amount of pressure exerted on the ground surface, and therefore, reduces erosion potential and/or use overhead or aerial access for transporting equipment across drainage channels. Use equipment that exerts ground pressures of less than 5 or 6 lb/in², where possible. Low ground pressure equipment includes: wide or high flotation tires (34 to 72 in. wide); dual tires; bogie axle systems; tracked machines; lightweight equipment; and, central tire inflation systems.

Streambank Stabilization

Preservation of Existing Vegetation

- Preserve existing vegetation in accordance with EC-2, Preservation of Existing Vegetation. In a streambank environment, preservation of existing vegetation provides the following benefits.

Water Quality Protection

- Vegetated buffers on slopes trap sediment and promote groundwater recharge. The buffer width needed to maintain water quality ranges from 15 to 100 ft. On gradual slopes, most of the filtering occurs within the first 30 ft. Steeper slopes require a greater width of vegetative buffer to provide water quality benefits.

Streambank Stabilization

- The root system of riparian vegetation stabilizes streambanks by increasing tensile strength in the soil. The presence of vegetation modifies the moisture condition of slopes (infiltration, evapo-transpiration, interception) and increases bank stability.

Riparian Habitat

- Buffers of diverse riparian vegetation provide food and shelter for riparian and aquatic organisms. Minimizing impacts to fisheries habitat is a major concern when working near streams. Riparian vegetation provides shade, shelter, organic matter (leaf detritus and large woody debris), and other nutrients that are necessary for fish and other aquatic organisms. Buffer widths for habitat concerns are typically wider than those recommended for water quality concerns (100 to 1500 ft.).
- When working near watercourses, it is important to understand the work site's placement in the watershed. Riparian vegetation in headwater streams has a greater impact on overall water quality than vegetation in downstream reaches. Preserving existing vegetation upstream is necessary to maintain water quality, minimize bank failure, and maximize riparian habitat, downstream of the work site.

Limitations

- City ordinances regarding width, extent and type of vegetative buffer required may exceed the specifications provided here; these ordinances should be investigated prior to construction.

Streambank Stabilization Specific Installation

- As a general rule, the width of a buffer strip between a road and the stream is recommended to be 50 ft. plus four times the percent slope of the land, measured between the road and the top of stream bank.

Hydraulic Mulch

- Apply hydraulic mulch on disturbed streambanks above mean high water level in accordance with EC-3, Hydraulic Mulch to provide temporary soil stabilization.

Limitations

- Do not place hydraulic mulch or tackifiers below the mean high water level, as these materials could wash into the channel and impact water quality or possibly cause eutrophication (eutrophication is an algal bloom caused by excessively high nutrient levels in the water).

Hydroseeding

- Hydroseed disturbed streambanks in accordance with EC-4, Hydroseeding.

Limitations

- Do not place tackifiers or fertilizers below the mean high water level, as these materials could wash into the channel and impact water quality or possibly cause eutrophication.

Soil Binders

- Apply soil binders to disturbed streambanks in accordance with EC-5, Soil Binders.

Limitations

- Do not place soil binders below the mean high water level. Soil binder should be environmentally benign and non-toxic to aquatic organisms.

Geotextiles and Mats

- Install geotextiles and mats as described in EC-7, Geotextiles and Mats, to stabilize disturbed channels and streambanks. Not all applications should be in the channel, for example, certain geotextile netting may snag fish gills and are not appropriate in fish bearing streams. Geotextile fabrics that are not biodegradable are not appropriate for in stream use. Additionally, geotextile fabric or blankets placed in channels should be adequate to sustain anticipated hydraulic forces.

Earth Dikes, Drainage Swales, and Lined Ditches

- Convey, intercept, or divert runoff from disturbed streambanks using EC-9, Earth Dikes and Drainage Swales.

Limitations

- Do not place earth dikes in watercourses, as these structures are only suited for intercepting sheet flow, and should not be used to intercept concentrated flow.
- Appropriately sized velocity dissipation devices (EC-10) should be placed at outlets to minimize erosion and scour.

Velocity Dissipation Devices

- Place velocity dissipation devices at outlets of pipes, drains, culverts, slope drains, diversion ditches, swales, conduits or channels in accordance with EC-10, Velocity Dissipation Devices.

Slope Drains

- Use slope drains to intercept and direct surface runoff or groundwater into a stabilized watercourse, trapping device or stabilized area in accordance with EC-11, Slope Drains.

Limitations

- Appropriately sized outlet protection and velocity dissipation devices (EC-10) should be placed at outlets to minimize erosion and scour.

Streambank Sediment Control

Silt Fences

- Install silt fences in accordance with SE-1, Silt Fence, to control sediment. Silt fences should only be installed where sediment laden water can pond, thus allowing the sediment to settle out.

Fiber Rolls

- Install fiber rolls in accordance with SE-5, Fiber Rolls, along contour of slopes above the high water level to intercept runoff, reduce flow velocity, release the runoff as sheet flow and provide removal of sediment from the runoff. In a stream environment, fiber rolls should be used in conjunction with other sediment control methods such as SE-1 Silt Fence. Install silt fence, or other erosion control method along toe of slope above the high water level.

Gravel Bag Berm

- A gravel bag berm or barrier can be utilized to intercept and slow the flow of sediment laden sheet flow runoff in accordance with SE-6, Gravel Bag Berm. In a stream environment gravel bag barriers can allow sediment to settle from runoff before water leaves the construction site and can be used to isolate the work area from the live stream.

Limitations

- Gravel bag barriers are not recommended as a perimeter sediment control practice around streams.

Rock Filter

Description and Purpose

- Rock filters are temporary erosion control barriers composed of rock that is anchored in place. Rock filters detain the sediment laden runoff, retain the sediment, and release the water as sheet flow at a reduced velocity. Typical rock filter installations are illustrated at the end of this BMP.

Applications

- Near the toe of slopes that may be subject to flow and rill erosion.

Limitations

- Inappropriate for contributing drainage areas greater than 5 acres.
- Requires sufficient space for ponded water.
- Ineffective for diverting runoff because filters allow water to slowly seep through.
- Rock filter berms are difficult to remove when construction is complete.
- Unsuitable in developed areas or locations where aesthetics is a concern.

Specifications

- Rock: open graded rock, 0.75 to 5 in. for concentrated flow applications.
- Woven wire sheathing: 1 in. diameter, hexagonal mesh, galvanized 20 gauge (used with rock filters in areas of concentrated flow).
- In construction traffic areas, maximum rock berm heights should be 12 in. Berms should be constructed every 300 ft. on slopes less than 5%, every 200 ft. on slopes between 5% and 10%, and every 100 ft. on slopes greater than 10%.

Maintenance

- Inspect and verify that activity-based BMPs are in place prior to the commencement of associated activities. While activities associated with the BMP are under way, inspect weekly during the rainy season and at two-week intervals in the non-rainy season to verify continued BMP implementation.
- Inspect BMPs subject to non-storm water discharges daily while non-storm water discharges occur.
- Reshape berms as needed and replace lost or dislodged rock, and filter fabric.
- Sediment that accumulates in the BMP should be periodically removed in order to maintain BMP effectiveness. Sediment should be removed when the sediment accumulation reaches one third of the barrier height. Sediment removed during maintenance may be incorporated into earthwork on the site or disposed at an appropriate location.

K-rail

Description and Purpose

This is temporary sediment control that uses K-rails to form the sediment deposition area, or to isolate the near bank construction area. Install K-rails at toe of slope in accordance with procedures described in NS-5, Clear Water Diversion.

Barriers are placed end to end in a pre-designed configuration and gravel filled bags are used at the toe of the barrier and at their abutting ends to seal and prevent movement of sediment beneath or through the barrier walls.

Appropriate Applications

- This technique is useful at the toe of embankments, cuts or fills slopes.

Limitations

- The K-rail method should not be used to dewater a project site, as the barrier is not watertight.

Implementation

- Refer to NS-5, Clear Water Diversion, for implementation requirements.

Instream Construction Sediment Control

There are three different options currently available for reducing turbidity while working in a stream or river. The stream can be isolated from the area in which work is occurring by means of a water barrier, the stream can be diverted around the work site through a pipe or temporary channel, or one can employ construction practices that minimize sediment suspension.

Whatever technique is implemented, an important thing to remember is that dilution can sometimes be the solution. A probable “worst time” to release high total suspended solids (TSS) into a stream system might be when the stream is very low; summer low flow, for example. During these times, the flow may be low while the biological activity in the stream is very high. Conversely, the addition of high TSS or sediment during a big storm discharge might have a relatively low impact, because the stream is already turbid, and the stream energy is capable of transporting both suspended solids, and large quantities of bedload through the system. The optimum time to “pull” in-stream structures may be during the rising limb of a storm hydrograph.

Techniques to minimize Total Suspended Solids (TSS)

- **Padding** - Padding laid in the stream below the work site may trap some solids that are deposited in the stream during construction. After work is done, the padding is removed from the stream, and placed on the bank to assist in re-vegetation.
- **Clean, washed gravel** - Using clean, washed gravel decreases solid suspension, as there are fewer small particles deposited in the stream.
- **Excavation using a large bucket** - Each time a bucket of soil is placed in the stream, a portion is suspended. Approximately the same amount is suspended whether a small amount of soil is placed in the stream, or a large amount. Therefore, using a large excavator bucket instead of a small one, will reduce the total amount of soil that washes downstream.
- **Use of dozer for backfilling** - Using a dozer for backfilling instead of a backhoe follows the same principles – the fewer times soil is deposited in the stream, the less soil will be suspended.
- **Partial dewatering with a pump** - Partially dewatering a stream with a pump reduces the amount of water, and thus the amount of water that can suspend sediment.

Washing Fines

Definition and Purpose

- Washing fines is an “in-channel” sediment control method, which uses water, either from a water truck or hydrant, to wash stream fines that were brought to the surface of the channel bed during restoration, back into the interstitial spaces of the gravel and cobbles.
- The purpose of this technique is to reduce or eliminate the discharge of sediment from the channel bottom during the first seasonal flow. Sediment should not be allowed into stream channels; however, occasionally in-channel restoration work will involve moving or otherwise disturbing fines (sand and silt sized particles) that are already in the stream, usually below bankfull discharge elevation. Subsequent re-watering of the channel can result in a plume of turbidity and sedimentation.
- This technique washes the fines back into the channel bed. Bedload materials, including gravel cobbles, boulders and those fines, are naturally mobilized during higher storm flows. This technique is intended to delay the discharge until the fines would naturally be mobilized.

Appropriate Applications

- This technique should be used when construction work is required in channels. It is especially useful in intermittent or ephemeral streams in which work is performed “in the dry,” and which subsequently become re-watered.

Limitations

- The stream should have sufficient gravel and cobble substrate composition.
- The use of this technique requires consideration of time of year and timing of expected stream flows.
- The optimum time for the use of this technique is in the fall, prior to winter flows.
- Consultation with, and approval from the City, Department of Planning & Permitting (DPP), and Department of Health Clean Water Branch (CWB) may be required.

Implementation

- Apply sufficient water to wash fines, but not cause further erosion or runoff.
- Apply water slowly and evenly to prevent runoff and erosion.
- Consult with Department of Planning & Permitting (DPP) and Department of Health Clean Water Branch (CWB) for specific water quality requirements of applied water (e.g. chlorine).

Inspection and Maintenance

- None necessary.

Costs

Cost may vary according to the combination of practices implemented.

Inspection and Maintenance

- Inspect and verify that activity-based BMPs are in place prior to the commencement of associated activities. While activities associated with the BMP are under way, inspect weekly during the rainy season and at two-week intervals in the non-rainy season to verify continued BMP implementation.
- Inspect BMPs subject to non-storm water discharges daily while non-storm water discharges occur.
- Inspect and repair equipment (for damaged hoses, fittings, and gaskets).

References

California Stormwater Quality Association (CASQA) Best Management Practices Handbook Construction, 2003.

City & County of Honolulu, Department of Planning & Permitting Subdivision Rules and Regulations.

City & County of Honolulu, Revised Ordinances of Honolulu Section 14-14.2 Application for a Grading Permit.

Manual of Standards of Erosion and Sediment Control Measures, Association of Bay Area Governments, May 1995.

Proposed Guidance Specifying Management Measures for Sources of Nonpoint Pollution in Coastal Waters, Work Group Working Paper, USEPA, April 1992.

Sedimentation and Erosion Control Practices, An Inventory of Current Practices (Draft), UESPA, 1990.

Stormwater Management for Construction Activities, Developing Pollution Prevention Plans and Best Management Practices, EPA 832-R-92005; USEPA, April 1992.

Stormwater Quality Handbooks Construction Site Best Management Practices (BMPs) Manual, State of California Department of Transportation (Caltrans), November 2000.

Water Quality Management Plan for the Lake Tahoe Region, Volume II, Handbook of Management Practices, Tahoe Regional Planning Agency, November 1988.

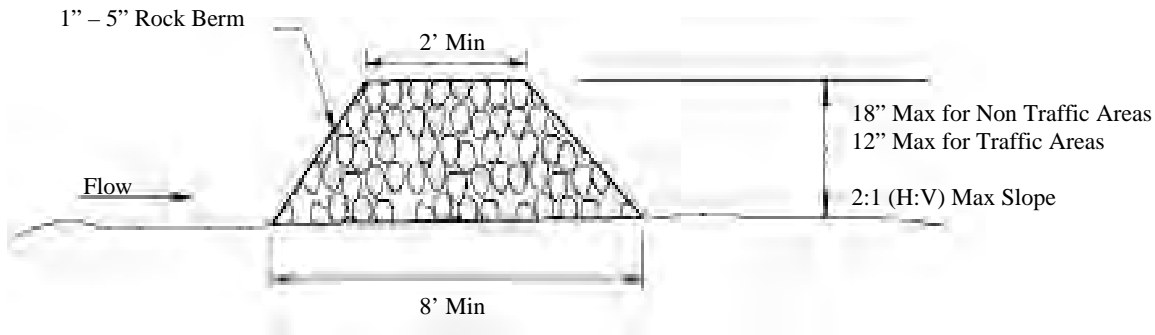

Section "A"

Not to Scale

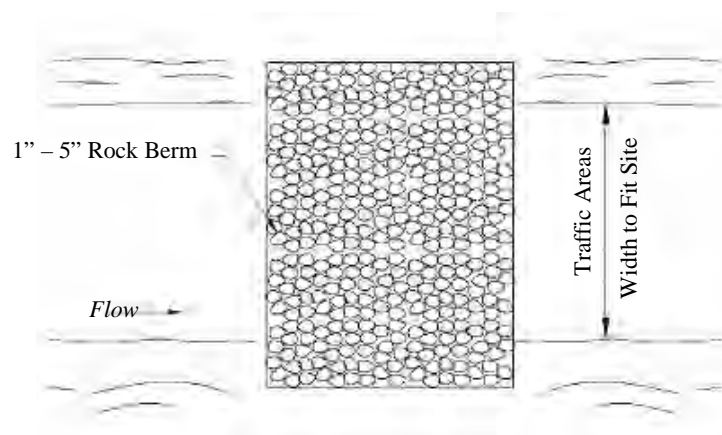

Plan View

Not to Scale

Notes:

1. Slope hazard analysis is required for cut and fill slopes greater than 15 feet in height and a grade steeper than 40% or 2.5:1 (H:V).
2. Maximum slope cannot exceed 40% and any filling of lot cannot exceed 5 feet in depth.
3. Place work areas at least 50 ft. from stream channel.
4. The width of a buffer strip between a road and the stream is recommended to be 50 ft. plus four times the percent slope of the land.
5. In construction traffic areas, maximum rock berm heights should be 12 in.
6. Berms should be constructed every 300 ft. on slopes less than 5%, every 200 ft. on slopes between 5% and 10%, and every 100 ft. on slopes greater than 10%.
7. Use open graded rock, with 0.75 to 5 in. diameter for concentrated flow applications.
8. Woven wire sheathing: 1 in. diameter, hexagonal mesh, galvanized 20 gauge (used with rock filters in areas of concentrated flow).
9. Select equipment that reduces the amount of pressure exerted on the ground surface, and therefore, reduces erosion potential and/or use overhead or aerial access for transporting equipment across drainage channels. Use equipment that exerts ground pressures of less than 5 or 6 lb/in², where possible. Low ground pressure equipment includes: wide or high flotation tires (34 to 72 in. wide); dual tires; bogie axle systems; tracked machines; lightweight equipment; and, central tire inflation systems.

Typical Rock Filter



Description and Purpose

Seeding and planting of trees, vines, shrubs and ground cover, and sodding can temporarily or permanently stabilize soil in an area by covering the surface with vegetation and allowing storm water to infiltrate. Sodding is also the most immediately effective vegetation method available.

Suitable Applications

Soil stabilization during or after the construction phase applies to the following site conditions:

- Graded/cleared areas without on-going construction activity,
- Open space and fill areas,
- Steep slopes,
- Spoil piles or temporary stockpile of fill material,
- Vegetated swales,
- Landscape corridors, and
- Streambanks.

Installation Requirements

When seeding, planting or sodding consider the following:

- Type of vegetation,
- Site and seedbed preparation,
- Seasonal planting time,
- Fertilization, and
- Water.

Objectives

- EC – Erosion Control ✓
- SE – Sediment Control
- TR – Tracking Control
- WE – Wind Erosion Control
- NS – Non-Storm Water Management Control
- WM – Waste Management & Materials Pollution Control

Legend:

- ✓ Primary Objective
- ▲ Secondary Objective

Targeted Constituents

- Sediment ✓
- Nutrients
- Trash
- Metals
- Bacteria
- Oil and Grease
- Organics

Potential Alternatives

Combination of erosion and sediment controls.

Grasses

- Ground preparation requires fertilization and mechanical stabilization of the soil.
- Short-term temperature extremes and waterlogged soil conditions tolerable.
- Appropriate soil conditions include a shallow soil base, good drainage, and 2:1 or flatter slope.
- Quickly develops from seeds.
- Vigorous grass growth dependent on mowing, irrigating, and fertilizing.
- Trees and Shrubs.
- Selection dependent on vigor, species, size, shape, and potential wildlife food source.
- Consider wind/exposure and irrigation requirements.
- Use indigenous species where possible.

Vines and Ground Cover

- Lime and fertilizer required for ground preparation.
- Use appropriate seeding rates.
- Consider requirements for drainage, acidity, and ground slope.
- Use indigenous species where possible.
- Avoid species which require irrigation.

Limitations

- During dry periods without irrigation, permanent and temporary vegetation may not be appropriate.
- Improper application of fertilizer may contribute to storm water pollution.
- The cost of sod stabilization (relative to other vegetative controls) typically limits its use to situations where a quick vegetative cover is desired (e.g., steep or erodible slopes) and sites which can be maintained with ground equipment.
- Sod is sensitive to climate and may require intensive watering and fertilization.

Inspection and Maintenance

Monitor vegetation growth and water, fertilize, mow, and/or prune the grasses/plants as needed.

Costs

All of the above are low cost measures.

References

Caltrans Construction Site Best Management Practices Manual, 2003.

State of Hawaii DOT Highway Division, Construction BMP Field Manual, February 2007.

U.S. Environmental Protection Agency, NPDES General Permit for Stormwater Discharge Requirements for Small and Large Construction Activities, 2008.

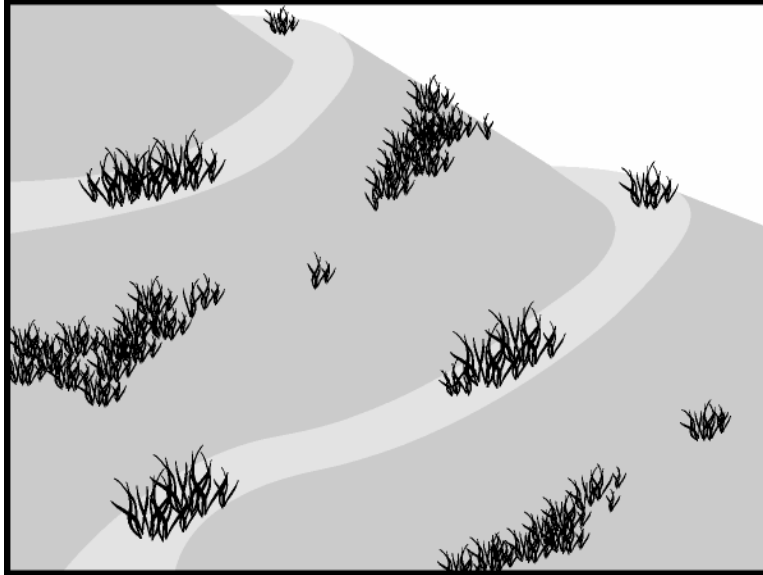

Description and Purpose

Slope roughening/terracing creates microclimates for establishing vegetation, reduces runoff velocity, increases infiltration, and provides small depression for trapping sediment.

Surface roughening is recommended for all slopes steeper than 3:1, and greater than 5 vertical feet, providing some in-state erosion protection on bare soil while vegetative cover is being established. It is an inexpensive, simple and short-term erosion control measure for roadway cut slopes.

Terracing usually is a more permanent measure used to stabilize a steep slope. Terraces should be designed by a licensed professional engineer and included in the project construction plans. City design criteria should be used.

Suitable Applications

- Any cleared area prior to seeding and planting.
- Recommended for cleared, erodible slopes steeper than 3:1 and higher than 5 feet prior to seeding and planting.

Implementation

- Slope roughening/terracing is performed in several ways:
 - Stair-step grading,
 - Grooving,
 - Furrowing,
 - Tracking,
 - Rough grading, and
 - No grading.

Objectives

EC – Erosion Control	√
SE – Sediment Control	▲
TR – Tracking Control	
WE – Wind Erosion Control	
NS – Non-Storm Water Management Control	
WM – Waste Management & Materials Pollution Control	

Legend:

- √ Primary Objective
- ▲ Secondary Objective

Targeted Constituents

Sediment	√
Nutrients	
Trash	
Metals	
Bacteria	
Oil and Grease	
Organics	

Potential Alternatives

None

- Slope hazard analysis is required for cut and fill slopes greater than 15 feet in height and a grade steeper than 40% or 2.5:1 (H:V).
- City subdivision rules and regulations for lot grading specify that maximum slope cannot exceed 40% and any filling of lot cannot exceed 5 feet in depth.

Requirements

- Maintenance:
 - Inspect roughened slopes weekly and after rainfall for excessive erosion; and
 - Revegetate as quickly as possible.
- Cost (Source: EPA, 1992):
 - Surface Roughening: Performed at no (e.g., rough grading) to low (e.g., tracking) cost; and
 - Terracing: Average annual cost is \$4 per linear foot (2 year useful life).

Limitations

- Roughening is of limited effectiveness on its own, but is used to speed revegetation.

Installation

Graded areas with smooth, hard surfaces give a false impression of “finished grading” and a job well done. It is difficult to establish vegetation on such surfaces due to reduced water infiltration and the potential for erosion. Rough slope surfaces with uneven soil and rocks left in place may appear unattractive or unfinished at first, but they encourage water infiltration, speed the establishment of vegetation, and decreased runoff velocity. Rough, loose soil surfaces give lime, fertilizer, and seed some natural coverage. Niches in the surface provide microclimates which generally provide a cooler and more favorable moisture level than hard flat surfaces; this aids seed germination.

There are different methods for achieving a roughened soil surface on a slope, and the selection of an appropriate method depends upon the type of slope. Roughening methods include stair-step grading, grooving, and tracking. Factors to be considered in choosing a method are slope steepness, mowing requirements, and whether the slope is formed by cutting or filling.

- Disturbed areas which will not require mowing may be stair-step graded, grooved, or left rough after filling.
- Graded areas steeper than 3:1 should be stair-stepped with benches (See Figure 1). The stair stepping will help vegetation become attached and also trap soil eroded from the slopes above. Stair-step grading is particularly appropriate in soils containing large amounts of soft rock. Each “step” catches material which sloughs from above, and provides a level site where vegetation can become established. Stairs should be wide enough to work with standard earth moving equipment.
- Graded areas with slopes greater than 3:1 but less than 2:1 should be roughened before seeding.

- It is important to avoid excessive compacting of the soil surface when scarifying. Tracking with bulldozer treads is preferable to not roughening at all, but is not as effective as other forms of roughening, as the soil surface is severely compacted and runoff is increased. Tracking can be accomplished in a variety of ways, including “track walking,” or driving a crawler tractor up and down the slope, in leaving a pattern of cleat imprints parallel to slope contours.

Costs

All of the above are low cost measures.

References

Best Management Practices and Erosion Control Manual for Construction Sites, Flood Control District of Maricopa County, Arizona, September 1992.

Caltrans Construction Site BMP Manual, 2003.

City & County of Honolulu, Department of Environmental Services, Construction BMP Manual, March, 1999.

City & County of Honolulu, Department of Planning & Permitting Subdivision Rules and Regulations.

City & County of Honolulu, Revised Ordinances of Honolulu Section 14-14.2 Application for a Grading Permit.

Handbook of Steel, Drainage & Highway Construction, American Iron and Steel Institute, 1983.

King County, Washington, Department of Natural Resources and Parks, Surface Water Design Manual, Jan 24, 2005.

Proposed Guidance Specifying Management Measures for Sources of Nonpoint Pollution in Coastal Waters, Work Group Working Paper, USEPA, April, 1992.

State of Hawaii, Department of Transportation- Highway Division, Storm Water Permanent Best Management Practices Manual, March 2007.

Stormwater Management Water for the Puget Sound Basin, Washington State Department of Ecology, The Technical Manual- February 1992, Publication #91-75.

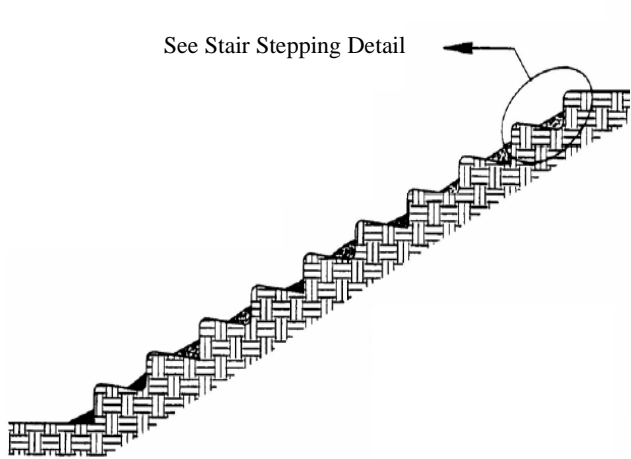

Stair Step Grading
Not to Scale

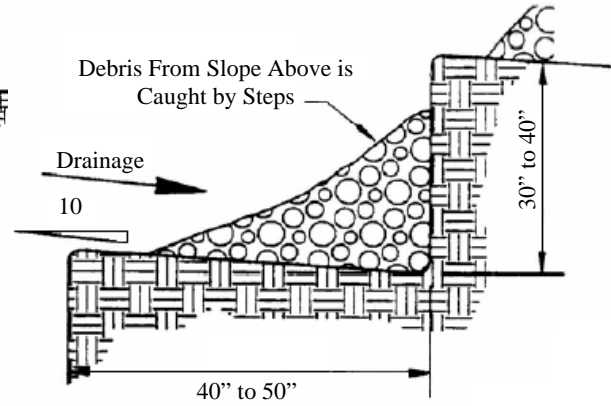

Stair Stepping Detail "A"
Not to Scale

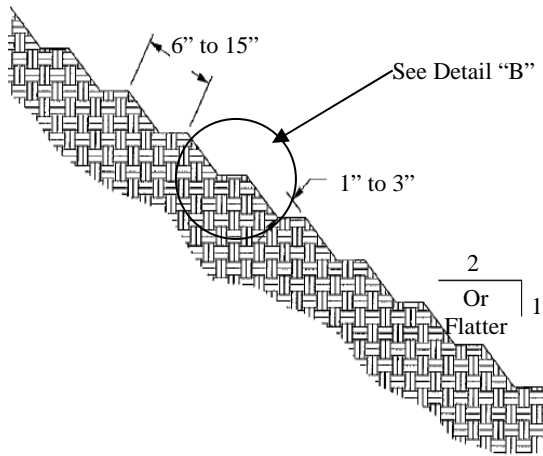

Grooving
Not to Scale

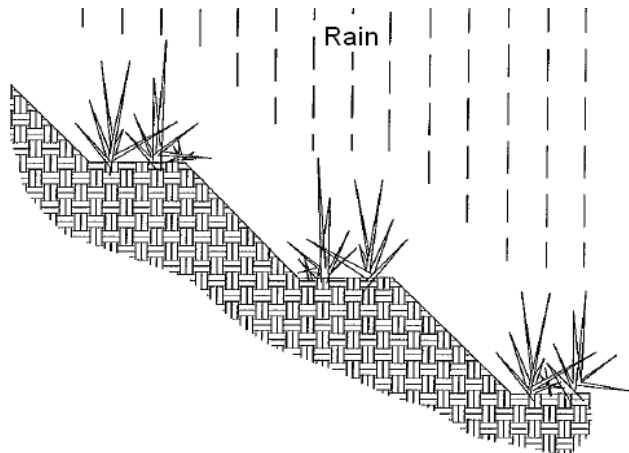

Grooving Detail "B"
Not to Scale

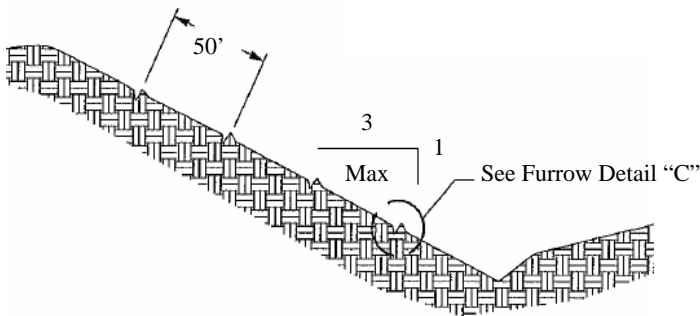

Furrowing
Not to Scale

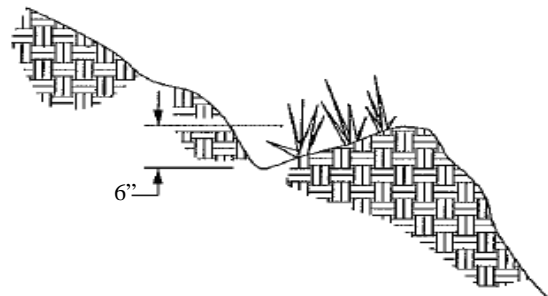

Furrow Detail "C"
Not to Scale

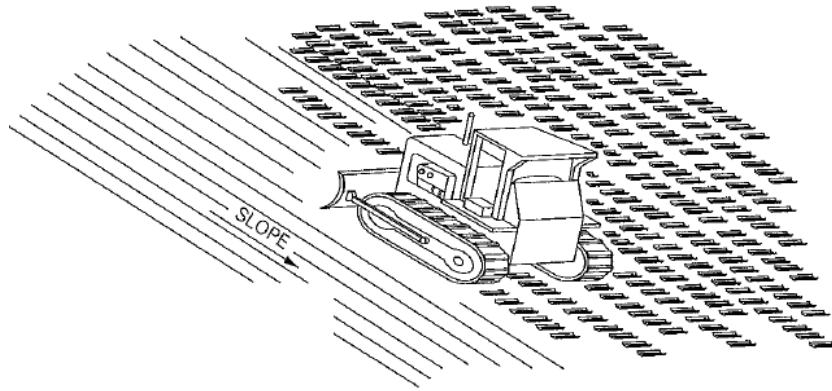

Tracking

Not to Scale

Notes:

1. Surface roughening may be applied to all slopes steeper than 3:1, and greater than 5 vertical feet.
2. Slope hazard analysis is required for cut and fill slopes greater than 15 feet in height and a grade steeper than 40% or 2.5:1 (H:V).
3. Maximum slope cannot exceed 40% and any filling of lot cannot exceed 5 feet in depth.
4. Stairs should be wide enough to work with standard earth moving equipment.
5. Terraces should be designed by a licensed professional engineer.
6. Graded areas steeper than 3:1 should be stair-stepped with benches (Stair Step Grading).
7. Avoid excessive compacting of the soil surface when scarifying.



Description and Purpose

Reuse of native topsoil and other selected materials during revegetation activities. Salvaging, stockpiling, and reapplication of native topsoil are integral to successful revegetation efforts, especially for the reestablishment of native vegetation.

Suitable Applications

This BMP should be applied for the following conditions:

- Reestablishment of areas where vegetation with native plant species is desirable.
- Appropriate for sensitive habitat areas, floodplains, wetlands, and stream banks.

Limitations

- Stockpiles may limit the area available for construction activity.
- Runoff from stockpiles may adversely impact water quality.

Implementation

Consideration of the following items is necessary when developing a topsoil management plan:

- Quality and amount of native topsoil or growth medium.
- Area of surface disturbance to which topsoil or growth medium will be applied and the recommended depth of application.
- Methodology for salvaging topsoil or growth medium.

Objectives

- EC – Erosion Control ✓
- SE – Sediment Control ▲
- TR – Tracking Control
- WE – Wind Erosion Control ▲
- NS – Non-Storm Water Management Control
- WM – Waste Management & Materials Pollution Control

Legend:

- ✓ Primary Objective
- ▲ Secondary Objective

Targeted Constituents

- Sediment ✓
- Nutrients
- Trash
- Metals
- Bacteria
- Oil and Grease
- Organics

Potential Alternatives

None

- Stockpile location, duration of storage, and required erosion control measures to protect stockpile.
- Feasibility of direct application of salvaged soils.
- Availability of other growth media to supplement topsoil reclamation.

Installation

- Conduct a site-specific soil survey of the area prior to soil disturbing activities to assess the location, depth, and amount of soils suitable for salvaging.
- Salvage and stockpile all suitable topsoil and other material for future use during revegetation of the area. Stockpile material in an area free of contamination from demolition or construction activities.
- Refer to WM-3 (Stockpile Management) in this manual when stockpiling salvaged topsoil.
- Carefully remove shrubs suitable for revegetation and store with the roots covered with mulch or loose soil.
- Cover or stabilize soil stockpiles with temporary measures such as mulch or temporary vegetation.
- Apply topsoil or growth medium directly to disturbed areas when practicable.
- Soil replacement depths are determined by factors such as soil depth prior to disturbance, type of vegetation, and physical and/or chemical properties of the material to be covered. A deeper soil layer is recommended for soils with poor physical and chemical properties. Testing (nutrients, pH, and toxicity factors) of replacement soils and material to be covered should be completed prior to reapplication.

Inspection and Maintenance

- Regularly inspect stockpiles for erosion and stabilize as necessary.
- Inspect stockpile covers to ensure adequate protection from wind and rain.
- Adequately water plantings until they are established.

Costs

All of the above are low cost measures.

References

State of Hawaii DOT, Highways Division Construction BMP Field Manual, September 2006.

Truckee Meadows Construction Best Management Practices Handbook, 2003.

3.8 SEDIMENT CONTROL FACT SHEETS

- SE-1 Silt Fence
- SE-2 Sediment Basin
- SE-3 Sediment Trap
- SE-4 Check Dams
- SE-5 Fiber Rolls
- SE-6 Gravel Bag Berm
- SE-7 Street Sweeping and Vacuuming
- SE-8 Sandbag Barrier
- SE-10 Storm Drain Inlet Protection
- SE-11 Chemical Treatment
- SE-12 Location of Potential Sources of Sediment
- SE-13 Level Spreader
- SE-14 Rip-Rap & Gabion Inflow Protection
- SE-15 Vegetated Buffer Strips and Channels
- SE-16 Compost Socks and Berms



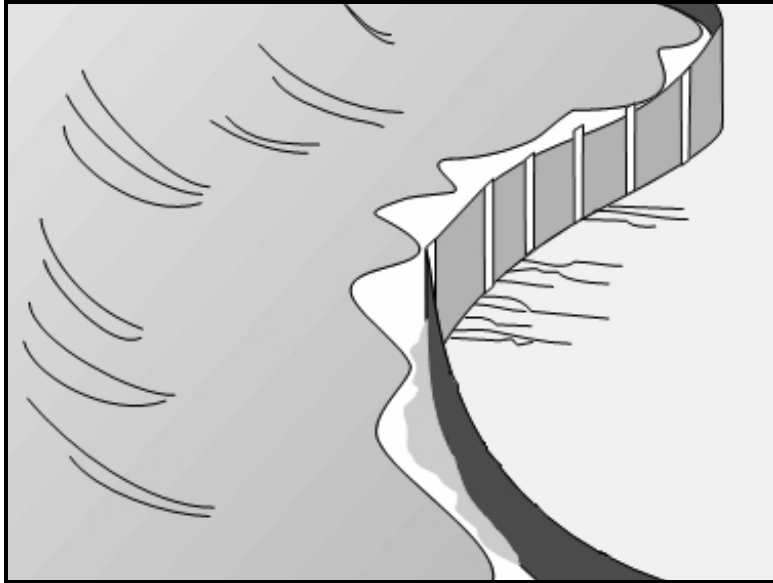

Description and Purpose

A silt fence is made of a filter fabric that has been entrenched, attached to supporting poles, and sometimes backed by a plastic or wire mesh for support. The silt fence detains sediment-laden water, promoting sedimentation behind the fence.

Suitable Applications

Silt fences are suitable for perimeter control, placed below areas where sheet flows discharge from the site. They should also be used as interior controls below disturbed areas where runoff may occur in the form of sheet and rill erosion. Silt fences are generally ineffective in locations where the flow is concentrated and are only applicable for sheet or overland flows. Silt fences are most effective when used in combination with erosion controls. Suitable applications include:

- Along the perimeter of a project. Consider embedding the perimeter dust screen fabric and jointly using it as the perimeter silt fence;
- Below the toe or down slope of exposed and erodible slopes;
- Along streams and channels;
- Around temporary spoil areas and stockpiles; and
- Below other small cleared areas.

Limitations

- Do not use in streams, channels, drain inlets, or anywhere flow is concentrated.

Objectives

EC – Erosion Control	
SE – Sediment Control	√
TR – Tracking Control	
WE – Wind Erosion Control	
NS – Non-Storm Water Management Control	
WM – Waste Management & Materials Pollution Control	

Legend:

- √ Primary Objective
- ▲ Secondary Objective

Targeted Constituents

Sediment	√
Nutrients	
Trash	
Metals	
Bacteria	
Oil and Grease	
Organics	

Potential Alternatives

- SE-5 Fiber Rolls
- SE-6 Gravel Bag Berm
- SE-8 Sandbag Barrier

- Do not use in locations where ponded water may cause flooding.
- Do not place fence on a slope, or across any contour line. If not installed at the same elevation throughout, silt fences will create erosion.
- Filter fences will create a temporary sedimentation pond on the upstream side of the fence and may cause temporary flooding. Fences not constructed on a level contour will be overtopped by concentrated flow resulting in failure of the filter fence.
- Improperly installed fences are subject to failure from undercutting, overlapping, or collapsing.
 - Not effective unless trenched and keyed in.
 - Not intended for use as mid-slope protection on slopes greater than 4:1 (H:V).
 - Do not allow water depth to exceed 1.5 ft. at any point.

Implementation

General

A silt fence is a temporary sediment barrier consisting of filter fabric stretched across and attached to supporting posts, entrenched, and, depending upon the strength of fabric used, supported with plastic or wire mesh fence. Silt fences trap sediment by intercepting and detaining small amounts of sediment-laden runoff from disturbed areas in order to promote sedimentation behind the fence.

Silt fences are preferable to straw bale barriers in many cases. Laboratory work at the Virginia Highway and Transportation Research Council has shown that silt fences can trap a much higher percentage of suspended sediments than can straw bales. While the failure rate of silt fences is lower than that of straw bale barriers, there are many instances where silt fences have been improperly installed. The following layout and installation guidance can improve performance and should be followed:

- Use principally in areas where sheet flow occurs;
- Don't use in streams, channels, or anywhere flow is concentrated. Don't use silt fences to divert flow;
- Don't use below slopes subject to creep, slumping, or landslides;
- Select filter fabric that retains 85% of soil by weight, based on sieve analysis, but that is not finer than an equivalent opening size of 70;
- Install along a level contour, so water does not pond more than 1.5 ft. at any point along the silt fence;
- The maximum length of slope draining to any point along the silt fence should be 200 ft. or less;
- The maximum slope perpendicular to the fence line should be 1:1;
- Provide sufficient room for runoff to pond behind the fence and to allow sediment removal equipment to pass between the silt fence and toes of slopes or other obstructions. About 1200 ft² of ponding area should be provided for every acre draining to the fence;
- Turn the ends of the filter fence uphill to prevent storm water from flowing around the fence;

- Leave an undisturbed or stabilized area immediately down slope from the fence where feasible; and
- Silt fences should remain in place until the disturbed area is permanently stabilized.

Design and Layout

Selection of a filter fabric is based on soil conditions at the construction site (which affect the equivalent opening size (EOS) fabric specification) and characteristics of the support fence (which affect the choice of tensile strength). The designer should specify a filter fabric that retains the soil found on the construction site yet that it has openings large enough to permit drainage and prevent clogging. The following criteria are recommended for selection of the equivalent opening size:

- If 50 percent or less of the soil, by weight, will pass the U.S. Standard Sieve No. 200, select the EOS to retain 85% of the soil. The EOS should not be finer than EOS 70; and
- For all other soil types, the EOS should be no larger than the openings in the U.S. Standard Sieve No. 70 except where direct discharge to a stream, lake, or wetland will occur, then the EOS should be no larger than Standard Sieve No. 100.

To reduce the chance of clogging, it is preferable to specify a fabric with openings as large as allowed by the criteria. No fabric should be specified with an EOS smaller than U.S. Standard Sieve No. 100. If 85% or more of a soil, by weight, passes through the openings in a No. 200 sieve, filter fabric should not be used. Most of the particles in such a soil would not be retained if the EOS was too large and they would clog the fabric quickly if the EOS were small enough to capture the soil.

The fence should be supported by a plastic or wire mesh if the fabric selected does not have sufficient strength and bursting strength characteristics for the planned application (as recommended by the fabric manufacturer). Filter fabric material should contain ultraviolet inhibitors and stabilizers to provide a minimum of six months of expected usable construction life at a temperature range of 0°F to 120°F.

- Layout in accordance with attached figures.
- For slopes steeper than 2:1 (H:V) and that contain a high number of rocks or large dirt clods that tend to dislodge, it may be necessary to install additional protection immediately adjacent to the bottom of the slope, prior to installing silt fence. Additional protection may be a chain link fence or a cable fence.
- For slopes adjacent to sensitive receiving waters or Environmentally Sensitive Areas (ESAs), silt fence should be used in conjunction with erosion control BMPs.

Materials

- Silt fence fabric should be composed of a permeable geotextile filter fabric with a minimum width of 36 in. and a minimum tensile strength of 100 lb force. The fabric should conform to the requirements in ASTM designation D4632 and should have an integral reinforcement layer. The reinforcement layer should be a polypropylene, or equivalent, net provided by the manufacturer.
- Wood stakes should be commercial quality lumber of the size and shape shown on the plans. Each stake should be free from decay, splits or cracks longer than the thickness of

the stake or other defects that would weaken the stakes and cause the stakes to be structurally unsuitable.

- Staples used to fasten the fence fabric to the stakes should be not less than 1.75 in. long and should be fabricated from 15 gauge or heavier wire. The wire used to fasten the tops of the stakes together when joining two sections of fence should be 9 gauge or heavier wire. Galvanizing of the fastening wire will not be required.
- There are new products that may use prefabricated plastic or metal stakes with holders for the silt fence and use bar reinforcement instead of wood stakes. If bar reinforcement is used in lieu of wood stakes, use number four or greater bar. Provide end protection for any exposed bar reinforcement.

Installation Guidelines

Silt fences are to be constructed on a level contour. Sufficient area should exist behind the fence for ponding to occur without flooding or overtopping the fence.

- A trench should be excavated approximately 6 in. wide and 6 in. deep along the line of the proposed silt fence.
- Bottom of the silt fence should be keyed-in a minimum of 12 in.
- Posts should be spaced a maximum of 6 ft. apart and driven securely into the ground a minimum of 18 in. or 12 in. below the bottom of the trench. Fabric should be installed on the upslope face of the posts.
- When standard strength filter fabric is used, a plastic or wire mesh support fence should be fastened securely to the upslope side of posts using heavy-duty wire staples at least 1 in. long. The mesh should extend into the trench.
- When extra-strength filter fabric and closer post spacing are used, the mesh support fence may be eliminated.
- Filter fabric should be purchased in a long roll, and then cut to the length of the barrier. When joints are necessary, filter cloth should be spliced together only at a support post, with a minimum 6 in. overlap and both ends securely fastened to the post.
- The trench should be backfilled with compacted native material.
- Construct silt fences with a setback of at least 3 ft. from the toe of a slope. Where a silt fence is determined to be not practicable due to specific site conditions, the silt fence may be constructed at the toe of the slope, but should be constructed as far from the toe of the slope as practicable. Silt fences close to the toe of the slope will be less effective and difficult to maintain.
- Construct the length of each reach so that the change in base elevation along the reach does not exceed 1/3 the height of the barrier; in no case should the reach exceed 500 ft.

Costs

- Average annual cost for installation and maintenance (assumes 6 month useful life) in California: \$7 per lineal foot (\$850 per drainage acre). Range of cost is \$3.50 - \$9.10 per lineal foot. Note that Hawaii's unit prices are higher than California's unit prices.

Inspection and Maintenance

- Inspect BMPs prior to forecast rain, daily during extended rain events, after rain events, weekly during the rainy season, and at two-week intervals during the non-rainy season.
- Repair undercut silt fences.
- Repair or replace split, torn, slumping, or weathered fabric. The lifespan of silt fence fabric is generally 5 to 8 months.
- Silt fences that are damaged and become unsuitable for the intended purpose should be removed from the site of work, disposed of, and replaced with new silt fence barriers.
- Sediment that accumulates in the BMP should be periodically removed in order to maintain BMP effectiveness. Sediment should be removed when the sediment accumulation reaches one-third of the barrier height. Sediment removed during maintenance may be incorporated into earthwork on the site or disposed at an appropriate location.
- Silt fences should be left in place until the upstream area is permanently stabilized. Until then, the silt fence should be inspected and maintained.
- Holes, depressions, or other ground disturbance caused by the removal of the silt fences should be backfilled and repaired.

References

California Stormwater Quality Association (CASQA) Best Management Practices Handbook Construction, 2003.

Manual of Standards of Erosion and Sediment Control Measures, Association of Bay Area Governments, May 1995.

National Management Measures to Control Nonpoint Source Pollution from Urban Areas, United States Environmental Protection Agency, 2002.

Proposed Guidance Specifying Management Measures for Sources of Nonpoint Pollution in Coastal Waters, Work Group-Working Paper, USEPA, April 1992.

Sedimentation and Erosion Control Practices, and Inventory of Current Practices (Draft), USEPA, 1990.

Southeastern Wisconsin Regional Planning Commission (SWRPC). Costs of Urban Nonpoint Source Water Pollution Control Measures. Technical Report No. 31. Southeastern Wisconsin Regional Planning Commission, Waukesha, WI, 1991.

Storm Water Management Manual for The Puget Sound Basin, Washington State Department of Ecology, Public Review Draft, 1991.

Stormwater Quality Handbooks Construction Site Best Management Practices (BMPs) Manual, State of California Department of Transportation (Caltrans), November 2000.

U.S. Environmental Protection Agency (USEPA). Stormwater Management for Industrial Activities: Developing Pollution Prevention Plans and Best Management Practices. U.S. Environmental Protection Agency, Office of Water, Washington, DC, 1992.

Water Quality Management Plan for the Lake Tahoe Region, Volume II, Handbook of Management Practices, Tahoe Regional Planning Agency, November 1988.

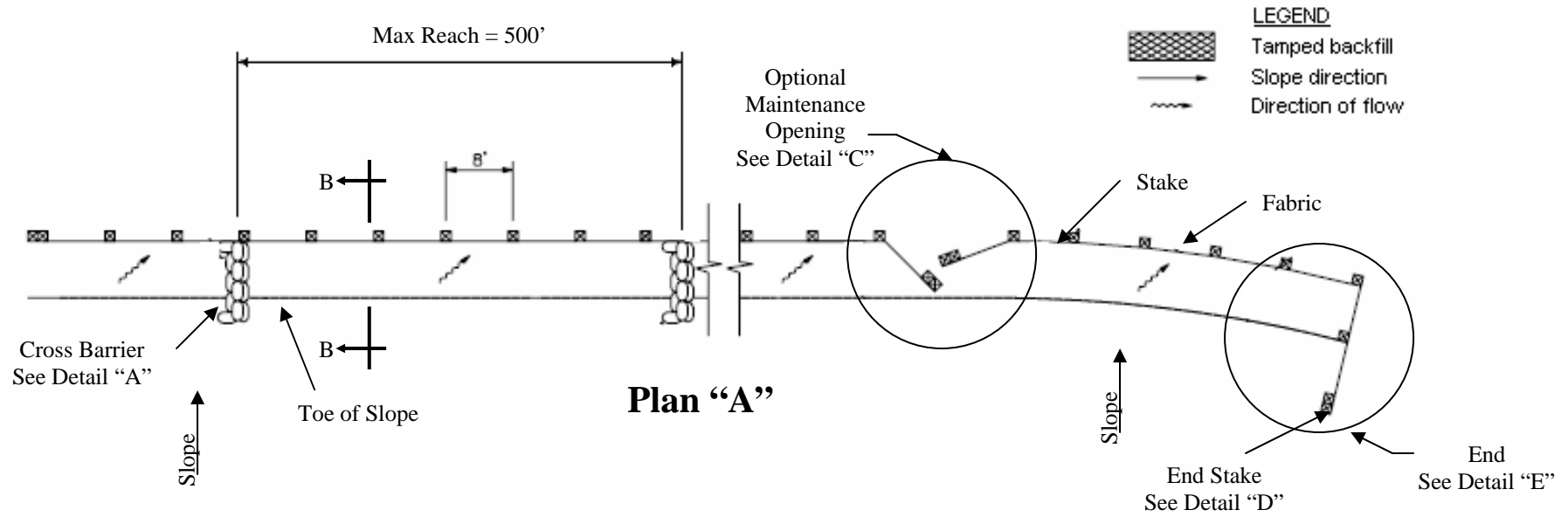

Notes:

1. Construct the length of each reach so that the change in base elevation along the reach does not exceed 1/3 the height of the linear barrier, in no case shall the reach length exceed 500'.
2. Cross barriers shall be a minimum of 1/3 and a maximum of 1/2 the height of the linear barrier.
3. Sandbag rows and layers shall be offset to eliminate gaps.
4. Setback dimension may vary to fit field condition. Typical 3' setback from top of slope.
5. Stakes shall be spaced at 8' maximum and shall be positioned on downstream side of fence, or as specified by the engineer.
6. Stake dimensions are nominal. Material as specified by engineer.
7. Stakes to overlap and fence fabric to fold around each stake one full turn. Secure fabric to stake with 4 staples or wire.
8. Stakes shall be driven tightly together to prevent potential flow-through of sediment at joint. The tops of the stakes shall be secured with wire.
9. For end stake, fence fabric shall be folded around two stakes one full turn and secured with 4 staples or wire.
10. Minimum 4 staples or wire per stake. Dimensions shown are typical.
11. Joining sections shall not be placed at sump locations.
12. Maintenance openings shall be constructed in a manner to ensure sediment remains behind silt fence.
13. The last 8' of fence shall be turned up slope to reduce breakthrough of sediment.

Silt Fence

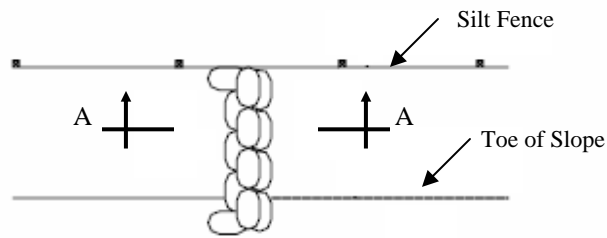

CROSS BARRIER DETAIL "A"

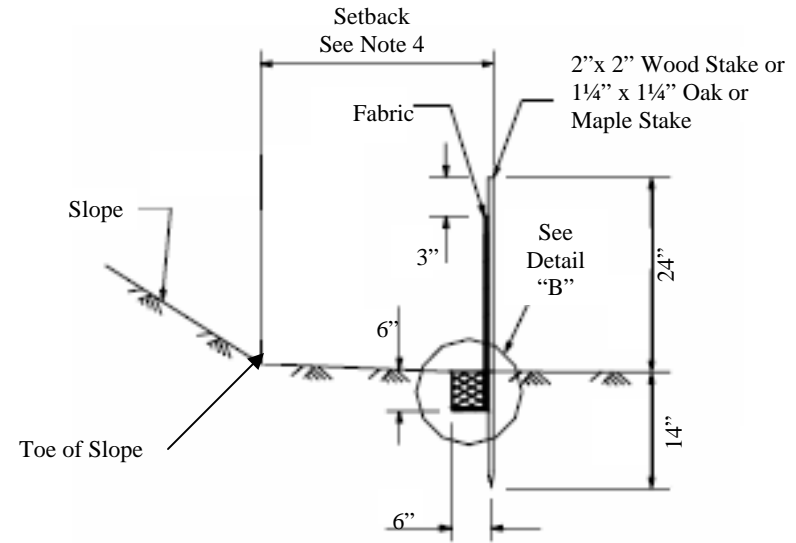

SECTION B-B

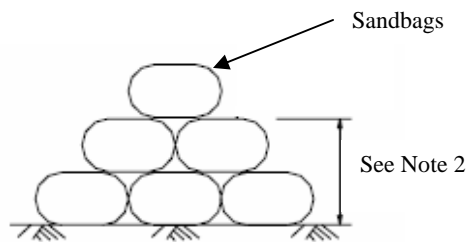

SECTION A-A

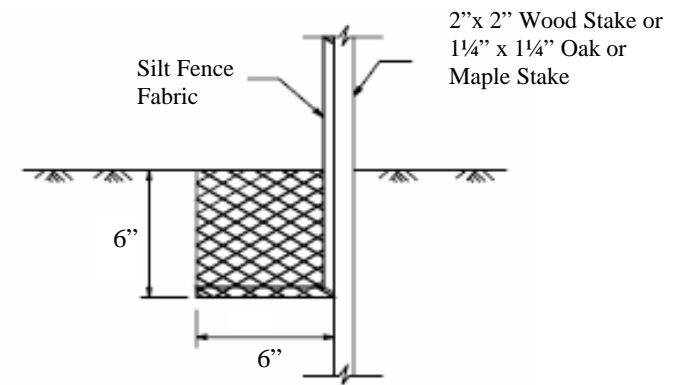

DETAIL "B"

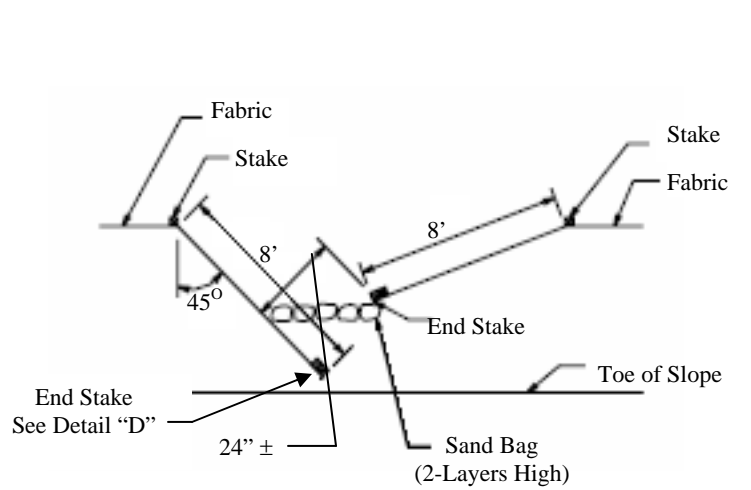

OPTIONAL MAINTENANCE OPENING DETAIL "C"

See note 12

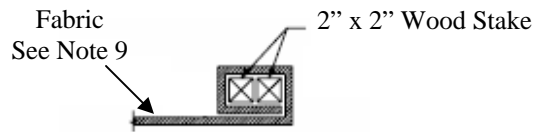

END STAKE DETAIL "D"
(TOP VIEW)

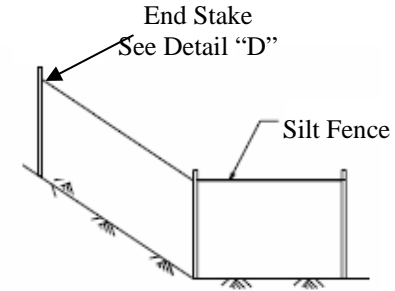

END DETAIL "E"

See note 2

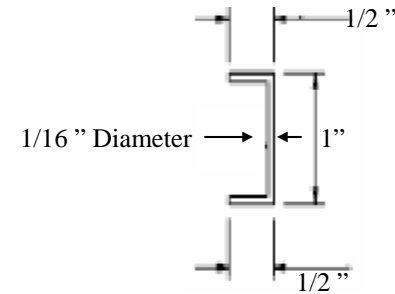

STAPLE DETAIL

"T"

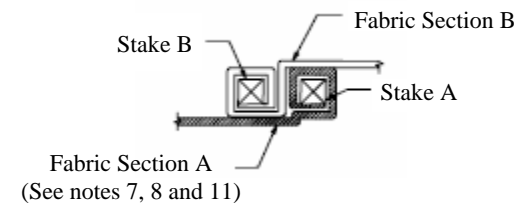

JOINING SECTION DETAIL "G"
TOP VIEW

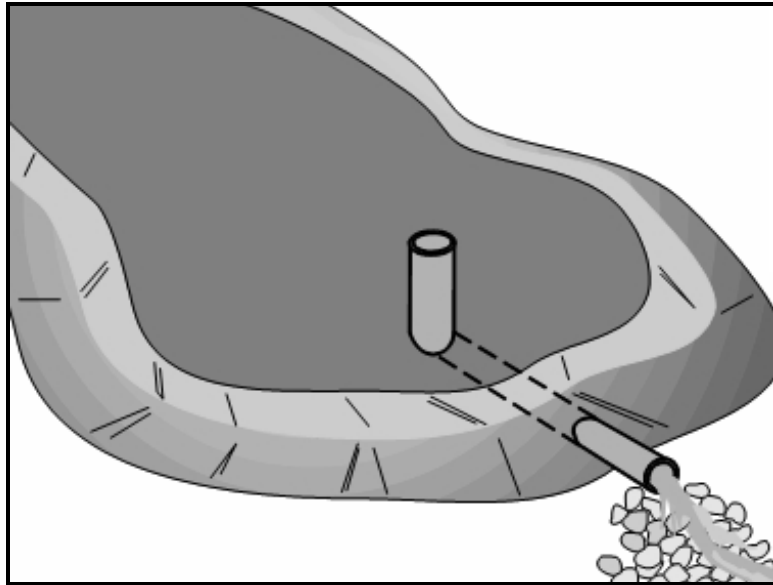

Description and Purpose

A sediment basin is a temporary basin formed by excavation or by constructing an embankment so that sediment-laden runoff is temporarily detained under quiescent conditions, allowing sediment to settle out before the runoff is discharged.

Suitable Applications

Sediment basins may be suitable for use on larger projects with sufficient space for constructing the basin. Sediment basins should be considered for use:

- Where sediment-laden water may enter the drainage system or watercourses;
- On construction projects with disturbed areas during the rainy season;
- At the outlet of disturbed watersheds between 5 acres and 75 acres;
- At the outlet of large disturbed watersheds, as necessary;
- Where post construction detention basins are required; or
- In association with dikes, temporary channels, and pipes used to convey runoff from disturbed areas.

Limitations

Sediment basins must be installed only within the property limits and where failure of the structure will not result in loss public roads or utilities. In addition, sediment basins are attractive to children and can be very dangerous. State NPDES Notice of General Permit coverage (DOH NOI-C 8.b.iv. (1) (a)) regarding

Objectives

- EC – Erosion Control
- SE – Sediment Control ✓
- TR – Tracking Control
- WE – Wind Erosion Control
- NS – Non-Storm Water Management Control
- WM – Waste Management & Materials Pollution Control

Legend:

- ✓ Primary Objective
- ▲ Secondary Objective

Targeted Constituents

- Sediment ✓
- Nutrients
- Trash ✓
- Metals
- Bacteria
- Oil and Grease
- Organics

Potential Alternatives

- SE-3 Sediment Trap (for smaller areas)

health and safety must be adhered to. If fencing of the basin is required, the type of fence and its location should be shown in the site-specific BMPs plan and in the construction specifications.

- Generally, sediment basins are limited to drainage areas of 5 acres or more, but not appropriate for drainage areas greater than 75 acres.
- Sediment basins may become an “attractive nuisance” and care must be taken to adhere to all safety practices. Since safety is a concern, a basin may include protective fencing, lockable grates at top of riser inlets to restrict access in pipe.
- Sediment basins designed according to this manual are only practically effective in removing sediment down to about the medium silt size fraction. Sediment-laden runoff with smaller size fractions (fine silt and clay) may not be adequately treated unless chemical treatment is used in addition to the sediment basin.
- Sites with very fine sediments (fine silt and clay) may require longer detention times for effective sediment removal.
- Basins with a height of 25 ft. or more or an impounding capacity of 50 ac-ft or more must obtain approval from State of Hawaii Department of Land and Natural Resources (HAR 13-179 Dams & Reservoirs).
- Standing water may cause mosquitoes or other pests to breed.
- Basins require large surface areas to permit settling of sediment. Size may be limited by the available area.
- Basins in excess of certain depth and storage volume criteria must meet State Department of Land and Natural Resources (HAR 13-190 Dams and Reservoirs) safety requirements.

Implementation

General

A sediment basin is a controlled storm water release structure formed by excavation or by construction of an embankment of compacted soil across a drainage way, or other suitable location. It is intended to trap sediment before it leaves the construction site. The basin is a temporary measure with a design life of 12 to 28 months in most cases and is to be maintained until the site area is permanently protected against erosion or a permanent detention basin is constructed.

Sediment basins are suitable for nearly all types of construction projects. Whenever possible, construct the sediment basins before clearing and grading work begins. Basins should be located at the storm water outlet from the site but not in any natural or undisturbed stream. A typical application would include temporary dikes, pipes, and/or channels to divert runoff to the basin inlet.

Many development projects in the City and County of Honolulu will be required by the Rules Relating to Storm Drainage Standards (2000) to provide a storm water detention basin for post-construction flood control, desilting, or storm water pollution control. A temporary sediment basin may be constructed by rough grading the post-construction control basins early in the project.

Sediment basins trap 70-80% of the sediment that flows into them if designed according to this manual. Therefore, they should be used in conjunction with erosion control practices such as

temporary seeding, mulching, diversion dikes, etc., to reduce the amount of sediment flowing into the basin.

Planning

To improve the effectiveness of the basin, it should be located to intercept runoff from the largest possible amount of disturbed area. The best locations are generally low areas. Drainage into the basin can be improved by the use of earth dikes and drainage swales (EC-9). The basin must not be located in a stream but it should be located to trap sediment-laden runoff before it enters the stream. The basin should not be located where its failure would result in the loss of life or interruption of the use or service of public utilities or roads.

- Construct before clearing and grading work begins when feasible.
- Do not locate in a stream.
- Basin sites should be located where failure of the structure will not cause loss of life, damage to homes or buildings, or interruption of use or service of public roads or utilities.
- Large basins are subject to state and State DLNR dam safety requirements.
- Limit the contributing area to the sediment basin to only the runoff from the disturbed soil areas. Use temporary concentrated flow conveyance controls to divert runoff from undisturbed areas away from the sediment basin.
- The basin should be located: (1) by excavating a suitable area or where a low embankment can be constructed across a swale, (2) where post-construction (permanent) detention basins will be constructed, and (3) where the basins can be maintained on a year-round basis to provide access for maintenance, including sediment removal and sediment stockpiling in a protected area, and to maintain the basin to provide the required capacity.

Design

Sediment basins must be designed in accordance with State of Hawaii Department of Health, Clean Water Branch (CWB) NPDES General Permit Coverage Notice of Intent (NOI) Form C Authorizing Discharge of Storm Water Associated with Construction Activities where sediment basins are the only control measure proposed for the site. If there is insufficient area to construct a sediment basin in accordance with the CWB NOI Form C requirements, then the alternate design standards specified herein may be used.

Sediment basins designed per CWB NOI Form C shall be designed as follows:

For Drainage Areas Greater than 10 Acres:

For common drainage locations that serve an area with 10 or more acres disturbed at one time, a temporary (or permanent) sediment basin that provides storage for a calculated volume of runoff from the drainage area from a 2-year, 24-hour storm, or equivalent control measures, must be provided where attainable until final stabilization of the site. This requirement is specified in both the City & County of Honolulu –Department of Planning and Permitting Rules Relating to Soil Erosion Standards and Guidelines (April 1999). When computing the number of acres draining into a common location, it is not necessary to include flows from offsite areas and flows from on-site areas that are either undisturbed or have undergone final stabilization where such flows are diverted around both the disturbed area and the sediment basin. In determining

whether installing a sediment basin is attainable, the operator may consider factors such as site soils, slope, available area on-site, etc. In any event, the operator must consider public safety, especially as it relates to children, as a design factor for the sediment basin, and alternative sediment controls must be used where site limitations would preclude a safe design.

For drainage locations which serve 10 or more disturbed acres at one time and where a temporary sediment basin or equivalent controls is not attainable, smaller sediment basins and/or sediment traps (SE-3) should be used. At a minimum, silt fences (SE-1), vegetative buffer strips (SE-15), or equivalent sediment controls are required for all down slope boundaries (and for those side slope boundaries deemed appropriate as dictated by individual site conditions).

For Drainage Areas Less than 10 Acres:

Smaller sediment basins and/or sediment traps (SE-3) should be used. At a minimum, silt fences (SE-1), vegetative buffer strips (SE-15), or equivalent sediment controls are required for all down slope boundaries (and for those side slope boundaries deemed appropriate as dictated by individual site conditions) of the construction area unless a sediment basin providing storage for a calculated volume of runoff from a 2-year, 24-hour storm is provided.

Other design considerations are:

- The draw-down (or draining) time for the detention volume, which is intended to drain down completely (vs. permanent wet volume), shall be between 48 and 72 hours. For bottom half of the detention volume, the draw-down time shall be greater than or equal to 36 to 72 hours. The 48 and 36 hour limit is specified to provide adequate settling time; the 72-hour limit is specified to mitigate vector control concerns.
- For detention based water quality controls with less than or equal to 20 acres of drainage area, the total draw-down time can be reduced to 36 hours, with the lower half of the detention volume draw-down time of 24 hours, if it can be demonstrated that the outlet sizing (e.g., outlet pipe diameter less than 4 inches) would not be practical.
- The detention system shall be designed to maximize the distance between the inlet and outlet, and to minimize “dead spaces” (areas where little or no exchange occurs during a storm event), there-by limiting short-circuiting. A minimum flow-path length to width ratio of 3 should be utilized.
- The outlet shall be sized to achieve the above required detention times. In addition, it shall be large enough that clogging is unlikely to occur. It should be 4 inches or larger in diameter. Alternative hydraulic structures can be accepted with computations and approval by the City DPP.
- Recommended maximum side slope of 3:1 (H:V).
- A detention time of 24 to 40 hours should allow 70 to 80% of sediment to settle.
- The basin volume consists of two zones:
 - A sediment storage zone at least 1 ft. deep, and
 - A settling zone at least 2 ft. deep.
- The depth must be no less than 3 ft.
- The length to settling depth ratio (L/SD) should be less than 200.

- Sediment basins are best used in conjunction with erosion controls. Sediment basins that will be used as the only means of treatment, without upstream erosion and sediment controls, must be designed to the satisfaction of CWB NOI Form C. Sediment basins that are used in conjunction with upstream erosion and sediment controls should be designed to have a capacity equivalent to 67 yd³ of sediment storage per acre of contributory area.
- Basins with an impounding levee greater than 4.5 ft. tall, measured from the lowest point to the impounding area to the highest point of the levee, and basins capable of impounding more than 35,000 ft³, should be designed by a Licensed Civil Engineer. The design should include maintenance requirements, including sediment and vegetation removal, to ensure continuous function of the basin outlet and bypass structures.
- Sediment basins, regardless of size and storage volume, should include features to accommodate overflow or bypass flows that exceed the design storm event.
 - Include an emergency spillway to accommodate flows not carried by the principal spillway. The spillway should consist of an open channel (earthen or vegetated) over undisturbed material (not fill) or constructed of a non-erodible riprap.
 - The spillway control section, which is a level portion of the spillway channel at the highest elevation in the channel, should be a minimum of 20 ft. in length.
- Rock or vegetation should be used to protect the basin inlet and slopes against erosion.
- A forebay, constructed upstream of the basin may be provided to remove debris and larger particles.
- Consider using biodegradable flocculants (chitosan) to enhance sedimentation of finer suspended matters.
- The outflow from the sediment basin should be provided with velocity dissipation devices (EC-10) to prevent erosion and scouring of the embankment and channel.
- Basin inlets should be located to maximize travel distance to the basin outlet.
- The principal outlet should consist of a corrugated metal, high density polyethylene (HDPE), or reinforced concrete riser pipe with dewatering holes and an anti-vortex device and trash rack attached to the top of the riser, to prevent floating debris from flowing out of the basin or obstructing the system. This principal structure should be designed to accommodate the inflow design storm.
- A rock pile or rock-filled gabions can serve as alternatives to the debris screen; although the designer should be aware of the potential for extra maintenance involved should the pore spaces in the rock pile clog.
- The outlet structure should be placed on a firm, smooth foundation with the base securely anchored with concrete or other means to prevent floatation.
- Attach riser pipe (watertight connection) to a horizontal pipe (barrel). Provide anti-seep collars on the barrel.
- Cleanout level should be clearly marked on the riser pipe.

- The two most common outlet problems that occur are: (1) the capacity of the outlet is too great resulting in only partial filling of the basin and drawdown time less than designed for; and (2) the outlet clogs because it is not adequately protected against trash and debris. To avoid these problems, the following outlet types are recommended for use: (1) a single orifice outlet with or without the protection of a riser pipe, and (2) perforated riser. Design guidance for single orifice and perforated riser outlets follow:
 - Flow Control Using a Single Orifice At The Bottom Of The Basin (Figure 1): The outlet control orifice should be sized using the following equation:

$$a = \frac{2A(H - H_o)^{0.5}}{3600CT(2g)^{0.5}} = \frac{(7 \times 10^{-5})A(H - H_o)^{0.5}}{CT} \quad (\text{Eq. 2})$$

where:

a = area of orifice (ft²)

A = surface area of the basin at mid elevation (ft²)

C = orifice coefficient

T = drawdown time of full basin (hrs.)

g = gravity (32.2 ft/s²)

H = elevation when the basin is full (ft.)

H_o = final elevation when basin is empty (ft.)

With a drawdown time of 40 hours, the equation becomes:

$$a = \frac{(1.75 \times 10^{-6})A(H - H_o)^{0.5}}{C} \quad (\text{Eq. 3})$$

- Flow Control Using Multiple Orifices (see Figure 2):

$$a_t = \frac{2A(h_{\max})}{3600CT(2g[h_{\max} - h_{\text{centroid of orifices}}])^{0.5}} \quad (\text{Eq. 4})$$

With terms as described above except:

a_t = total area of orifices

h_{max} = maximum height from lowest orifice to the maximum water surface (ft.)

h_{centroid of orifices} = height from the lowest orifice to the centroid of the orifice configuration (ft.)

Allocate the orifices evenly on two rows; separate the holes by 3x hole diameter vertically, and by 120 degrees horizontally (refer to Figure 2).

Because basins are not maintained for infiltration, water loss by infiltration should be disregarded when designing the hydraulic capacity of the outlet structure.

Care must be taken in the selection of "C"; 0.60 is most often recommended and used. However, based on actual tests, GKY (1989), "Outlet Hydraulics of Extended

Detention Facilities for Northern Virginia Planning District Commission", recommends the following:

$C = 0.66$ for thin materials; where the thickness is equal to or less than the orifice diameter, or

$C = 0.80$ when the material is thicker than the orifice diameter

Installation

- Securely anchor and install an anti-seep collar on the outlet pipe/riser and provide an emergency spillway for passing major floods.
- Areas under embankments must be cleared and stripped of vegetation.
- Chain link fencing should be provided around each sediment basin to prevent unauthorized entry to the basin or if safety is a concern.

Costs

Average annual costs for installation and maintenance (2 year useful life) in California are:

- Basin less than 50,000 ft³: Range, \$0.24 - \$1.58/ft³. Average, \$0.73 per ft³. \$400 - \$2,400, \$1,200 average per drainage acre; and
- Basin size greater than 50,000 ft³: Range, \$0.12 - \$0.48/ft³. Average, \$0.36 per ft³. \$200 - \$800, \$600 average per drainage acre.

Note that Hawaii's unit prices are higher than California's unit prices.

Inspection and Maintenance

- Inspect BMPs prior to forecast rain, daily during extended rain events, after rain events, weekly during the rainy season, and at two-week intervals during the non-rainy season.
- Examine basin banks for seepage and structural soundness.
- Check inlet and outlet structures and spillway for any damage or obstructions. Repair damage and remove obstructions as needed.
- Check inlet and outlet area for erosion and stabilize if required.
- Check fencing for damage and repair as needed.
- Sediment that accumulates in the BMP must be periodically removed in order to maintain BMP effectiveness. Sediment should be removed when sediment accumulation reaches one-half the designated sediment storage volume. Sediment removed during maintenance may be incorporated into earthwork on the site or disposed of at appropriate locations.
- Remove standing water from basin within 72 hours after accumulation.
- BMPs that require dewatering shall be continuously attended while dewatering takes place. Dewatering BMPs shall be implemented at all times during dewatering activities.
- To minimize vector production:
 - Remove accumulation of live and dead floating vegetation in basins during every inspection; and
 - Remove excessive emergent and perimeter vegetation as needed or as advised by State Department of Agriculture.

References

California Stormwater Quality Association (CASQA) Best Management Practices Handbook Construction, 2003.

City & County of Honolulu, Rules Relating to Storm Drainage Standards, January 2000.

A Current Assessment of Urban Best Management Practices: Techniques for Reducing Nonpoint Source Pollution in the Coastal Zones, Metropolitan Washington Council of Governments, March 1992.

Draft-Sedimentation and Erosion Control, an Inventory of Current Practices, USEPA. April 1990.

Guidelines for the Design and Construction of Small Embankment Dams, Division of Safety of Dams, California Department of Water Resources, March 1986.

Hawaii Administrative Rules, Chapter 11, Section 55, Water Pollution Control, October 2007.

Hawaii Revised Statutes, Chapter 179D, Dams and Reservoir.

Manual of Standards of Erosion and Sediment Control Measures, Association of Bay Area Governments, May 1995.

McLean, J., 2000. Mosquitoes in Constructed Wetlands: A Management Bugaboo? In T.R. Schueler and H.K. Holland [eds.], *The Practice of Watershed Protection*. pp. 29-33. Center for Watershed Protection, Ellicott City, MD, 2000.

Metzger, M.E., D. F. Messer, C. L. Beitia, C. M. Myers, and V. L. Kramer. The dark site of stormwater runoff management: disease vectors associated with structural BMPs, 2002.

National Management Measures to Control Nonpoint Source Pollution from Urban Areas, United States Environmental Protection Agency, 2002.

Proposed Guidance Specifying Management Measures for Sources of Nonpoint Pollution in Coastal Water, Work Group-Working Paper, USEPA, April 1992.

Hawaii Administrative Rules, Title 11, Chapter 55, Appendix C, State of Hawaii Department of Health, Clean Water Branch NPDES General Permit Coverage Notice of Intent (NOI) Form C Authorizing Discharge of Storm Water Associated with Construction Activities.

Hawaii Administrative Rules, Title 13, Subtitle 7, Chapter 190, Dams and Reservoirs.

Stormwater Management of the Puget Sound Basin, Technical Manual, Publication #91-75, Washington State Department of Ecology, February 1992.

Stormwater Quality Handbooks - Construction Site Best Management Practices (BMPs) Manual, State of California Department of Transportation (Caltrans), November 2000.

U.S. Environmental Protection Agency (USEPA). Guidance Specifying Management Measures for Nonpoint Pollution in Coastal Waters. EPA 840-B-9-002. U.S. Environmental Protection Agency, Office of Water, Washington, DC, 1993.

Water Quality Management Plan for the Lake Tahoe Region, Volume II Handbook of Management Practices, Tahoe Regional Planning Agency, November 1988.

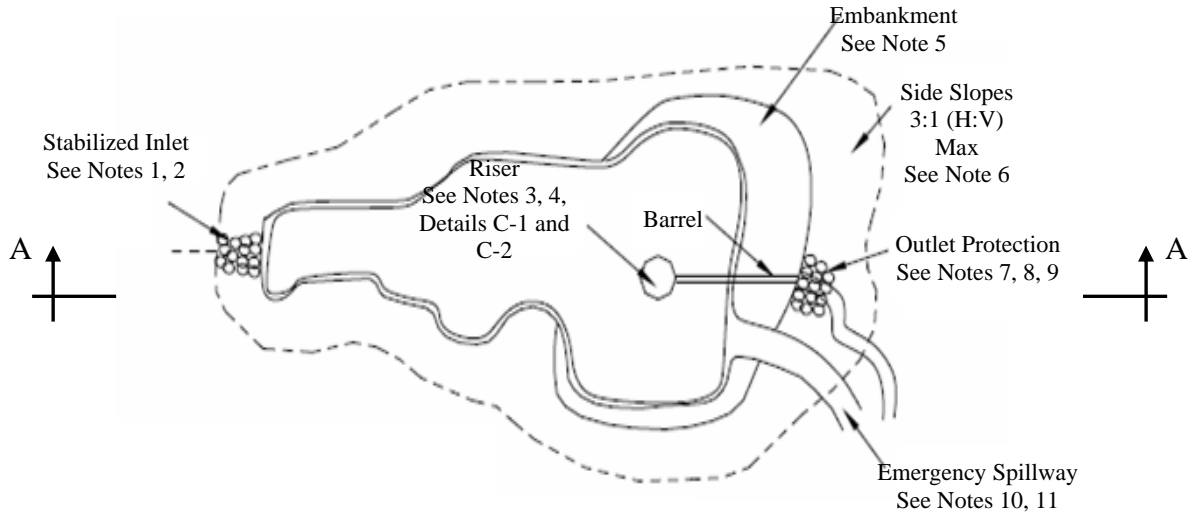

Plan "A"
Top View, Not to Scale

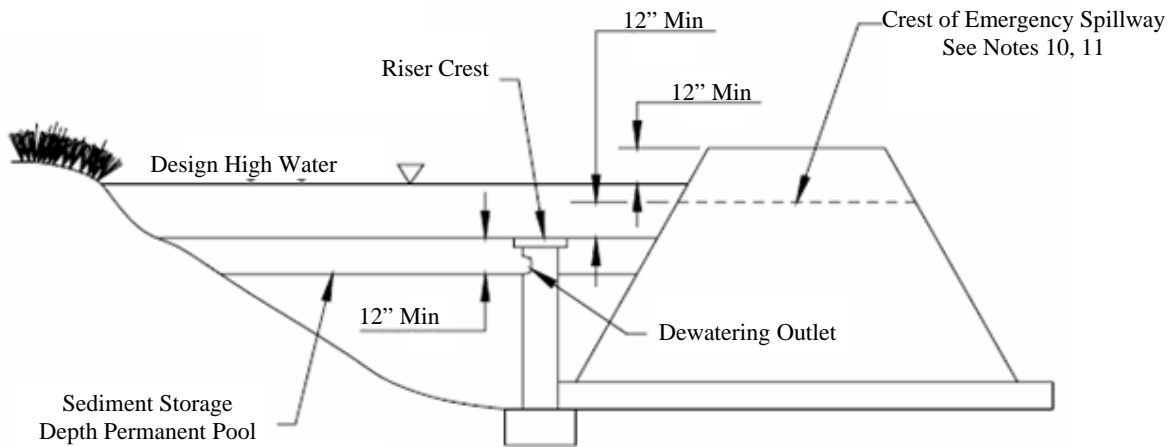

Section A-A
Not to Scale

Temporary Single Orifice Sediment Basin

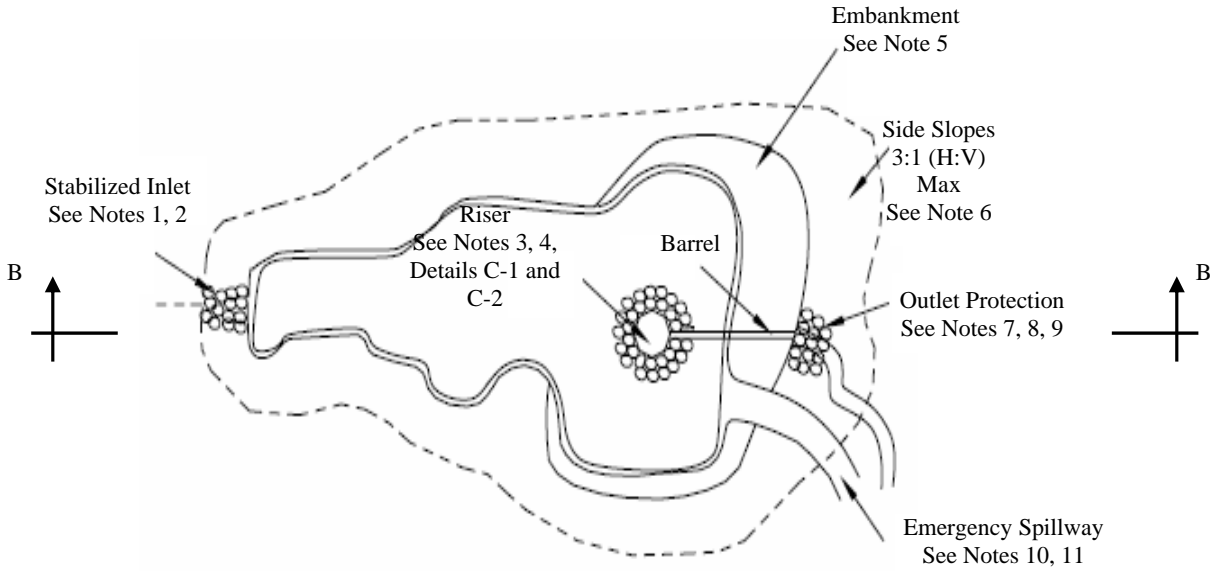

Plan "B"
Top View, Not to Scale

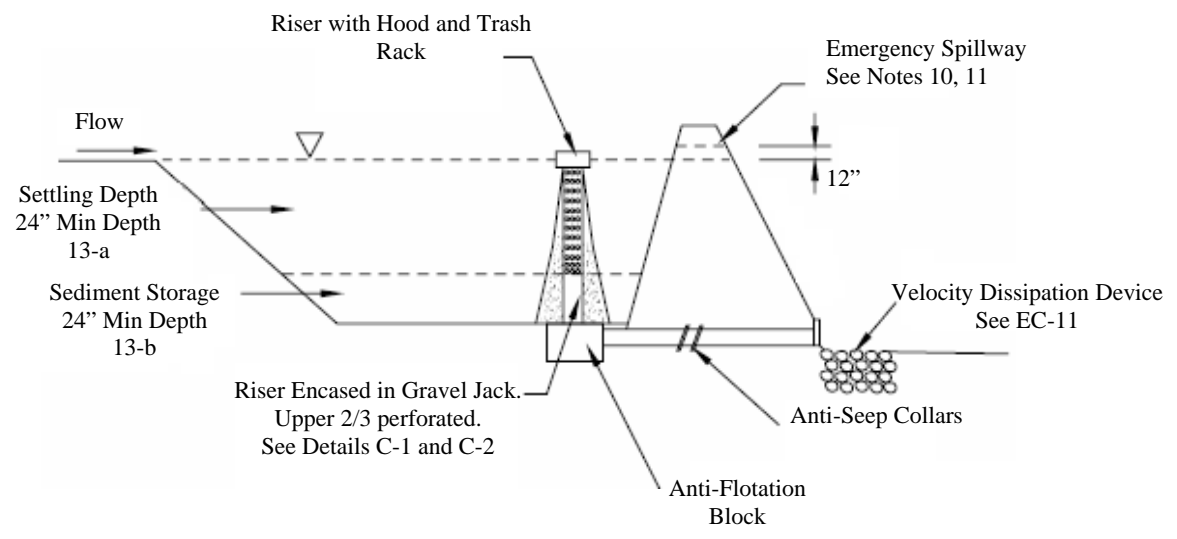

Section B-B
Not to Scale

Temporary Single Orifice Sediment Basin

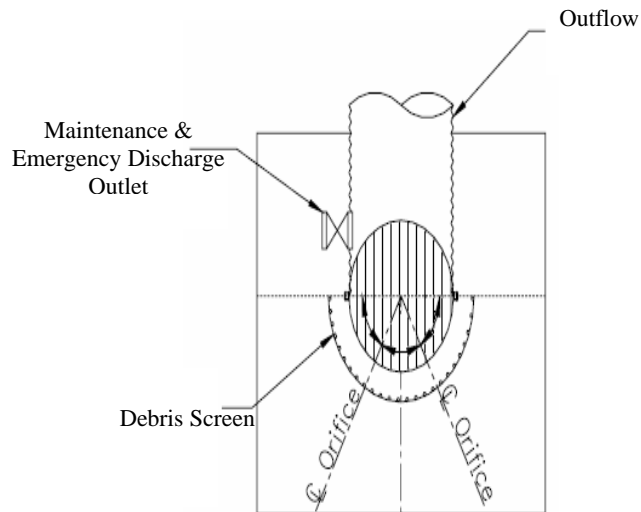

Detail "C-1"
Plan View, Not to Scale

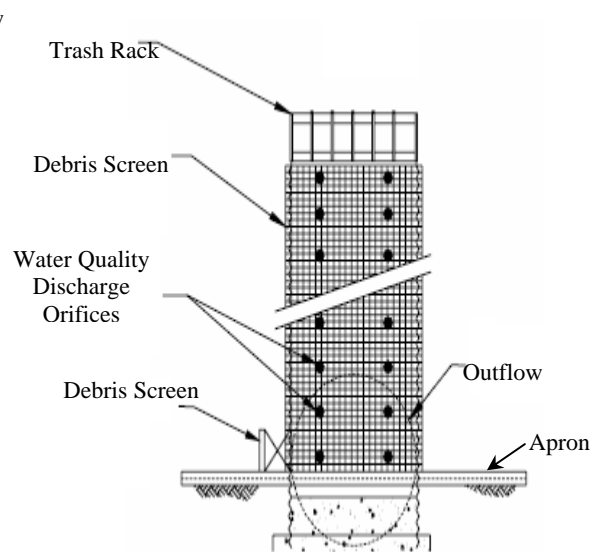

Detail "C-2"
Side View, Not to Scale

Notes:

1. Basin inlets should be located to maximize travel distance to the basin outlet.
2. Rock or vegetation should be used to protect the basin inlet and slopes against erosion.
3. Attach riser pipe (watertight connection) to a horizontal pipe (barrel). Provide anti-seep collars on the barrel.
4. Cleanout level should be clearly marked on the riser pipe.
5. Areas under embankments must be cleared and stripped of vegetation.
6. A maximum side slope of 3:1 (H:V).
7. The outlet shall be sized to achieve the above required detention times. See Rules Relating to Storm Drainage Standards, Jan, 2000. D. of §1-5.1 Part I- Water Quality Criteria).
8. The outlet structure should be placed on a firm, smooth foundation with the base securely anchored with concrete or other means to prevent floatation.
9. The outflow from the sediment basin should be provided with velocity dissipation devices (EC-10) to prevent erosion and scouring of the embankment and channel.
10. The emergency spillway should consist of an open channel (earthen or vegetated) over undisturbed material (not fill) or constructed of a non-erodible riprap.
11. The spillway control section should be a minimum of 20 ft. in length.
12. The depth must be no less than 3 ft.
13. The basin volume consists of two zones:
 - a. A sediment storage zone at least 1 ft. deep.
 - b. A settling zone at least 2 ft. deep.
14. The length to settling depth ratio (L/SD) should be less than 200.
15. A forebay, constructed upstream of the basin may be provided to remove debris and larger particles.
16. Sediment basins that will be used as the only means of treatment, without upstream erosion and sediment controls, must be designed to the satisfaction of CWB NOI Form C.
17. Basins with a height of 25 ft. or more or an impounding capacity of 50 ac-ft or more must obtain approval from State of Hawaii Department of Land and Natural Resources (HAR 13-190 Dams & Reservoirs).
18. Fencing of basin is required.

Multiple Orifice Outlet Riser

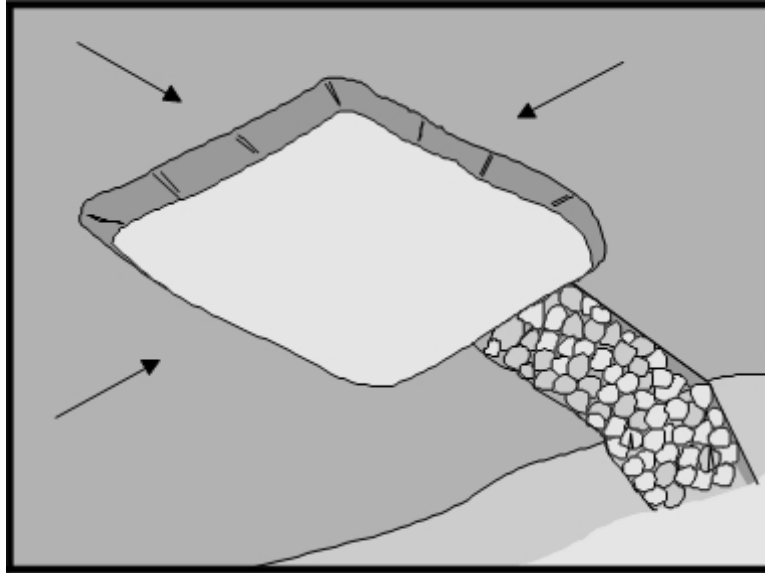

Description and Purpose

A sediment trap is a containment area where sediment-laden runoff is temporarily detained under quiescent conditions, allowing sediment to settle out or before the runoff is discharged. Sediment traps are formed by excavating or constructing an earthen embankment across a waterway or low drainage area.

Suitable Applications

Sediment traps should be considered for use:

- At the downslope project boundary at locations where sediment-laden runoff is discharged offsite;
- At multiple locations within the project site where sediment control is needed;
- Around or upslope from storm drain inlet protection measures;
- Sediment traps may be used on construction projects where the drainage area is less than 5 acres. Traps would be placed where sediment-laden storm water may enter a storm drain or watercourse. SE-2, Sediment Basins, should be used for drainage areas greater than 5 acres; and
- As a supplemental control, sediment traps provide additional protection for a water body or for reducing sediment before it enters a drainage system.

Objectives

- EC – Erosion Control ✓
- SE – Sediment Control
- TR – Tracking Control
- WE – Wind Erosion Control
- NS – Non-Storm Water Management Control
- WM – Waste Management & Materials Pollution Control

Legend:

- ✓ Primary Objective
- ▲ Secondary Objective

Targeted Constituents

- Sediment ✓
- Nutrients
- Trash
- Metals
- Bacteria
- Oil and Grease
- Organics

Potential Alternatives

- SE-2 Sediment Basin (for larger areas)

Limitations

- Requires large surface areas to permit infiltration and settling of sediment.
- Not appropriate for drainage areas greater than 5 acres.
- Only removes large and medium sized particles and requires upstream erosion control.
- Attractive and dangerous to children, requiring protective fencing.
- Conducive to vector production.
- Should not be located in live streams.

Implementation

Design

A sediment trap is a small temporary ponding area, usually with a gravel outlet, formed by excavation or by construction of an earthen embankment. Its purpose is to collect and store sediment from sites cleared or graded during construction. It is intended for use on small drainage areas with no unusual drainage features and projected for a quick build-out time. It should help in removing coarse sediment from runoff. The trap is a temporary measure with a design life of approximately six months to one year and is to be maintained until the site area is permanently protected against erosion by vegetation and/or structures.

Sediment traps should be used only for small drainage areas. If the contributing drainage area is greater than 5 acres, refer to SE-2, Sediment Basins, or subdivide the catchment area into smaller drainage basins.

Sediment usually must be removed from the trap after each rainfall event. The site-specific BMPs plan should detail how this sediment is to be disposed of, such as in fill areas onsite, or removal to an approved offsite dump. Sediment traps used as perimeter controls should be installed before any land disturbance takes place in the drainage area.

Sediment traps are usually small enough that a failure of the structure would not result in a loss of life, damage to home or buildings, or interruption in the use of public roads or utilities. However, sediment traps are attractive to children and can be dangerous. The following recommendations should be implemented to reduce risks:

- Recommend installing continuous fencing around the sediment trap or pond; and
- Restrict basin side slopes to 3:1 or flatter.

Sediment trap size depends on the type of soil, size of the drainage area, and desired sediment removal efficiency (see SE-2, Sediment Basin). As a rule of thumb, the larger the basin volume the greater the sediment removal efficiency. Minimum sizing criteria have been established in the City's "Rules Relating to Soil Erosion Standards and Guidelines." The runoff volume from a 2-year, 24-hour duration storm or 3,600 ft³ of storage per acre drained are common design criteria for a sediment trap. The sizing criteria below assume that this runoff intensity of 1.0 in. While the climatic, topographic, and soil type extremes make it difficult to establish a statewide standard, the following criteria should trap moderate to high amounts of sediment in most areas of Oahu:

- Locate sediment traps as near as practical to areas producing the sediment;
- Trap should be situated according to the following criteria: (1) by excavating a suitable area or where a low embankment can be constructed across a swale, (2) where failure

would not cause loss of life or property damage, and (3) to provide access for maintenance, including sediment removal and sediment stockpiling in a protected area;

- Trap should be sized to accommodate a settling zone and sediment storage zone with recommended minimum volumes of 133 yd³/acre and 66 yd³/acre of contributing drainage area, respectively, based on 1.0 in. of runoff volume over a 24-hour period. In many cases, the size of an individual trap is limited by available space. Multiple traps or additional volume may be required to accommodate specific rainfall, soil, and site conditions;
- Traps with an impounding levee greater than 4.5 ft. tall, measured from the lowest point to the impounding area to the highest point of the levee, and traps capable of impounding more than 35,000 ft³, should be designed by a Licensed Civil Engineer. The design should include maintenance requirements, including sediment and vegetation removal, to ensure continuous function of the trap outlet and bypass structures;
- The outlet pipe or open spillway should be designed to convey anticipated peak flows;
- Use rock or vegetation to protect the trap outlets against erosion; and
- Fencing should be provided to prevent unauthorized entry.

Installation

Sediment traps can be constructed by excavating a depression in the ground or creating an impoundment with a small embankment. Sediment traps should be installed outside the area being graded and should be built prior to the start of the grading activities or removal of vegetation. To minimize the area disturbed by them, sediment traps should be installed in natural depressions or in small swales or drainage ways. The following steps should be followed during installation:

- The area under the embankment must be cleared, grubbed, and stripped of any vegetation and root mat. The pool area should be cleared;
- The fill material for the embankment must be free of roots or other woody vegetation as well as oversized stones, rocks, organic material, or other objectionable material. The embankment may be compacted by traversing with equipment while it is being constructed;
- All cut-and-fill slopes should be 3:1 or flatter;
- When a riser is used, all pipe joints must be watertight;
- When a riser is used, at least the top two-thirds of the riser should be perforated with 0.5 in. diameter holes spaced 8 in. vertically and 10 to 12 in. horizontally. See SE-2, Sediment Basin;
- When an earth or stone outlet is used, the outlet crest elevation should be at least 1 ft. below the top of the embankment; and
- When crushed stone outlet is used, the crushed stone used in the outlet should meet AASHTO M43, size No. 2 or 24, or its equivalent such as MSHA No. 2. Gravel meeting the above gradation may be used if crushed stone is not available.

Costs

Average annual cost per installation and maintenance (18 month useful life) is \$0.73 per ft³ (\$1,300 per drainage acre) in California. Maintenance costs are approximately 20% of installation costs. Note that Hawaii's unit prices are higher than California's unit prices.

Inspection and Maintenance

- Inspect BMPs prior to forecast rain, daily during extended rain events, after rain events, weekly during the rainy season, and at two-week intervals during the non-rainy season.
- Inspect outlet area for erosion and stabilize if required.
- Inspect trap banks for seepage and structural soundness, repair as needed.
- Inspect outlet structure and spillway for any damage or obstructions. Repair damage and remove obstructions as needed.
- Inspect fencing for damage and repair as needed.
- Inspect the sediment trap for area of standing water during every visit. Corrective measures should be taken if the BMP does not dewater completely in 72 hours or less to prevent vector production.
- Sediment that accumulates in the BMP must be periodically removed in order to maintain BMP effectiveness. Sediment should be removed when the sediment accumulation reaches one-third of the trap capacity. Sediment removed during maintenance may be incorporated into earthwork on the site or disposed of at an appropriate location.
- Remove vegetation from the sediment trap when first detected to prevent pools of standing water and subsequent vector production.
- BMPs that require dewatering shall be continuously attended while dewatering takes place. Dewatering BMPs shall be implemented at all times during dewatering activities.

References

Brown, W., and T. Schueler. The Economics of Stormwater BMPs in the Mid-Atlantic Region. Prepared for Chesapeake Research Consortium, Edgewater, MD, by the Center for Watershed Protection, Ellicott City, MD, 1997.

California Stormwater Quality Association (CASQA) Best Management Practices Handbook Construction, 2003.

Draft - Sedimentation and Erosion Control, an Inventory of Current Practices, USEPA, April 1990.

Hawaii Administrative Rules, Title 13, Subtitle 7, Chapter 190, Dams and Reservoirs.

Manual of Standards of Erosion and Sediment Control Measures, Association of Bay Area Governments, May 1995.

Metzger, M.E., D.F. Messer, C.L. Beitia, C.M. Myers, and V.L. Kramer, The Dark Side of Stormwater Runoff Management: Disease Vectors Associated with Structural BMPs, 2002.

National Management Measures to Control Nonpoint Source Pollution from Urban Areas, United States Environmental Protection Agency, 2002.

Proposed Guidance Specifying Management Measures for Sources of Nonpoint Pollution in Coastal Waters, Work Group-Working Paper, USEPA, April 1992.

Stormwater Management Manual for The Puget Sound Basin, Washington State Department of Ecology, Public Review Draft, 1991.

Stormwater Quality Handbooks - Construction Site Best Management Practices (BMPs) Manual, State of California Department of Transportation (Caltrans), November 2000.

U.S. Environmental Protection Agency (USEPA). Guidance Specifying Management Measures for Nonpoint Pollution in Coastal Waters. EPA 840-B-9-002. U.S. Environmental Protection Agency, Office of Water, Washington, DC, 1993.

Water Quality Management Plan for the Lake Tahoe Region, Volume II, Handbook of Management Practices, Tahoe Regional Planning Agency, November 1988.

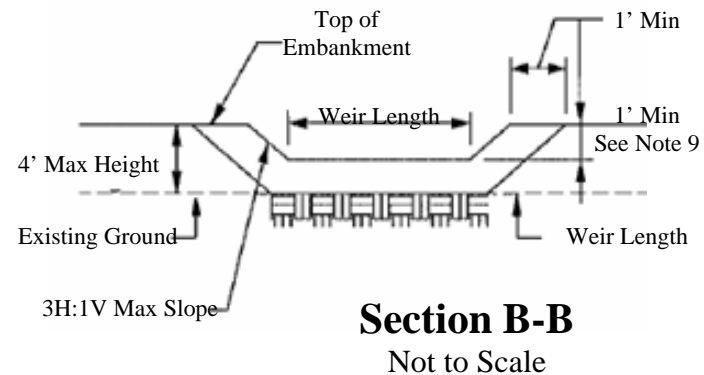
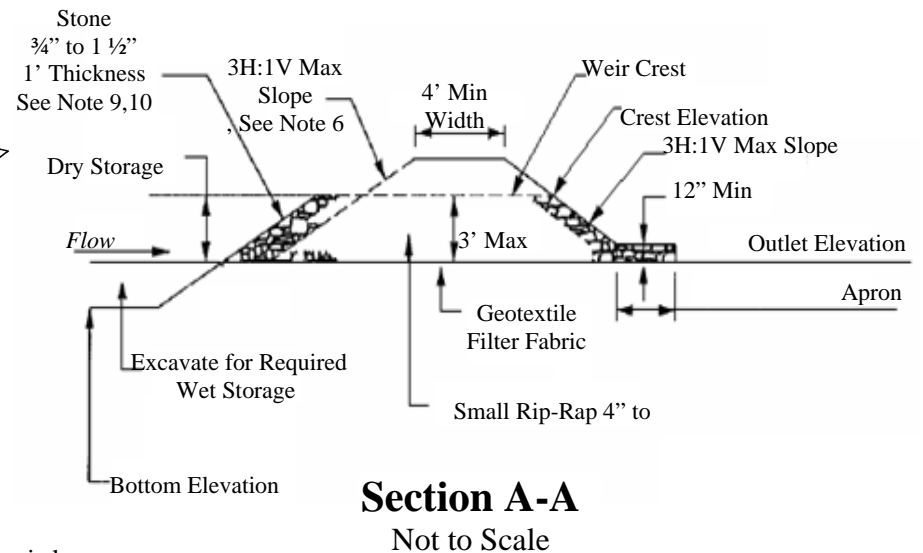
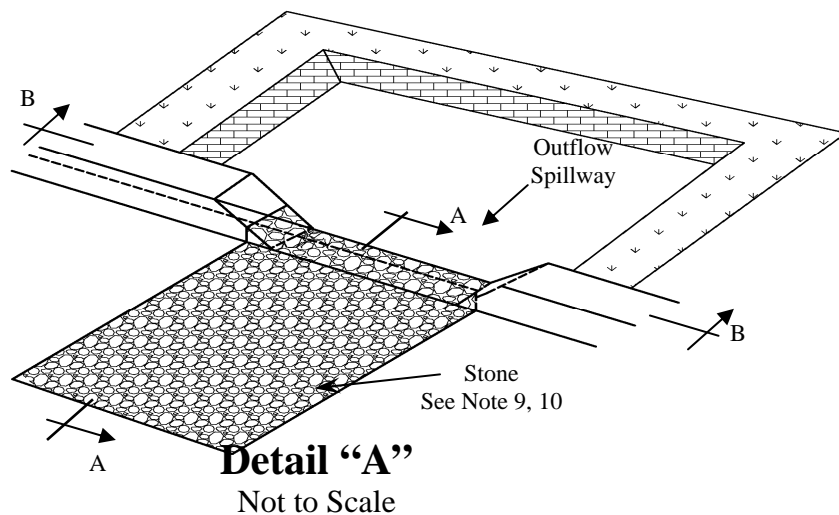

1. Sediment traps may be used on construction projects where the drainage area is less than 5 acres.
2. Trap should be sized to accommodate a settling zone and sediment storage zone with recommended minimum volumes of 133 yd³/acre and 66 yd³/acre of contributing drainage area, respectively, based on 1.0 in. of runoff volume over a 24-hour period.
3. Install continuous fencing around the sediment trap or pond. Consult City ordinances regarding requirements for maintaining health and safety.
4. The area under the embankment must be cleared, grubbed, and stripped of any vegetation and root mat. The pool area should be cleared.
5. The embankment may be compacted by traversing with equipment while it is being constructed.
6. All cut-and-fill slopes should be 3:1 or flatter.
7. When a riser is used, all pipe joints must be watertight.
8. When a riser is used, at least the top two-thirds of the riser should be perforated with 0.5 in. diameter holes spaced 8 in. vertically and 10 to 12 in. horizontally. See SE-2, Sediment Basin.
9. When an earth or stone outlet is used, the outlet crest elevation should be at least 1 ft. below the top of the embankment.
10. When crushed stone outlet is used, the crushed stone used in the outlet should meet AASHTO M43, size No. 2 or 24, or its equivalent such as MSHA No. 2.
11. Traps with an impounding levee greater than 4.5 ft. tall and traps capable of impounding more than 35,000 ft³, should be designed by a Licensed Civil Engineer.

Stone Outlet Sediment Trap

Source: Modified from Maryland Standards and Specifications for Soil Erosion and Sediment Control, 1994

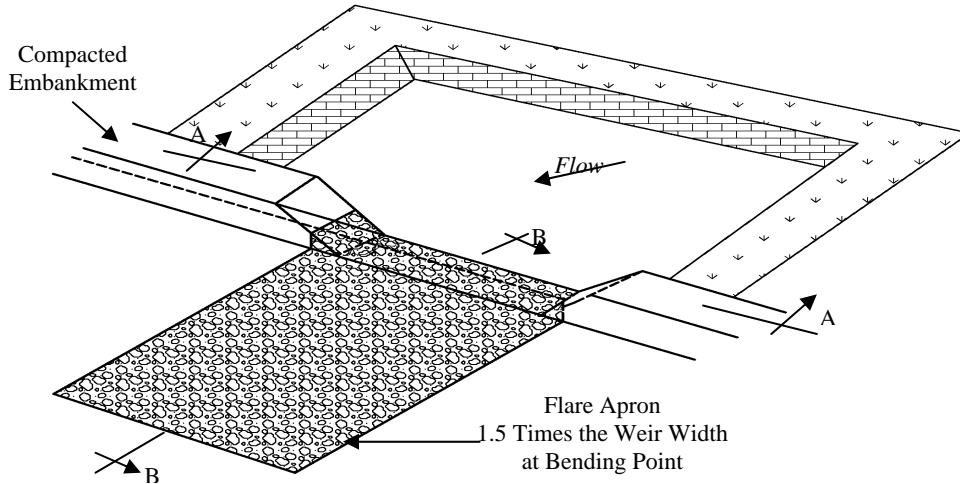

Detail "B"
Not to Scale

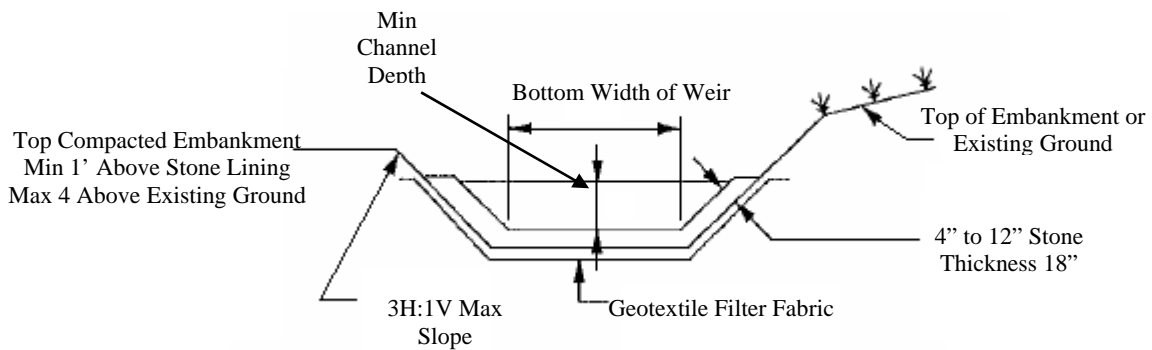

Section A-A
Not to Scale

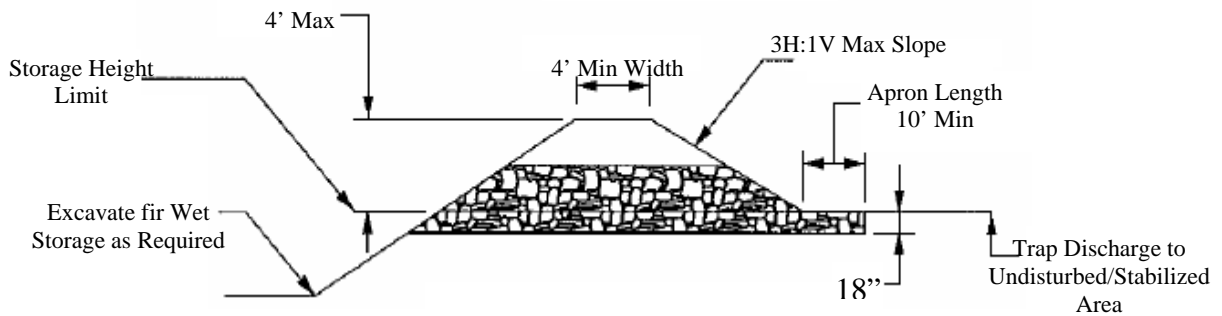

Section B-B
Not to Scale

Rip-Rap Outlet Sediment Trap

Source: Modified from Maryland Standards and Specifications for Soil Erosion and Sediment Control, 1994

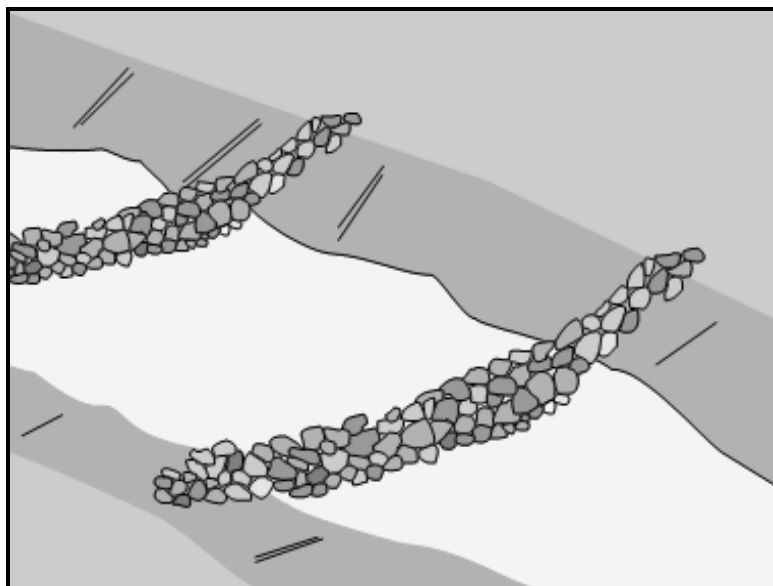

Description and Purpose

A check dam is a small barrier constructed of rock, gravel bags, sandbags, fiber rolls, or reusable products, placed across a constructed swale or drainage ditch. Check dams reduce the effective slope of the channel, thereby reducing the velocity of flowing water, allowing sediment to settle and reducing erosion.

Suitable Applications

Check dams may be appropriate in the following situations:

- To promote sedimentation behind the dam;
- To prevent erosion by reducing the velocity of channel flow in small intermittent channels and temporary swales;
- In small open channels that drain 10 acres or less;
- In steep channels where storm water runoff velocities exceed 5 ft/s;
- During the establishment of grass linings in drainage ditches or channels; and
- In temporary ditches where the short length of service does not warrant establishment of erosion-resistant linings.

Limitations

- Not to be used in live streams or in channels with extended base flows.
- Not appropriate in channels that drain areas greater than 10 acres.

Objectives

EC – Erosion Control	▲
SE – Sediment Control	√
TR – Tracking Control	
WE – Wind Erosion Control	
NS – Non-Storm Water Management Control	
WM – Waste Management & Materials Pollution Control	

Legend:

- √ Primary Objective
- ▲ Secondary Objective

Targeted Constituents

Sediment	√
Nutrients	
Trash	
Metals	
Bacteria	
Oil and Grease	
Organics	

Potential Alternatives

- SE-5 Fiber Rolls
- SE-6 Gravel Bag Berm
- SE-8 Sandbag Barrier

- Not appropriate in channels that are already grass-lined unless erosion is expected, as installation may damage vegetation.
- Require extensive maintenance following high velocity flows.
- Promotes sediment trapping which can be re-suspended during subsequent storms or removal of the check dam.

Implementation

General

Check dams reduce the effective slope and create small pools in swales and ditches that drain 10 acres or less. Reduced slopes reduce the velocity of storm water flows, thus reducing erosion of the swale or ditch and promoting sedimentation. Use of check dams for sedimentation will likely result in little net removal of sediment because of the small detention time and probable scour during longer storms. Using a series of check dams will generally increase their effectiveness. A sediment trap (SE-3) may be placed immediately upstream of the check dam to increase sediment removal efficiency.

Design and Layout

Check dams work by decreasing the effective slope in ditches and swales. An important consequence of the reduced slope is a reduction in capacity of the ditch or swale. This reduction in capacity should be considered when using this BMP, as reduced capacity can result in overtopping of the ditch or swale and resultant consequences. In some cases, such as a “permanent” ditch or swale being constructed early and used as a “temporary” conveyance for construction flows, the ditch or swale may have sufficient capacity such that the temporary reduction in capacity due to check dams is acceptable. When check dams reduce capacities beyond acceptable limits, there are several options:

- Do not use check dams. Consider alternative BMPs; or
- Increase the size of the ditch or swale to restore capacity.

Maximum slope and velocity reduction is achieved when the toe of the upstream dam is at the same elevation as the top of the downstream dam. The center section of the dam should be lower than the edge sections so that the check dam will direct flows to the center of the ditch or swale.

Check dams are usually constructed of rock, gravel bags, sandbags, and fiber rolls. A number of products manufactured specifically for use as check dams are also being used, and some of these products can be removed and reused. Check dams can also be constructed of logs or lumber, and have the advantage of a longer lifespan when compared to gravel bags, sandbags, and fiber rolls. Straw bales can also be used for check dams and can work if correctly installed; but in practice, straw bale check dams have a high failure rate. Check dams should not be constructed from straw bales or silt fences, since concentrated flows quickly wash out these materials.

Rock check dams are usually constructed of 8 to 12 in. rock. The rock is placed either by hand or mechanically, but never just dumped into the channel. The dam must completely span the ditch or swale to prevent washout. The rock used should be large enough to stay in place given the expected design flow through the channel.

Log check dams are usually constructed of 4 to 6 in. diameter logs. The logs should be embedded into the soil at least 18 in. Logs can be bolted or wired to vertical support logs that have been driven or buried into the soil.

Gravel bag and sandbag check dams are constructed by stacking bags across the ditch or swale, shaped as shown in the drawings at the end of this fact sheet.

Manufactured products should be installed in accordance with the manufacturer's instructions.

If grass is planted to stabilize the ditch or swale, the check dam should be removed when the grass has matured (unless the slope of the swales is greater than 4%).

The following guidance should be followed for the design and layout of check dams:

- Install the first check dam approximately 16 ft. from the outfall device and at regular intervals based on slope gradient and soil type;
- Check dams should be placed at a distance and height to allow small pools to form between each check dam;
- Backwater from a downstream check dam should reach the toes of the upstream check dam;
- A sediment trap provided immediately upstream of the check dam will help capture sediment. Due to the potential for this sediment to be resuspended in subsequent storms, the sediment trap must be cleaned following each storm event;
- High flows (typically a 10-year, 1-hour duration storm or larger) should safely flow over the check dam without an increase in upstream flooding or damage to the check dam;
- Where grass is used to line ditches, check dams should be removed when grass has matured sufficiently to protect the ditch or swale; and
- Gravel bags may be used as check dams with the following specifications:

Materials

Gravel bags used for check dams should conform to the requirements of SE-6, Gravel Bag Berms. Sandbags used for check dams should conform to SE-8, Sandbag Barrier.

Installation

- Rock should be placed individually by hand or by mechanical methods (no dumping of rock) to achieve complete ditch or swale coverage.
- Tightly abut bags and stack according to detail shown in the figure at the end of this section. Gravel bags and sandbags should not be stacked any higher than 3 ft.
- Fiber rolls should be trenched in and firmly staked in place.

Costs

Cost consists of only installation costs if materials are readily available. If material must be imported, costs may increase. For material costs, see SE-5, SE-6, and SE-8.

Inspection and Maintenance

- Inspect BMPs prior to forecast rain, daily during extended rain events, after rain events, weekly during the rainy season, and at two-week intervals during the non-rainy season.
- Replace missing rock, bags, etc. Replace bags that have degraded or have become damaged.
- If the check dam is used as a sediment capture device, sediment that accumulates in the BMP must be periodically removed in order to maintain BMP effectiveness. Sediment should be removed when the sediment accumulation reaches one-third of the barrier height. Sediment removed during maintenance may be incorporated into earthwork on the site or disposed at an appropriate location.
- If the check dam is used as a grade control structure, sediment removal is not required as long as the system continues to control the grade.
- Remove accumulated sediment prior to permanent seeding or soil stabilization.
- Remove check dam and accumulated sediment when check dams are no longer needed.

References

California Stormwater Quality Association (CASQA) Best Management Practices Handbook Construction, 2003.

Draft - Sedimentation and Erosion Control, and Inventory of Current Practices, USEPA, April 1990.

Manual of Standards of Erosion and Sediment Control Measures, Association of Bay Area Governments, May 1995.

Stormwater Management of the Puget Sound Basin, Technical Manual, Publication #91-75, Washington State Department of Ecology, February 1992.

Stormwater Quality Handbooks - Construction Site Best Management Practices (BMPs) Manual, State of California Department of Transportation (Caltrans), November 2000.

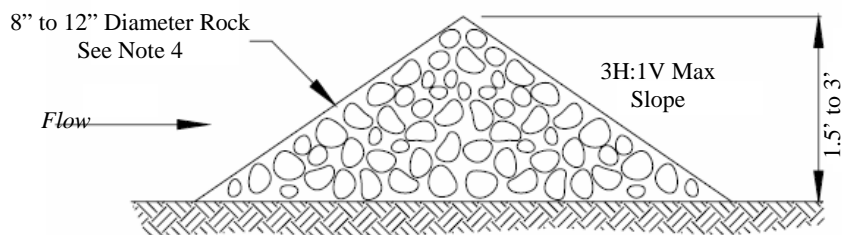

Type "A" Rock Check Dam

Not to Scale

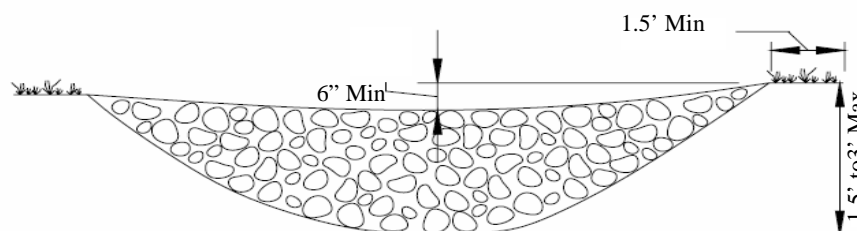

Type "B" Rock Check Dam

Not to Scale

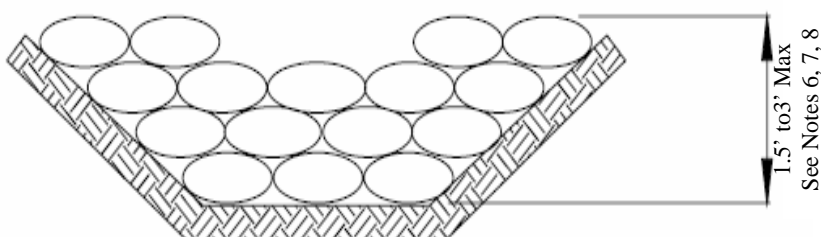

Gravel Bag Check Dam Elevation

Not to Scale

Notes:

1. Install the first check dam approximately 16 ft. from the outfall device and at regular intervals based on slope gradient and soil type.
2. Check dams may be used in small open channels that drain 10 acres or less.
3. Check dams may be used in steep channels where storm water runoff velocities exceed 5 ft/s.
4. Rock check dams are usually constructed of 8 to 12 in. rock. The rock is placed either by hand or mechanically, but never just dumped into the channel.
5. Log check dams are usually constructed of 4 to 6 in. diameter logs. The logs should be embedded into the soil at least 18 in. Logs can be bolted or wired to vertical support logs that have been driven or buried into the soil.
6. Gravel bags and sandbags should not be stacked any higher than 3 ft.
7. Tightly abut bags.
8. Gravel bags used should conform to the requirements of SE-6. Sandbags used should conform to SE-8.
9. Fiber rolls should be trenched in and firmly staked in place.
10. Manufactured products should be installed in accordance with the manufacturer's instructions. For Design and Layout see SE-4 Check Dams.

Check Dams

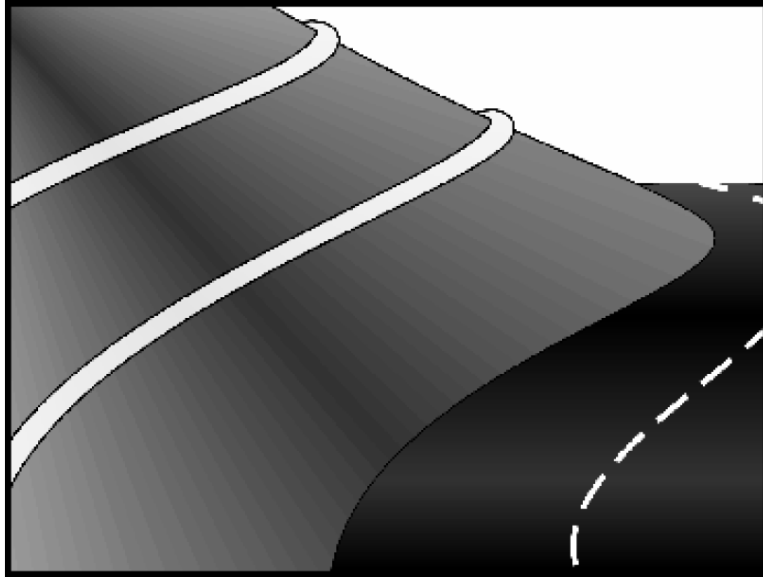

Description and Purpose

A fiber roll consists of straw, flax, mulch, or other similar materials bound into a tight tubular roll. When fiber rolls are placed at the toe and on the face of slopes, they intercept runoff, reduce its flow velocity, release the runoff as sheet flow, and provide removal of sediment from the runoff. By interrupting the length of a slope, fiber rolls can also reduce erosion.

Suitable Applications

Fiber rolls may be suitable:

- Along the toe, top, face, and at grade breaks of exposed and erodible slopes to shorten slope length and spread runoff as sheet flow;
- At the end of a downward slope where it transitions to a steeper slope;
- Along the perimeter of a project;
- As check dams in unlined ditches;
- Down-slope of exposed soil areas; and/or
- Around temporary stockpiles.

Limitations

- Fiber rolls are not effective unless trenched.
- Fiber rolls at the toe of slopes greater than 5:1 (H:V) should be a minimum of 20 in. diameter or installations achieving the same protection (i.e. stacked smaller diameter fiber rolls, etc.).
- Difficult to move once saturated.

Objectives

- EC – Erosion Control ▲
- SE – Sediment Control ✓
- TR – Tracking Control
- WE – Wind Erosion Control
- NS – Non-Storm Water Management Control
- WM – Waste Management & Materials Pollution Control

Legend:

- ✓ Primary Objective
- ▲ Secondary Objective

Targeted Constituents

- Sediment ✓
- Nutrients
- Trash
- Metals
- Bacteria
- Oil and Grease
- Organics

Potential Alternatives

- SE-1 Silt Fence
- SE-6 Gravel Bag Berm
- SE-8 Sandbag Barrier

- If not properly staked and trenched in, fiber rolls could be transported by high flows.
- Fiber rolls have a very limited sediment capture zone.
- Fiber rolls should not be used on slopes subject to creep, slumping, or landslide.

Implementation

Fiber Roll Materials

- Fiber rolls should be either prefabricated rolls or rolled tubes of erosion control blanket.

Assembly of Field Rolled Fiber Roll

- Roll length of erosion control blanket into a tube of minimum 8 in. diameter.
- Bind roll at each end and every 4 ft. along length of roll with jute-type twine.

Installation

- Locate fiber rolls on level contours spaced as follows:
 - Slope inclination of 4:1 (H:V) or flatter: Fiber rolls should be placed at a maximum interval of 20 ft.;
 - Slope inclination between 4:1 and 2:1 (H:V): Fiber Rolls should be placed at a maximum interval of 15 ft. (a closer spacing is more effective); and
 - Slope inclination 2:1 (H:V) or greater: Fiber Rolls should be placed at a maximum interval of 10 ft. (a closer spacing is more effective).
- Turn the ends of the fiber roll up slope to prevent runoff from going around the roll.
- Stake fiber rolls into a 2 to 4 in. deep trench with a width equal to the diameter of the fiber roll.
 - Drive stakes at the end of each fiber roll and spaced 4 ft. maximum on center.
 - Use stakes with a minimum length of 24 in.
- If more than one fiber roll is placed in a row, the rolls should be overlapped, not abutted.

Removal

- Fiber rolls are typically left in place.
- If fiber rolls are removed, collect and dispose of sediment accumulation, and fill and compact holes, trenches, depressions or any other ground disturbance to blend with adjacent ground.

Costs

Material costs for fiber rolls range from \$20 - \$30 per 25 ft. roll in California. Note that Hawaii's unit prices are higher than California's unit prices.

Inspection and Maintenance

- Inspect BMPs prior to forecast rain, daily during extended rain events, after rain events, weekly during the rainy season, and at two-week intervals during the non-rainy season.
- Repair or replace split, torn, unraveling, or slumping fiber rolls.
- If the fiber roll is used as a sediment capture device, or as an erosion control device to maintain sheet flows, sediment that accumulates in the BMP must be periodically

removed in order to maintain BMP effectiveness. Sediment should be removed when sediment accumulation reaches one-half the designated sediment storage depth, usually one-half the distance between the top of the fiber roll and the adjacent ground surface. Sediment removed during maintenance may be incorporated into earthwork on the site of disposal at an appropriate location.

- If fiber rolls are used for erosion control, such as in a mini check dam, sediment removal should not be required as long as the system continues to control the grade. Sediment control BMPs will likely be required in conjunction with this type of application.

References

California Stormwater Quality Association (CASQA) Best Management Practices Handbook Construction, 2003.

Stormwater Quality Handbooks - Construction Site Best Management Practices (BMPs) Manual, State of California Department of Transportation (Caltrans), November 2000.

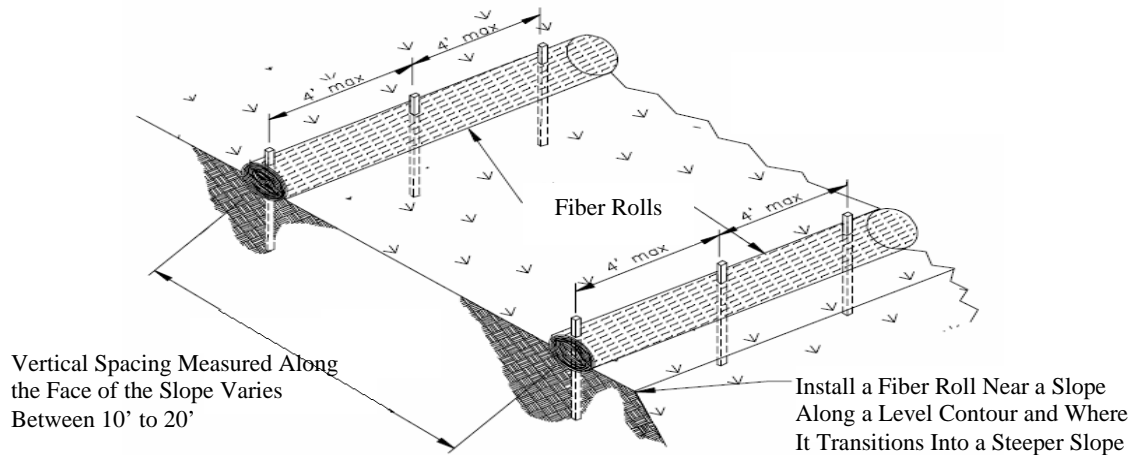

Detail "A"
Not to Scale

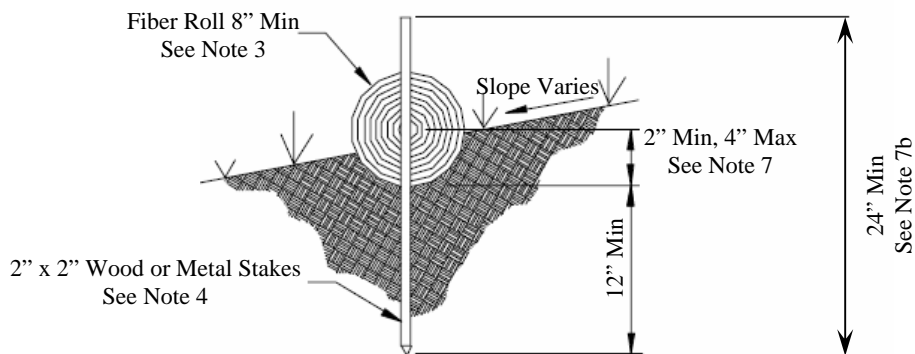

Section A-A
Not to Scale

Notes:

1. Fiber rolls at the toe of slopes greater than 5:1 (H:V) should be a minimum of 20 in. diameter or installations achieving the same protection.
2. Fiber rolls should be either prefabricated rolls or rolled tubes of erosion control blanket.
3. Roll length of erosion control blanket into a tube of minimum 8 in. diameter.
4. Bind roll at each end and every 4 ft. along length of roll with jute-type twine.
5. Locate fiber rolls on level contours spaced as follows:
 - a. Slope inclination of 4:1 (H:V) or flatter: Fiber rolls should be placed at a maximum interval of 20 ft.
 - b. Slope inclination between 4:1 and 2:1 (H:V): Fiber Rolls should be placed at a maximum interval of 15 ft. (a closer spacing is more effective).
 - c. Slope inclination 2:1 (H:V) or greater: Fiber Rolls should be placed at a maximum interval of 10 ft. (a closer spacing is more effective).
6. Turn the ends of the fiber roll up slope to prevent runoff from going around the roll.
7. Stake fiber rolls into a 2 to 4 in. deep trench with a width equal to the diameter of the fiber roll.
 - a. Drive stakes at the end of each fiber roll and spaced 4 ft. maximum on center.
 - b. Use stakes with a minimum length of 24 in.
8. If more than one fiber roll is placed in a row, the rolls should be overlapped, not abutted.

Fiber Rolls

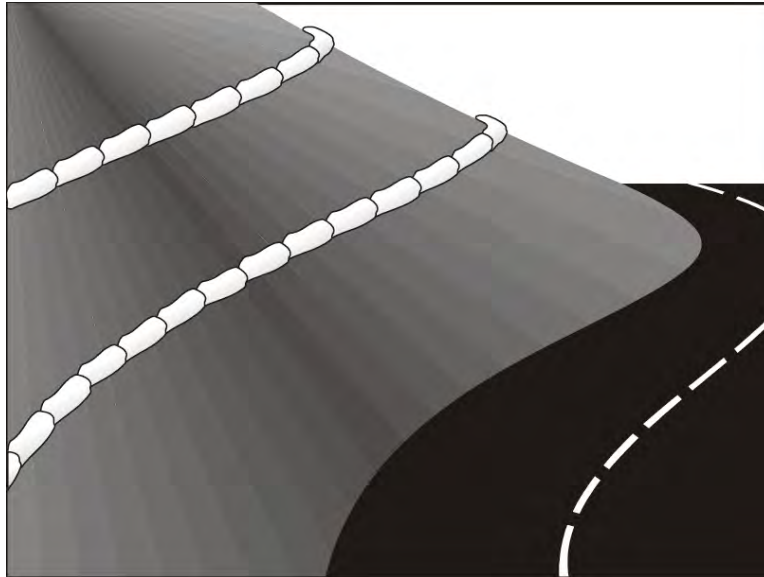

Description and Purpose

A gravel bag berm is a series of gravel-filled bags placed on a level contour to intercept sheet flows. Gravel bags pond sheet flow runoff, allowing sediment to settle out, and release runoff slowly as sheet flows, preventing erosion.

Suitable Applications

Gravel bag berms may be suitable:

- As a linear sediment control measure:
 - Below the toe of slopes and erodible slopes;
 - As sediment traps at culvert/pipe outlets;
 - Below other small cleared areas;
 - Along the perimeter of a site;
 - Down slope of exposed soil areas;
 - Around temporary stockpiles and spoil areas;
 - Parallel to a roadway to keep sediment off paved areas; or
 - Along streams and channels.
- As linear erosion control measure:
 - Along the face and at grade breaks of exposed and erodible slopes to shorten slope length and spread runoff as sheet flow;
 - At the top of slopes to divert runoff away from disturbed slopes; or
 - As check dams across mildly sloped construction roads.

Objectives

EC – Erosion Control	▲
SE – Sediment Control	√
TR – Tracking Control	
WE – Wind Erosion Control	
NS – Non-Storm Water Management Control	
WM – Waste Management & Materials Pollution Control	

Legend:

- √ Primary Objective
- ▲ Secondary Objective

Targeted Constituents

Sediment	√
Nutrients	
Trash	
Metals	
Bacteria	
Oil and Grease	
Organics	

Potential Alternatives

- SE-1 Silt Fence
- SE-5 Fiber Rolls
- SE-8 Sandbag Barrier

Limitations

- Gravel berms may be difficult to remove.
- Removal problems limit their usefulness in landscaped areas.
- Gravel bag berm may not be appropriate for drainage areas greater than 5 acres.
- Runoff will pond upstream of the filter, possibly causing flooding if sufficient space does not exist.
- Degraded gravel bags may rupture when removed, spilling contents.
- Installation can be labor intensive.
- Berms may have limited durability for long-term projects.
- When used to detain concentrated flows, maintenance requirements increase.

Implementation

General

A gravel bag berm consists of a row of open graded gravel-filled bags placed on a level contour. When appropriately placed, a gravel bag berm intercepts and slows sheet flow runoff, causing temporary ponding. The temporary ponding provides quiescent conditions allowing sediment to settle. The open graded gravel in the bags is porous, which allows the ponded runoff to flow slowly through the bags, releasing the runoff as sheet flows. Gravel bag berms also interrupt the slope length and thereby reduce erosion by reducing the tendency of sheet flows to concentrate into rivulets, which erode rills, and ultimately gullies, into disturbed, sloped soils. Gravel bag berms are similar to sand bag barriers, but are more porous.

Design and Layout

- Locate gravel bag berms on level contours.
 - Slopes between 20:1 and 2:1 (H:V): Gravel bags should be placed at a maximum interval of 50 ft. (a closer spacing is more effective), with the first row near the slope toe.
 - Slopes 2:1 (H:V) or steeper: Gravel bags should be placed at a maximum interval of 25 ft. (a closer spacing is more effective), with the first row placed the slope toe.
- Turn the ends of the gravel bag barriers up slope to prevent runoff from going around the berm.
- Allow sufficient space up slope from the gravel bag berm to allow ponding, and to provide room for sediment storage.
- For installation near the toe of the slope, consider moving the gravel bag barriers away from the slope toe to facilitate cleaning. To prevent flows behind the barrier, bags can be placed perpendicular to a berm to serve as cross barriers.
- Drainage area should not exceed 5 acres.
- In Non-Traffic Areas:
 - Height = 18 in. maximum,
 - Top width = 24 in. minimum for three or more layer construction,
 - Top width = 12 in. minimum for one or two layer construction, and
 - Side slopes = 2:1 or flatter.

- In Construction Traffic Areas:
 - Height = 12 in. maximum,
 - Top width = 24 in. minimum for three or more layer construction,
 - Top width = 12 in. minimum for one or two layer construction, and
 - Side slopes = 2:1 or flatter.
- Butt ends of bags tightly.
- On multiple row, or multiple layer construction, overlap butt joints of adjacent row and row beneath.
- Use a pyramid approach when stacking bags.

Materials

- **Bag Material:** Bags should be woven polypropylene, polyethylene or polyamide fabric or burlap, minimum unit weight of 4 ounces/yd², Mullen burst strength exceeding 300 lb/in² in conformance with the requirements in ASTM designation D3786, and ultraviolet stability exceeding 70% in conformance with the requirements in ASTM designation D4355.
- **Bag Size:** Each gravel-filled bag should have a length of 18 in., width of 12 in., thickness of 3 in., and mass of approximately 33 lbs. Bag dimensions are nominal, and may vary based on locally available materials.
- **Fill Material:** Fill material should be 0.5 to 1 in. Class 2 aggregate base, clean and free from clay, organic matter, and other deleterious material, or other suitable open graded, non-cohesive, porous gravel.

Costs

Gravel filter: Expensive, since off-site materials, hand construction, and demolition/removal are usually required. Material costs for gravel bags are average of \$2.50 per empty gravel bag.

Gravel costs range from \$20-\$35 per yd³ in California. Note that Hawaii's unit prices are higher than California's unit prices.

Inspection and Maintenance

- Inspect BMPs prior to forecast rain, daily during extended rain events, after rain events, weekly during the rainy season, and at two-week intervals during the non-rainy season.
- Gravel bags exposed to sunlight will need to be replaced every two to three months due to degrading of the bags.
- Reshape or replace gravel bags as needed.
- Repair washouts or other damage as needed.
- Sediment that accumulates in the BMP must be periodically removed in order to maintain BMP effectiveness. Sediment should be removed when the sediment accumulation reaches one-third of the barrier height. Sediment removed during maintenance may be incorporated into earthwork on the site or disposed at an appropriate location.
- Remove gravel bag berms when no longer needed. Remove sediment accumulation and clean, re-grade, and stabilize the area. Removed sediment should be incorporated in the project or disposed of.

References

California Stormwater Quality Association (CASQA) Best Management Practices Handbook Construction, 2003.

Handbook of Steel Drainage and Highway Construction, American Iron and Steel Institute, 1983.

Stormwater Pollution Plan Handbook, First Edition, State of California, Department of Transportation Division of New Technology, Materials and Research, October 1992.

Stormwater Quality Handbooks - Construction Site Best Management Practices (BMPs) Manual, State of California Department of Transportation (Caltrans), November 2000.



Description and Purpose

Street sweeping, washing and vacuuming includes use of self-propelled and walk-behind equipment to remove sediment from streets and roadways, and to clean paved surfaces in preparation for final paving. Sweeping and vacuuming prevents sediment from the project site from entering storm drains or receiving waters.

Suitable Applications

Sweeping, washing and vacuuming are suitable anywhere sediment is tracked from the project site onto public or private paved streets and roads, typically at points of egress. Sweeping and vacuuming are also applicable during preparation of paved surfaces for final paving.

Limitations

Sweeping and vacuuming may not be effective when sediment is wet or when tracked soil is caked (caked soil may need to be scraped loose).

Implementation

- Controlling the number of points where vehicles can leave the site will allow sweeping and vacuuming efforts to be focused, and perhaps save money.
- Inspect potential sediment tracking locations daily.
- Visible sediment tracking should be swept or vacuumed on a daily basis.
- Do not use kick brooms or sweeper attachments. These tend to spread the dirt rather than remove it.

Objectives

- EC – Erosion Control
- SE – Sediment Control ▲
- TR – Tracking Control ✓
- WE – Wind Erosion Control
- NS – Non-Storm Water Management Control
- WM – Waste Management & Materials Pollution Control

Legend:

- ✓ Primary Objective
- ▲ Secondary Objective

Targeted Constituents

- Sediment ✓
- Nutrients
- Trash ✓
- Metals
- Bacteria
- Oil and Grease ✓
- Organics

Potential Alternatives

None

- If not mixed with debris or trash, consider incorporating the removed sediment back into the project

NPDES Permit Background

NPDES Permit No. HI S000002 issued by the State Department of Health (DOH) to the City and County of Honolulu for its municipal separate storm sewer system provides in pertinent part as follows:

“The following non-storm water discharges may be discharged into the Permittee’s separate storm sewer system without an NPDES permit, provided that the Permittee determines that such discharges will not contain pollutants in amounts that will cause or contribute to a violation of an applicable water quality standard and the SWMP [Storm Water Management Plan] shall identify and ensure the implementation of appropriate pollution prevention measures for the non-storm water component(s) of the discharge.”

“Residual street wash water (water only), including wash water from sidewalks, plazas, and driveways, but excluding parking lots.”

“The discharge of pollutants from the Permittee’s MS4 [Municipal Separate Storm Sewer Systems] and Small MS4 facilities shall be reduced to the Maximum Extent Practicable (MEP).”

Handling Procedure

The Department of Environmental Services (ENV) acknowledges that it may be necessary to wash streets to control dust, sediment, and other pollutants during construction. However, the discharger should use appropriate BMPs and be responsible for complying with the City, State and Federal rules and regulations. Other related BMPs include graveled entrances and, if necessary, tire washing.

The following handling procedures are listed for guidance purposes only where they are deemed applicable:

- The street should be swept (or alternative dry cleanup methods) before any washing takes place. Alternatively, washing may occur in the uphill direction and immediately followed by a vacuum truck;
- Drain inlet should be protected with a “Gutter Buddy,” “True Dam,” or other drain inlet protection device, or water should be directed away from drain inlets; and
- No chemicals or solvents may be used during washing.

For more information, please call the Storm Water Quality Branch of ENV at (808) 768-3242.

Costs

Rental rates for self-propelled sweepers vary depending on hopper size and duration of rental.

Expect rental rates from \$58/hour (3 yd³ hopper) to \$88/hour (9 yd³ hopper), plus operator costs in California. Hourly production rates vary with the amount of area to be swept and amount of sediment. Match the hopper size to the area and expect sediment load to minimize time spent dumping. Note that Hawaii’s unit prices are higher than California’s unit prices.

Inspection and Maintenance

- Inspect BMPs prior to forecast rain, daily during extended rain events, after rain events, weekly during the rainy season, and at two-week intervals during the non-rainy season.
- When actively in use, points of ingress and egress must be inspected daily.
- When tracked or spilled sediment is observed outside the construction limits, it must be removed at least daily. More frequent removal, even continuous removal, may be required in some jurisdictions.
- Be careful not to sweep up any unknown substance or any object that may be potentially hazardous.
- Adjust brooms frequently; maximize efficiency of sweeping operations.
- After sweeping is finished, properly dispose of sweeper wastes at an approved dumpsite.

References

California Stormwater Quality Association (CASQA) Best Management Practices Handbook Construction, 2003.

Labor Surcharge and Equipment Rental Rates, State of California Department of Transportation (Caltrans), April 1, 2002 – March 31, 2003.

State of Hawaii Department of Health Clean Water Branch NPDES Permit HIS000002 for City & County of Honolulu.

Stormwater Quality Handbooks - Construction Site Best Management Practices (BMPs) Manual, State of California Department of Transportation (Caltrans), November 2000.

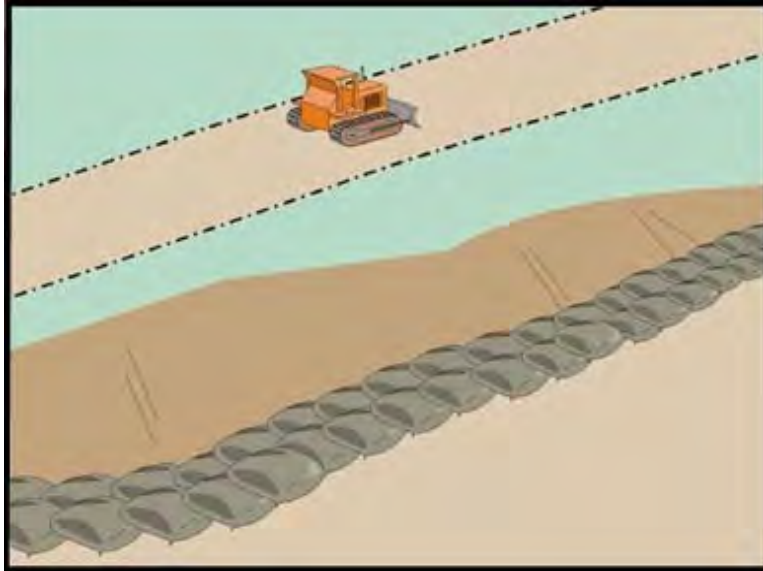

Description and Purpose

A sandbag barrier is a series of sand-filled bags placed on a level contour to intercept sheet flows. Sandbag barriers pond sheet flow runoff, allowing sediment to settle out.

Suitable Applications

Sandbag barriers may be suitable:

- As a linear sediment control measure:
 - Below the toe of slopes and erodible slopes;
 - As sediment traps at culvert/pipe outlets;
 - Below other small cleared areas;
 - Along the perimeter of a site;
 - Down slope of exposed soil areas;
 - Around temporary stockpiles and spoil areas;
 - Parallel to a roadway to keep sediment off paved areas; or
 - Along streams and channels.
- As linear erosion control measure:
 - Along the face and at grade breaks of exposed and erodible slopes to shorten slope length and spread runoff as sheet flow;
 - At the top of slopes to divert runoff away from disturbed slopes; or
 - As check dams across mildly sloped construction roads.

Objectives

EC – Erosion Control	▲
SE – Sediment Control	√
TR – Tracking Control	
WE – Wind Erosion Control	
NS – Non-Storm Water Management Control	
WM – Waste Management & Materials Pollution Control	

Legend:

- √ Primary Objective
- ▲ Secondary Objective

Targeted Constituents

Sediment	√
Nutrients	
Trash	
Metals	
Bacteria	
Oil and Grease	
Organics	

Potential Alternatives

- SE-1 Silt Fence
- SE-5 Fiber Rolls
- SE-6 Gravel Bag Berm

Limitations

- It is necessary to limit the drainage area upstream of the barrier to 5 acres.
- Degraded sandbags may rupture when removed, spilling sand.
- Installation can be labor intensive.
- Barriers may have limited durability for long-term projects.
- When used to detain concentrated flows, maintenance requirements increase.
- Burlap should not be used for sandbags.

Implementation

General

A sandbag barrier consists of a row of sand-filled bags placed on a level contour. When appropriately placed, a sandbag barrier intercepts and slows sheet flow runoff, causing temporary ponding. The temporary ponding provides quiescent conditions allowing sediment to settle. While the sand-filled bags are porous, the fine sand tends to quickly plug with sediment, limiting the rate of flow through the barrier. If a porous barrier is desired, consider SE-1, Silt Fence, SE-5, Fiber Rolls, or SE-6, Gravel Bag Berms. Sandbag barriers also interrupt the slope length and thereby reduce erosion by reducing the tendency of sheet flows to concentrate into rivulets which erode rills, and ultimately gullies, into disturbed, sloped soils. Sandbag barriers are similar to ground bag berms, but less porous.

Design and Layout

- Locate sandbag barriers on a level contour.
 - Slopes between 20:1 and 2:1 (H:V): Sandbags should be placed at a maximum interval of 50 ft. (a closer spacing is more effective), with the first row near the slope toe.
 - Slopes 2:1 (H:V) or steeper: Sandbags should be placed at a maximum interval of 25 ft. (a closer spacing is more effective), with the first row placed near the slope toe.
- Turn the ends of the sandbag barrier up slope to prevent runoff from going around the barrier.
- Allow sufficient space up slope from the barrier to allow ponding, and to provide room for sediment storage.
- For installation near the toe of the slope, consider moving the barrier away from the slope toe to facilitate cleaning. To prevent flow behind the barrier, sandbags can be placed perpendicular to the barrier to serve as cross barriers.
- Drainage area should not exceed 5 acres.
- Stack sandbags at least three bags high with proper side slopes.
- Butt ends of bags tightly.
- Overlap butt joints of row beneath with each successive row.
- Use a pyramid approach when stacking bags.

- In non-traffic areas:
 - Height = 12 in. maximum,
 - Top width = 12 in. minimum for three or more layer construction, and
 - Side slope = 2:1 or flatter.
- In construction traffic areas:
 - Height = 12 in. maximum,
 - Top width = 24 in. minimum for three or more layer construction, and
 - Side slopes = 2:1 or flatter.

Materials

- **Sandbag Material:** Sandbag should be woven polypropylene, polyethylene or polyamide fabric, minimum unit weight of 4 ounces/yd², Mullen burst strength exceeding 300 lb/in² in conformance with the requirements in ASTM designation D3786, and ultraviolet stability exceeding 70% in conformance with the requirements in ASTM designation D4355. Use of burlap may not be acceptable in some jurisdictions.
- **Sandbag Size:** Each sand-filled bag should have a length of 18 in., width of 12 in., thickness of 3 in., and mass of approximately 33 lbs. Bag dimensions are nominal, and may vary based on locally available materials.
- **Fill Material:** All sandbag fill material should be non-cohesive soil permeable material free from clay and deleterious material.

Costs

Sandbag barriers are more costly, but typically have a longer useful life than other barriers. Empty sandbags cost \$0.25 - \$0.75. Average cost of fill material is \$8 per yd³. Pre-filled sandbags are more expensive at \$1.50 - \$2.00 per bag in California. Note that Hawaii's unit prices are higher than California's unit prices.

Inspection and Maintenance

- Inspect BMPs prior to forecast rain, daily during extended rain events, after rain events, weekly during the rainy season, and at two-week intervals during the non-rainy season.
- Sandbags exposed to sunlight will need to be replaced every two to three months due to degradation of the bags.
- Reshape or replace sandbags as needed.
- Repair washouts or other damage as needed.
- Sediment that accumulates in the BMP must be periodically removed in order to maintain BMP effectiveness. Sediment should be removed when the sediment accumulation reaches one-third of the barrier height. Sediment removed during maintenance may be incorporated into earthwork on the site or disposed at an appropriate location.
- Remove sandbags when no longer needed. Remove sediment accumulation, and clean, re-grade, and stabilize the area.

References

California Stormwater Quality Association (CASQA) Best Management Practices Handbook Construction, 2003.

Stormwater Quality Handbooks - Construction Site Best Management Practices (BMPs) Manual, State of California Department of Transportation (Caltrans), November 2000.

The Disaster Handbook 1998 National Edition, Institute of Food and Agricultural Sciences, University of Florida.

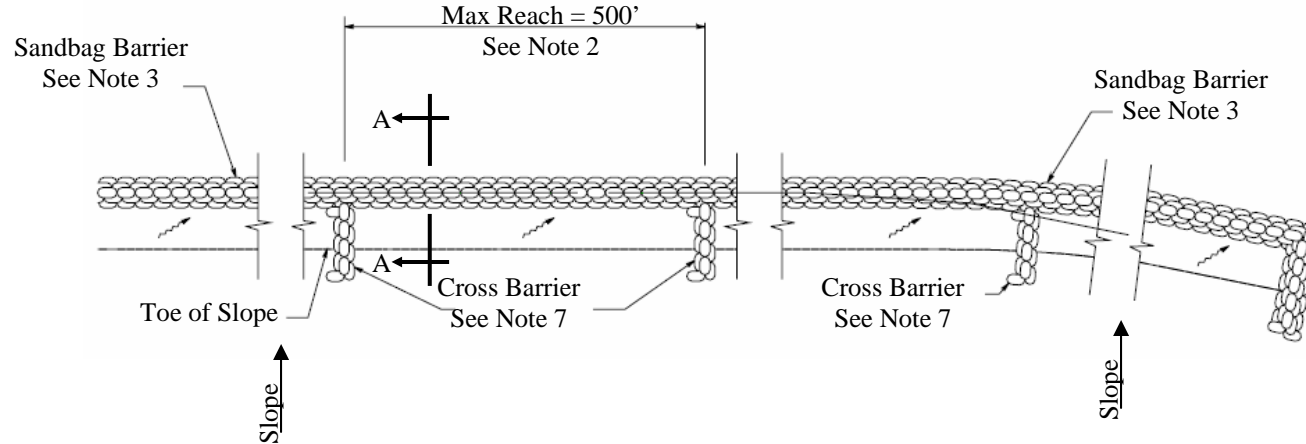

Detail "A"
Not to Scale

Notes:

1. Drainage area should not exceed 5 acres.
2. Construct the length of each reach so that the change in base elevation along the reach does not exceed $\frac{1}{2}$ the height of the linear barrier. In no case shall the reach length exceed 500'.
3. Stack sandbags at least three bags high with proper side slopes using a pyramid approach.
4. Locate sandbag barriers on a level contour.
 - a. Slopes between 20:1 and 2:1 (H:V): Sandbags should be placed at a maximum interval of 50 ft. (a closer spacing is more effective), with the first row near the slope toe.
 - b. Slopes 2:1 (H:V) or steeper: Sandbags should be placed at a maximum interval of 25 ft. (a closer spacing is more effective), with the first row placed near the slope toe.
5. Overlap butt joints of row beneath with each successive row.
6. The end of the barrier shall be turned up slope.
7. Cross barriers shall be a min of $\frac{1}{2}$ and a max of $\frac{2}{3}$ of the height of the linear barrier.
8. Sandbag material must conform to ASTM designation D3786 and ASTM designation D4355.
9. Dimensions may vary to fit field condition.
10. For Sandbag and Fill Material Specifications see SE-8 Sandbag Barrier, Materials.

Sandbag Barrier

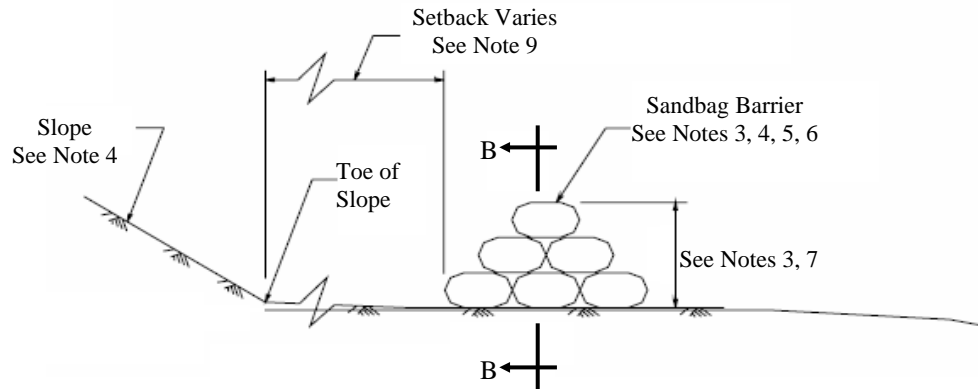

Section A-A
Not to Scale



Section B-B
See Note 5
Not to Scale

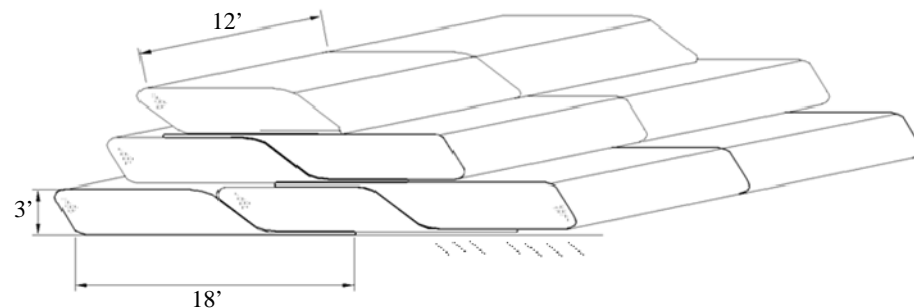

Stacked Sandbags
See Note 3
Not to Scale

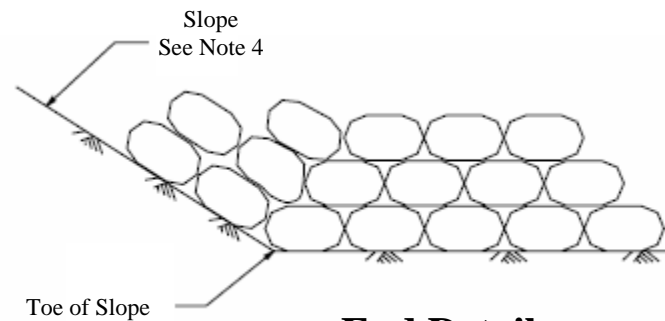

End Detail
See Note 6
Not to Scale



Overlapping Sandbags
Not to Scale

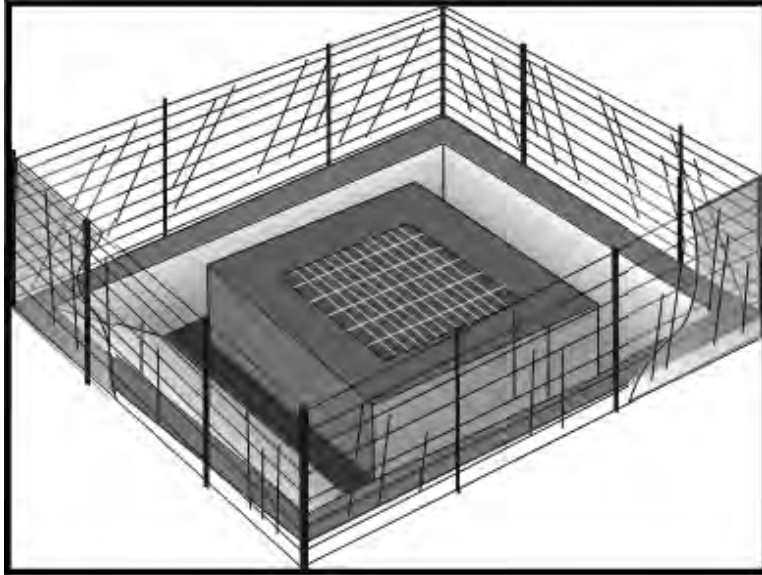

Description and Purpose

Storm drain inlet protection consists of a sediment filter or an impounding area around or upstream of a storm drain, drop inlet, or curb inlet. Storm drain inlet protection measures temporarily pond runoff before it enters the storm drain, allowing sediment to settle. Some filter configurations also remove sediment by filtering, but usually the ponding action results in the greatest sediment reduction.

Suitable Applications

Every storm drain inlet receiving sediment-laden runoff should be protected.

Limitations

- Drainage area should not exceed 1 acre.
- Not applicable for inlets within pedestrian or vehicle travel ways.
- Requires an adequate area for water to pond without encroaching into portions of the roadway subject to traffic.
- Inlet protection usually requires other methods of temporary protection to prevent sediment-laden storm water and non-storm water discharges from entering the storm drain system.
- Sediment removal may be difficult in high flow conditions or if runoff is heavily sediment laden. If high flow conditions are expected, use other onsite sediment trapping techniques in conjunction with inlet protection.
- Frequent maintenance is required.

Objectives

- EC – Erosion Control
- SE – Sediment Control ✓
- TR – Tracking Control
- WE – Wind Erosion Control
- NS – Non-Storm Water Management Control
- WM – Waste Management & Materials Pollution Control

Legend:

- ✓ Primary Objective
- ▲ Secondary Objective

Targeted Constituents

- Sediment ✓
- Nutrients
- Trash ✓
- Metals
- Bacteria
- Oil and Grease
- Organics

Potential Alternatives

- SE-1 Silt Fence
- SE-5 Fiber Rolls
- SE-6 Gravel Bag Berm
- SE-8 Sandbag Barrier

- For drainage areas larger than 1 acre, runoff should be routed to a sediment-trapping device designed for larger flows. See BMPs SE-2, Sediment Basin, and SE-3, Sediment Traps.
- Excavated drop inlet sediment traps are appropriate where relatively heavy flows are expected, and overflow capability is needed.

Implementation

General

Large amounts of sediment may enter the storm drain system when storm drains are installed before the upslope drainage area is stabilized, or where construction is adjacent to an existing storm drain. In cases of extreme sediment loading, the storm drain itself may clog and lose a major portion of its capacity. To avoid these problems, it is necessary to prevent sediment from entering the system at the inlets.

Inlet control measures presented in this manual should not be used for inlets draining more than one acre. Runoff from larger disturbed areas should be first routed through SE-2, Sediment Basin or SE-3, Sediment Trap. Different types of inlet protection are appropriate for different applications depending on site conditions and the type of inlet. Inlet protection methods not presented in this manual should be approved by the City DPP.

Design and Layout

Identify existing and planned storm drain inlets that have the potential to receive sediment-laden surface runoff. Determine if storm drain inlet protection is needed and which method to use.

- Limit upstream drainage area to 1 acre maximum. For larger drainage areas, use SE-2, Sediment Basin, or SE-3, Sediment Trap, upstream of the inlet protection device.
- The key to successful and safe use of storm drain inlet protection devices is to know where runoff will pond or be diverted.
 - Determine the acceptable location and extent of ponding in the vicinity of the drain inlet. The acceptable location and extent of ponding will influence the type and design of the storm drain inlet protection device.
 - Determine the extent of potential runoff diversion caused by the storm drain inlet protection device. Runoff ponded by inlet protection devices may flow around the device and towards the next downstream inlet. In some cases, this is acceptable; in other cases, serious erosion or downstream property damage can be caused by these diversions. The possibility of runoff diversions will influence whether or not storm drain inlet protection is suitable; and, if suitable, the type and design of the device.
- The location and extent of ponding, and the extent of diversion, can usually be controlled through appropriate placement of the inlet protection device. In some cases, moving the inlet protection device a short distance upstream of the actual inlet can provide more efficient sediment control, limit ponding to desired areas, and prevent or control diversions.
- Five types of inlet protection are presented below. However, it is recognized that other effective methods and proprietary devices exist and may be selected.
 - Filter Fabric Fence: Appropriate for drainage basins with less than a 5% slope, sheet flows, and flows under 0.5 cfs.

- Excavated Drop Inlet Sediment Trap: An excavated area around the inlet to trap sediment (SE-3).
- Gravel bag barrier: Used to create a small sediment trap upstream of inlets on sloped, paved streets. Appropriate for sheet flow or when concentrated flow may exceed 0.5 cfs, and where overtopping is required to prevent flooding.
- Block and Gravel Filter: Appropriate for flows greater than 0.5 cfs.
- Temporary Geotextile Insert: Application dependant on type and manufacturer.
- Select the appropriate type of inlet protection and design as referred to or as described in this fact sheet.
- Provide area around the inlet for water to pond without flooding structures and property.
- Grates and spaces around all inlets should be sealed to prevent seepage of sediment-laden water.
- Excavate sediment sumps (where needed) 1 to 2 ft. with 2:1 side slopes around the inlet.

Installation

- **DI Protection Type 1 - Filter Fabric Fence** - The filter fabric fence (Type 1) protection is shown in the attached figure. Similar to constructing a silt fence; see BMP SE-1, Silt Fence. Do not place filter fabric underneath the inlet grate since the collected sediment may fall into the drain inlet when the fabric is removed or replaced.
 - Excavate a trench approximately 6 in. wide and 6 in. deep along the line of the silt fence inlet protection device.
 - Place 2 in. by 2 in. wooden stakes, metal stakes or #4 rebar with cap around the perimeter of the inlet a maximum of 3 ft. apart and drive them at least 18 in. into the ground or 12 in. below the bottom of the trench. The stakes should be at least 48 in.
 - Lay fabric along bottom of trench, up side of trench, and then up stakes. See SE-1, Silt Fence, for details. The maximum silt fence height around the inlet is 24 in.
 - Staple the filter fabric (for materials and specifications, see SE-1, Silt Fence) to stakes. Use heavy-duty wire staples or wire at least 1 in. in length.
 - Backfill the trench with gravel or compacted earth all the way around.
- **DI Protection Type 2 - Excavated Drop Inlet Sediment Trap** - The excavated drop inlet sediment trap (Type 2) is shown in the attached figures. Install filter fabric fence in accordance with DI Protection Type 1. Size excavated trap to provide a minimum storage capacity calculated at the rate 67 yd³/acre of drainage area.
- **DI Protection Type 3 - Gravel bag** - The gravel bag barrier (Type 3) is shown in the figures. Flow from a severe storm should not overtop the curb. In areas of high clay and silts, use filter fabric and gravel as additional filter media. Construct gravel bags in accordance with SE-6, Gravel Bag Berm. Gravel bags should be used due to their high permeability.
 - Use sand bag made of geotextile fabric (not burlap) and fill with 0.75 in. rock or 0.25 in. pea gravel.
 - Construct on gently sloping street.
 - Leave room upstream of barrier for water to pond and sediment to settle.

- Place several layers of sand bags - overlapping the bags and packing them tightly together.
- Leave gap of one bag on the top row to serve as a spillway. Flow from a severe storm (e.g., 10 year storm) should not overtop the curb.
- **DI Protection Type 4 - Gravel Filter** - The gravel filter (Type 4) is shown in the figures. Gravel filters are suitable for curb inlets commonly used in residential, commercial, and industrial construction.
 - Place hardware cloth or comparable wire mesh with 0.5 in. openings over the drop inlet so that the wire extends a minimum of 1 ft. beyond each side of the inlet structure. If more than one strip is necessary, overlap the strips. Place filter fabric over the wire mesh.
 - Place wire mesh over the outside vertical face (open end) of the inlet to prevent stone from being washed through. Use hardware cloth or comparable wire mesh with 0.5 in. opening.
 - Pile washed aggregate against the wire mesh to the top of the inlet. Use 0.75 to 3 in aggregate.
- **DI Protection Type 5** – Temporary Geotextile Insert (proprietary) – Many types of temporary inserts are available. Most inserts fit underneath the grate of a drop inlet or inside a curb inlet and are fastened to the outside of the grate or curb. These inserts are removable and many can be cleaned and reused. Installation of these inserts differs between products and manufactures. Please refer to manufacturer instruction for installation of proprietary devices.

Costs

Average annual cost for installation and maintenance (one year useful life) is \$200 per inlet in California. Note that Hawaii's unit prices are higher than California's unit prices.

Inspection and Maintenance

- Inspect BMPs prior to forecast rain, daily during extended rain events, after rain events, weekly during the rainy season, and at two-week intervals during the non-rainy season.
- During flash flood warning or advisories from the National Weather Service DOH-CWB recommends that the contractor perform maintenance on all site BMPs followed by removal of inlet protection. At these times, public (human) health and safety is paramount to control of pollutants entering the waterways. Reinstall all inlet protection when warning or advisories ended.
- Filter Fabric Fences. If the fabric becomes clogged, torn, or degrades, it should be replaced. Make sure the stakes are securely driven in the ground and are in good shape (i.e., not bent, cracked, or splintered, and are reasonably perpendicular to the ground). Replace damaged stakes. Check for gaps in the fabric, where the fabric overlaps, and if the posts need cross bracing due to high water levels.
- Gravel Filters. If the gravel becomes clogged with sediment, it shall be carefully removed from the inlet and either cleaned or replaced. Since cleaning gravel at a construction site may be difficult, consider using the sediment-laden stone as fill material

and put fresh stone around the inlet. Inspect bags for holes, gashes, and snags, and replace bags as needed. Check gravel bags for proper arrangement and displacement.

- Sediment that accumulates in the BMP must be periodically removed in order to maintain BMP effectiveness. Sediment should be removed when the sediment accumulation reaches one-third of the barrier height. Sediment removed during maintenance may be incorporated into earthwork on the site or disposed at an appropriate location.
- Remove storm drain inlet protection once the drainage area is stabilized. Clean and regrade area around the inlet and clean the inside of the storm drain inlet as it must be free of sediment and debris at the time of final inspection.

References

Stormwater Management Manual for The Puget Sound Basin, Washington State Department of Ecology, Public Review Draft, 1991.

Stormwater Quality Handbooks - Construction Site Best Management Practices (BMPs) Manual, State of California Department of Transportation (Caltrans), November 2000.

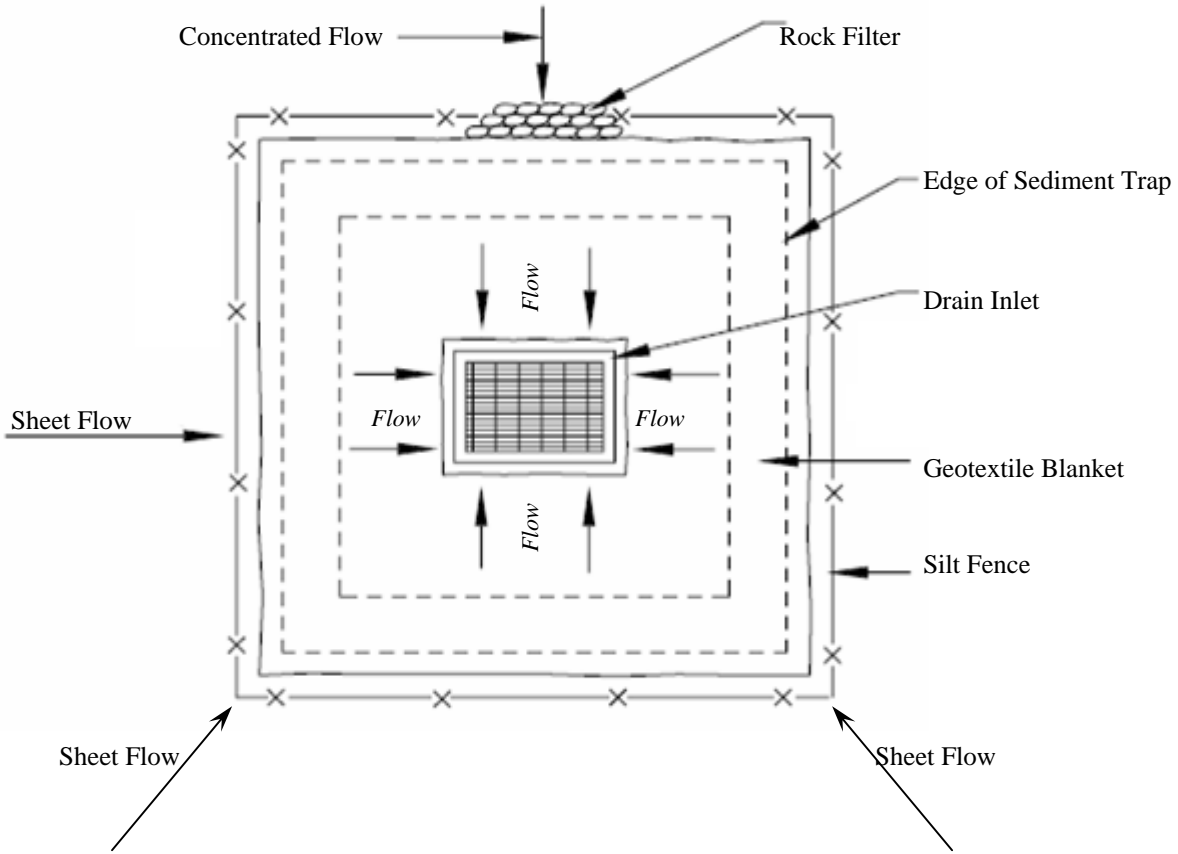

Detail "B"
Not to Scale

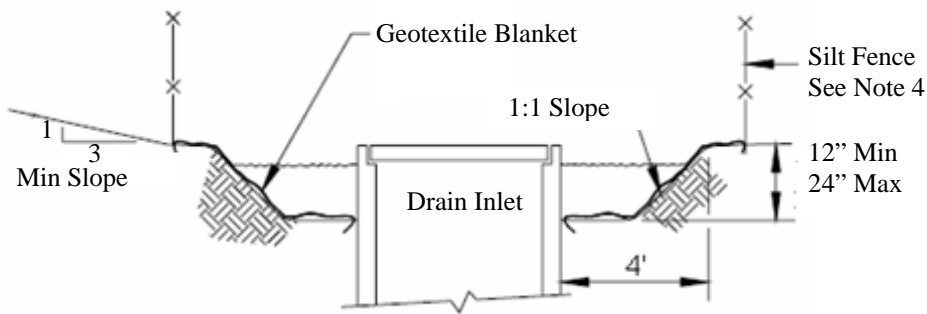

Notes:

1. For use in cleared and grubbed and in graded areas.
2. For concentrated flows, shape basin in 2:1 (L:W) ratio with length oriented towards direction of flow.
3. Size excavated trap to provide a minimum storage capacity calculated at the rate 67 yd³/acre of drainage area.
4. Refer to BMP SE-1, Silt Fence for construction.

DI Protection Type 2, Excavated Drop Inlet Sediment Trap

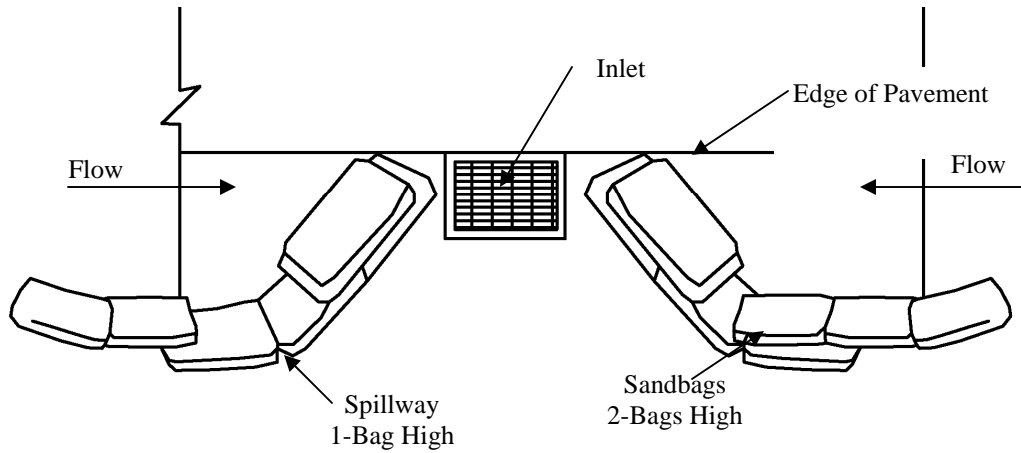

Typical Protection for Inlet on Sump, Detail "C"
Not to Scale

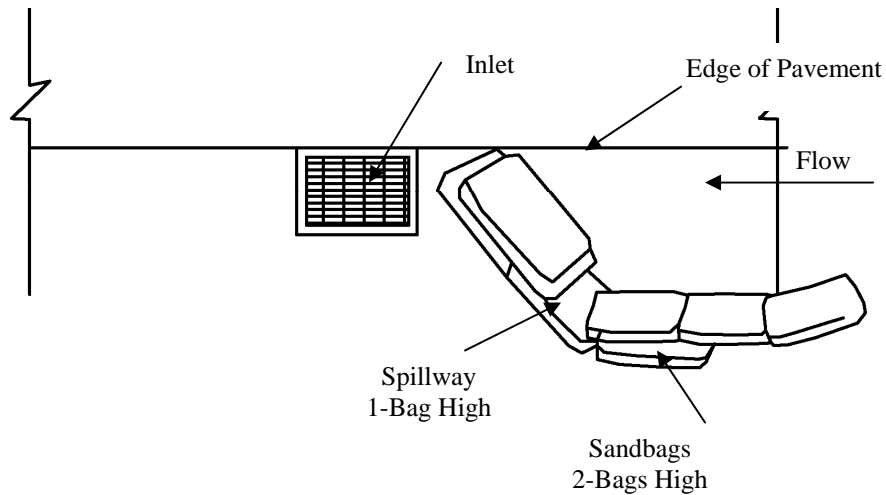

Typical Protection for Inlet on Grade, Detail "D"
Not to Scale

Notes:

1. Intended for short-term use. Not suitable for roads open to traffic.
2. Used to inhibit non-storm water flow.
3. Bags **should** be removed after adjacent operation is completed.
4. Not applicable in areas with high silts and clays without filter fabric.
5. Use sand bag made of geotextile fabric (not burlap) and fill with 0.75 in. rock or 0.25 in. pea gravel.
6. Construct on gently sloping street.
7. Leave room upstream of barrier for water to pond and sediment to settle.
8. Place several layers of sand bags - overlapping the bags and packing them tightly together.
9. Leave gap of one bag on the top row to serve as a spillway. Flow from a severe storm (e.g., 10 year storm) should not overtop the curb.
10. Do not use sandbags for roadways subject to traffic.
11. For traffic area, insert geotextile filter inserts instead of sandbags.

DI Protection Type 3, Gravel Bag

Detail "E"

Not to Scale

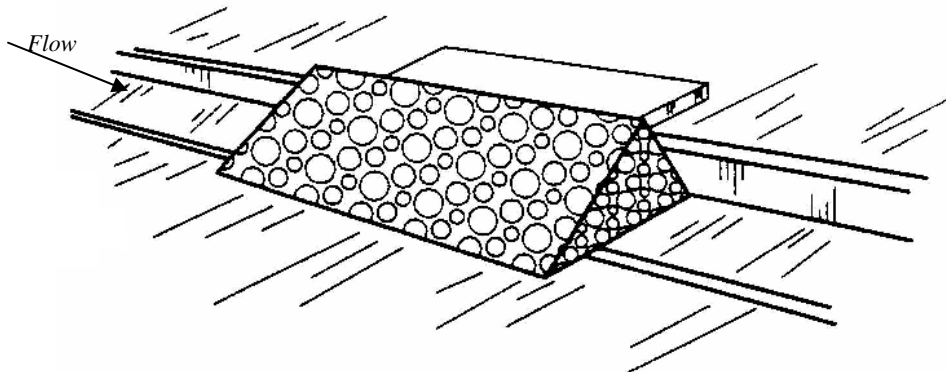

Section E-E

Not to Scale

Notes:

1. Place hardware cloth or comparable wire mesh with 0.5 in. openings over the drop inlet so that the wire extends a minimum of 1 ft. beyond each side of the inlet structure. If more than one strip is necessary, overlap the strips.
2. Place filter fabric over the wire mesh.
3. Place wire mesh over the outside vertical face (open end) of the inlet to prevent stone from being washed through. Use hardware cloth or comparable wire mesh with 0.5 in. opening.
4. Pile washed stone against the wire mesh to the top of the inlet. Use 0.75 to 3 in stones.
5. Do not use gravel within vehicle and pedestrian traffic areas.
6. For traffic areas, insert geotextile filter inserts instead of gravel filters.

DI Protection Type 4, Gravel and Wire Mesh Filter for Curb Inlet

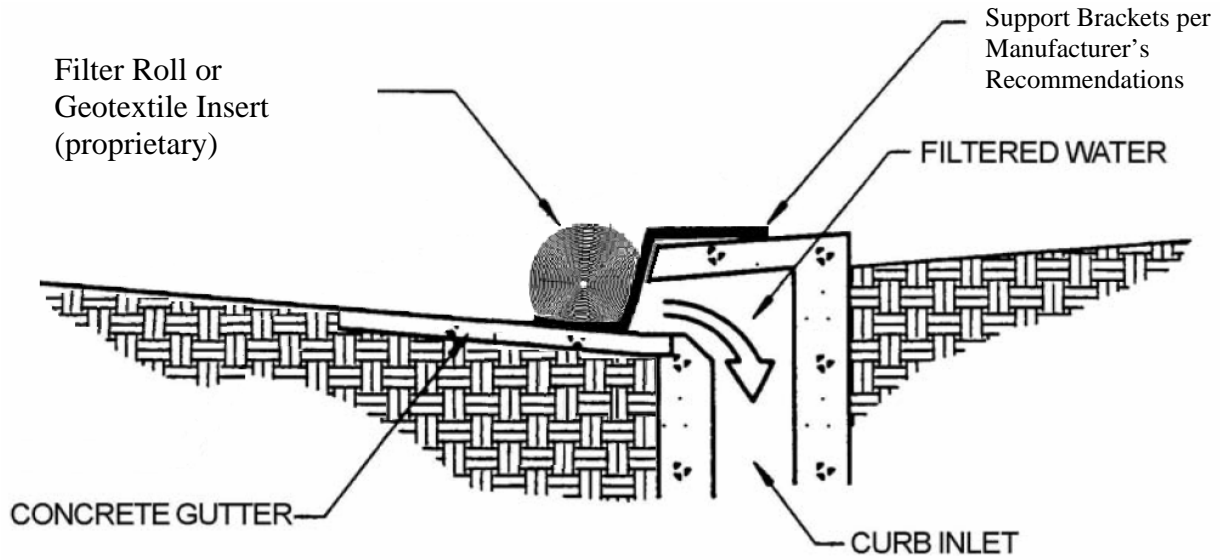

Detail "F"

Not to Scale and May Use Various Types of Geotextile Inserts

DI Protection Type 5, Filter Roll or Geotextile Insert with Supports for Curb Inlet

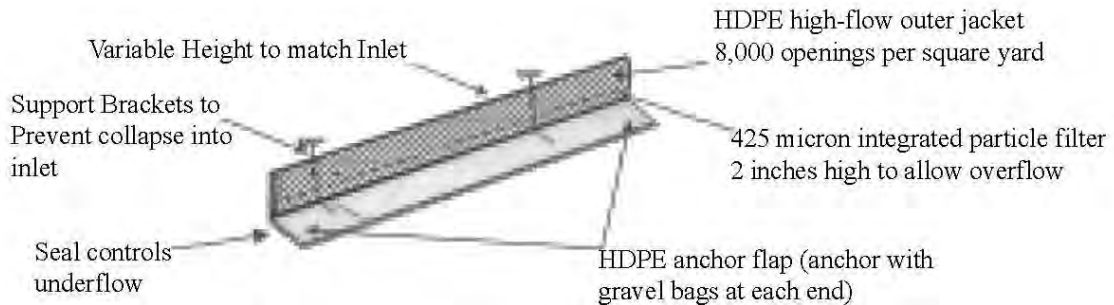

Detail "G"

Not to Scale and May Use Various Types and Styles of Geotextile Inserts

DI Protection Type 5, Geotextile Insert with Supports for Curb Inlet

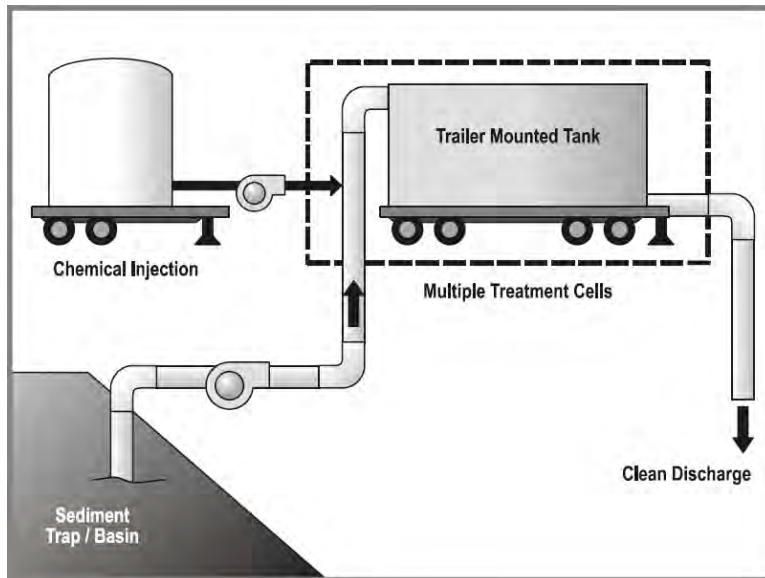

Description and Purpose

Chemical treatment includes the application of chemicals to storm water to aid in the reduction of turbidity caused by fine suspended sediment.

Suitable Applications

Chemical treatment can reliably provide exceptional reductions of turbidity and associated pollutants and should be considered where turbid discharges to sensitive wastes cannot be avoided using other BMPs. Typically, chemical use is limited to waters with numeric turbidity standards.

Limitations

The use of chemical treatment should have the advanced approval of the State of Hawaii Department of Health, Clean Water Branch (CWB).

- Chemical Treatment of storm water is relatively new and unproven technology in California or Hawaii;
- BMP has not been used often in California or Hawaii;
- Petroleum based polymers should not be used;
- Requires sediment basin or trailer mounted unit for chemical application;
- Batch treatment required, flow through continuous treatment not allowed;
- Requires large area;
- Limited discharge rates depending on receiving water body;

Objectives

- EC – Erosion Control
- SE – Sediment Control ✓
- TR – Tracking Control
- WE – Wind Erosion Control
- NS – Non-Storm Water Management Control
- WM – Waste Management & Materials Pollution Control

Legend:

- ✓ Primary Objective
- ▲ Secondary Objective

Targeted Constituents

- Sediment ✓
- Nutrients
- Trash
- Metals
- Bacteria
- Oil and Grease
- Organics

Potential Alternatives

None

- Labor intensive operation and maintenance; and
- Requires monitoring for non-visible pollutants.

Implementation

Turbidity is difficult to control once fine particles are suspended in storm water runoff from a construction site. Sedimentation ponds are effective at removing larger particulate matter by gravity settling, but are ineffective at removing smaller particulates such as clay and fine silt. Sediment ponds are typically designed to remove sediment no smaller than medium silt (0.02 mm). Chemical treatment may be used to reduce the turbidity of storm water runoff. Very high turbidities can be reduced to levels comparable to what is found in streams during dry weather.

Criteria for Chemical Treatment Product Use

Chemically treated storm water discharged from construction sites must be non-toxic to aquatic organisms. The following protocol should be used to evaluate chemicals proposed for storm water treatment at construction sites. Authorization to use a chemical in the field based on this protocol does not relieve the applicant from responsibility for meeting all discharge and receiving water criteria applicable to a site.

- Treatment chemicals must be approved by USEPA for potable water use.
- Petroleum-based polymers are prohibited.
- Prior to authorization for field use, jar tests should be conducted to demonstrate that turbidity reduction necessary to meet the receiving water criteria could be achieved. Test conditions, including but not limited to raw water quality and jar test procedures, should be indicative of field conditions. Although these small-scale tests cannot be expected to reproduce performance under field conditions, they are indicative of treatment capability.
- Prior to authorization for field use, the chemically treated storm water should be tested for aquatic toxicity. Applicable state Whole Effluent Toxicity Testing and Limits, should be used. Testing should use storm water from the construction site at which the treatment chemical is proposed for use or a water solution using soil from the proposed site.
- The proposed maximum dosage should be at least a factor of five lower than the no observed effects concentration (NOEC).
- The approval of a proposed treatment chemical should be conditional, subject to full-scale bioassay monitoring of treated storm water at the construction site where the proposed treatment chemical is to be used.
- Treatment chemicals that have already passed the above testing protocol do not need to be reevaluated. Contact the CWB for a list of treatment chemicals that may be approved for use.

Treatment System Design Considerations

The design and operation of a chemical treatment system should take into consideration the factors that determine optimum, cost-effective performance. It may not be possible to fully incorporate all of the classic concepts into the design because of practical limitations at construction sites. Nonetheless, it is important to recognize the following:

- The right chemical must be used at the right dosage. A dosage that is either too low or too high will not produce the lowest turbidity. There is an optimum dosage rate. This is a situation where the adage “adding more is always better” is not the case;
- The coagulant must be mixed rapidly into the water to insure proper dispersion;
- Experience has found that sufficient flocculation occurs in the pipe leading from the point of chemical addition to the settling or sediment basin;
- Since the volume of the basin is a determinant in the amount of energy per unit volume, the size of the energy input system can be too small relative to the volume of the basin;
- Care must be taken in the design of the withdrawal system to minimize outflow velocities and to prevent floc discharge. The discharge should be directed through a physical filter such as vegetated swale that would catch any unintended floc discharge; and
- A pH-adjusting chemical should be added into the sediment basin to control pH. Experience shows that the most common problem is low pH.

Treatment System Design

Chemical treatment systems should be designed as batch treatment systems using either ponds or portable trailer-mounted tanks. Flow-through continuous treatment systems are not allowed at this time.

A chemical treatment system consists of the storm water collection system (either temporary diversion or the permanent site drainage system), a sediment basin or sediment trap, pumps, a chemical feed system, treatment cells, and interconnecting piping.

The treatment system should use a minimum of two lined treatment cells. Multiple treatment cells allow for clarification of treated water while other cells are being filled or emptied. Treatment cells may be basins, traps or tanks. Portable tanks may also be suitable for some sites.

The following equipment should be located in an operation shed:

- The chemical injector;
- Secondary contaminant for acid, caustic, buffering compound, and treatment chemical;
- Emergency shower and eyewash; and
- Monitoring equipment which consists of a pH meter and a turbidimeter.

Sizing Criteria

The combination of the sediment basin or other holding area and treatment capacity should be large enough to treat storm water during multiple day storm events. See SE-2, Sediment Basin, for design criteria. Bypass should be provided around the chemical treatment system to accommodate extreme storm events. Runoff volume should be calculated using the Rational Method. Primary settling should be encouraged in the sediment basin/storage pond. A forebay with access for maintenance may be beneficial.

There are two opposing considerations in sizing the treatment cells. A larger cell is able to treat a larger volume of water each time a batch is processed. However, the larger the cell the longer the time required to empty the cell. A larger cell may also be less effective at flocculation and therefore require a longer settling time. The simplest approach to sizing the treatment cell is to multiply the allowable discharge flow rate times the desired drawdown time. A 4-hour

drawdown time allows one batch per cell per 8-hour work period, given 1 hour of flocculation followed by 2 hours of settling.

The permissible discharge rate governed by potential downstream effect can be used to calculate the recommended size of the treatment cells. The following discharge flow rate limits apply absent any State Department of Agriculture requirements:

- If the discharge is direct or indirect to a stream, the discharge flow rate should not exceed 50 percent of the peak flow rate for all events between the 2-year and the 10-year, 1-hour event;
- If discharge is occurring during a storm event equal to or greater than the 10-year storm the allowable discharge rate is the peak flow rate of the 10-year, 1-hour event;
- Discharge to a stream should not increase the stream flow rate by more than 10 percent;
- If the discharge is directly to a lake or major receiving water there is no discharge flow limit;
- If the discharge is to a municipal storm drainage system, the allowable discharge rate may be limited by the capacity of the public system. It may be necessary to clean the municipal storm drainage system prior to the start of the discharge to prevent scouring solids from the drainage system; and
- Runoff rates may be calculated using the Rational Method, unless another method is required by the City.

Costs

Costs for chemical treatment may be significant due to equipment required and cost of chemicals. The cost is offset by the ability to reduce some use of other onsite erosion control BMPs and the reuse of equipment (e.g., pumps and dosing equipment). The incremental cost is generally less than 1% of the total construction costs.

Inspection and Maintenance

Chemical treatment systems must be operated and maintained by individuals with expertise in their use. Chemical treatment systems should be monitored continuously while in use.

The following monitoring should be conducted. Test results should be recorded on a daily log kept on site.

Operational Monitoring

- pH conductivity (as a surrogate for alkalinity), turbidity, and temperature of the untreated storm water;
- Total volume treated and discharged;
- Discharge time and flow rate;
- Type and amount of chemical used for pH adjustment;
- Amount of polymer used for treatment; and
- Settling time.

Compliance Monitoring

- pH and turbidity of the treated storm water; and
- pH and turbidity of the receiving water.

Bio-monitoring

Treated storm water should be tested for acute (lethal) toxicity. Bioassays should be conducted by a laboratory accredited by the State of Hawaii. The performance standard for acute toxicity is no statistically significant difference in survival between the control and 100 percent chemically treated storm water.

Acute toxicity tests should be conducted with the approved species and protocols by the CWB.

All toxicity tests should meet quality assurance criteria and test conditions accepted by CWB.

Bioassays should be performed on the first five batches and on every tenth batch thereafter or as otherwise approved by the CWB. Failure to meet the performance standard should be immediately reported to the CWB.

Discharge Compliance:

Prior to discharge, each batch of treated storm water should be sampled and tested for compliance with pH and turbidity limits. These limits may be established by the water quality standards or a site-specific discharge permit. Sampling and testing for other pollutants may also be necessary at some sites. Turbidity should be within 5 NTUs of the background turbidity. Background is measured in the receiving water, upstream from the treatment process discharge point. pH should be within the range of 6.5 to 8.5 standard units and not cause a change in the pH of the receiving water of more than 0.2 standard units. It is often possible to discharge treated storm water that has a lower turbidity than the receiving water and that matches the pH.

Treated storm water samples and measurements should be taken from the discharge pipe or another location representative of the nature of the treated storm water discharge. Samples used for determining compliance with the water quality standards in the receiving water should not be taken from the treatment pond to decanting. Compliance with the water quality standards is determined in the receiving water.

Operator Training:

Each contractor who intends to use chemical treatment should be trained by an experienced contractor on an active site for at least 40 hours.

Standard BMPs:

Erosion and sediment control BMPs should be implemented throughout the site to prevent erosion and discharge of sediment.

Sediment Removal and Disposal

- Sediment should be removed from the storage or treatment cells as necessary. Typically, sediment removal is required at least once during a wet season and at the decommissioning of the cells. Sediment remaining in the cells between batches may enhance the settling process and reduce the required chemical dosage.
- Sediment may be incorporated into the site away from drainages.

References

Hawaii Administrative Rules 11-54 Water Quality Standards.

Stormwater Management Manual for Western Washington, Volume II – Construction Stormwater Pollution Prevention, Washington State Department of Ecology, August 2001.

Stormwater Quality Handbooks - Construction Site Best Management Practices (BMPs) Manual, State of California Department of Transportation (Caltrans), November 2000.

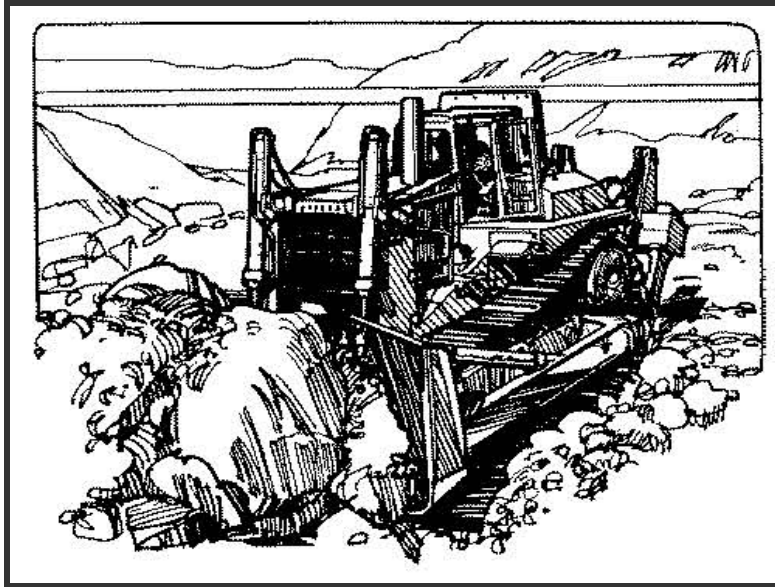

Description and Purpose

Proper location of potential sources of sediment can reduce the generation of erosion and sediment from construction sites.

Suitable Applications

Locating potential sources of sediment to minimize the discharge of pollutants should be considered on all projects. This is especially true where runoff goes either directly or indirectly to Class 1 or Class AA waters.

Approach

- Sequence construction so that haul roads and stockpiles are buffered with planted areas prior to discharging offsite.
- Separate/Divert offsite runoff where possible, flowing through the construction site without going over bare ground.
- Locate stockpiles away from waterways or low spots.
- Maintain swales and natural drainage ways in vegetated condition.
- Preserve trees and other existing vegetation. Vegetation along the perimeter of the site provides an effective buffer against sediment leaving the construction site.
- Use naturally level area for parking during construction.

Objectives

EC – Erosion Control	▲
SE – Sediment Control	√
TR – Tracking Control	
WE – Wind Erosion Control	
NS – Non-Storm Water Management Control	
WM – Waste Management & Materials Pollution Control	

Legend:

- √ Primary Objective
- ▲ Secondary Objective

Targeted Constituents

Sediment	√
Nutrients	√
Trash	
Metals	
Bacteria	
Oil and Grease	
Organics	√

Potential Alternatives

None

Requirements

- Maintenance:
 - Inspect regularly and after rain for damage; and
 - Provide mulching, grassing other ground cover to reduce bare areas.

Limitations

Prevention should be supplemented with mulching, planting and structural controls such as berms, silt fences, and silt basins.

References

California Storm Water Best Management Practices Handbooks, Construction Activity Best Management Practice Handbook, March 1993, Camp Dresser & McKee, et al. For the California Storm Water Quality Task Force.

City & County of Honolulu, Best Management Practices Manual for Construction Sites in Honolulu, Department of Environmental Services, May 1999.

Erosion and Sediment Control Guide for Hawaii, March 1981, USDA Soil Conservation Service.

Hawaii Administrative Rules, Title 11, Chapter 54, Water Quality Standards.

Planning and Design Manual for the Control and Erosion, Sediment, and Stormwater; A Cooperative Effort by: USDA Natural Resources Conservation Service, Mississippi Department of Environmental Quality, and the Mississippi Soil & Water Conservation Commission.

Rules Relating to Soil Erosion Standards and Guidelines, April 1999, Department of Planning and Permitting, City and County of Honolulu.

Storm Water Management for Construction Activities: Developing Pollution Prevention Plans and Best Management Practices, September 1992, U.S. Environmental Protection Agency.

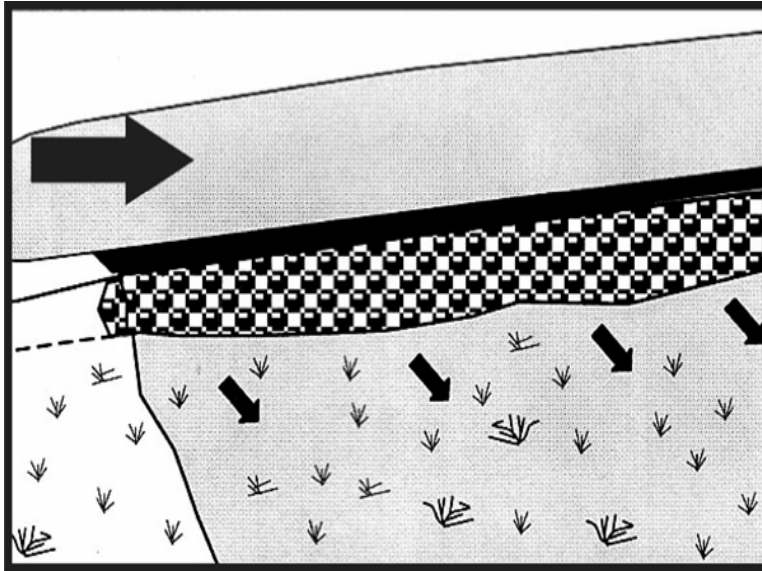

Description and Purpose

A device used at outlets that converts concentrated flow to sheet flow preventing erosion of the receiving area. Tops of channels, earthen berms, or rigid weir-like structures may function as level spreaders.

Suitable Applications

- Flat or gentle sloping areas.
- Outlets for dikes and diversions.

Installation & Implementation

- Construct on undisturbed soil.
- Do not construct on fill material.
- Locate where re-concentration of water will not occur.
- A stabilized and well vegetated slope of less than 10% should be located below the level spreader.
- Filter runoff containing high sediment loads through a sediment-trapping device prior to release to the level spreader.
- Incorporate a rigid outlet lip design for high discharge flows.
- Zero percent grade on the spreader lip is necessary for uniform sheet flow.
- Avoid operating vehicles and heavy equipment on the level spreader to maintain a smooth level surface for the overflow weir.

Objectives

- EC – Erosion Control ▲
- SE – Sediment Control ✓
- TR – Tracking Control
- WE – Wind Erosion Control
- NS – Non-Storm Water Management Control
- WM – Waste Management & Materials Pollution Control

Legend:

- ✓ Primary Objective
- ▲ Secondary Objective

Targeted Constituents

- Sediment ✓
- Nutrients ✓
- Trash
- Metals
- Bacteria
- Oil and Grease
- Organics ✓

Potential Alternatives

None

Requirements

- Maintenance & Inspection:
 - Conduct inspections of the level spreaders prior to the rainy season and after rain events exceeding the design storm intensity (2-year recurrence interval, 1 hour duration, unless otherwise directed).
 - Inspect level spreader channel for accumulation of debris and sediment regularly and remove debris and sediment.
 - Verify a slope of zero percent along the spreader lip.
 - Inspect the discharge area for signs of erosion or concentrated flow.

Limitations

Not applicable to sediment laden runoff.

References

Knoxville BMP Manual, 2003.

State of Hawaii DOT Highway Division, Construction BMP Field Manual, February 2007.

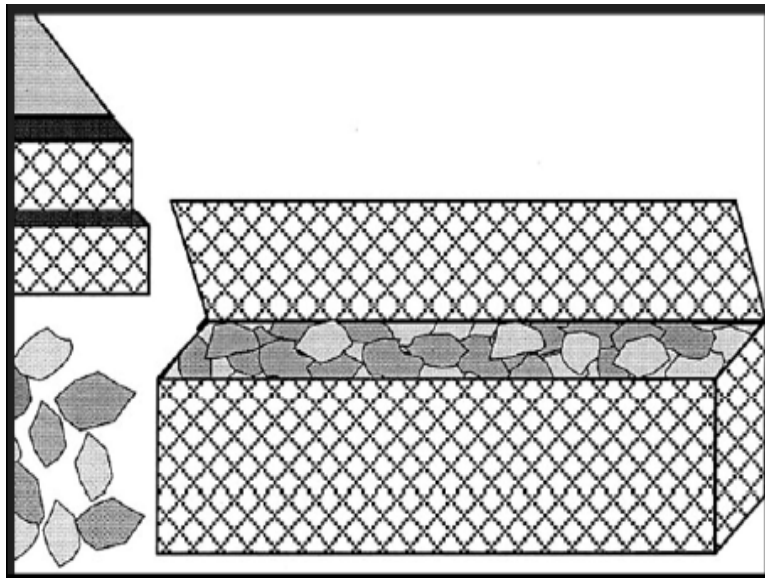

Description and Purpose

Lined drainageway to stabilize the flow channel along steep slopes.

Suitable Applications

- Use of rip-rap inflow protection applies to slopes between 10:1 and 4:1 (H:V).
- Use of gabion inflow protection applies to slopes exceeding 4:1 (H:V).

Limitations

- None identified.

Implementation

Rip-Rap

- 2:1 (H:V) side slopes, 3 foot minimum bottom width, and 1 foot minimum depth.
- Line channel with 4 to 12 inch rip-rap at a depth of 18 inches.
- Install geotextile filter fabric under all rip-rap.
- Gabion inflow protection may be used in lieu of rip-rap inflow protection.
- Blend rip-rap into existing ground.

Gabion

- Construct 2:1 (H:V) side slopes, 3 foot bottom width, and 1 foot deep from 9' x 3' x 9" gabion baskets.
- Install geotextile filter fabric under all gabion baskets.

Objectives

EC – Erosion Control	▲
SE – Sediment Control	√
TR – Tracking Control	
WE – Wind Erosion Control	
NS – Non-Storm Water Management Control	
WM – Waste Management & Materials Pollution Control	

Legend:

- √ Primary Objective
- ▲ Secondary Objective

Targeted Constituents

Sediment	√
Nutrients	
Trash	
Metals	
Bacteria	
Oil and Grease	
Organics	

Potential Alternatives

None

- Fill gabion baskets with 4” to 7” stone.
- Install gabions in accordance with manufacturer’s recommendations.

Inspection and Maintenance

- Inspect periodically and after significant rain events.
- Remove accumulated sediment at inlet structure.

Costs

All of the above are low cost measures.

References

Knoxville BMP Manual, 2003.

State of Hawaii DOT, Highways Division Construction BMP Field Manual, September 2006.

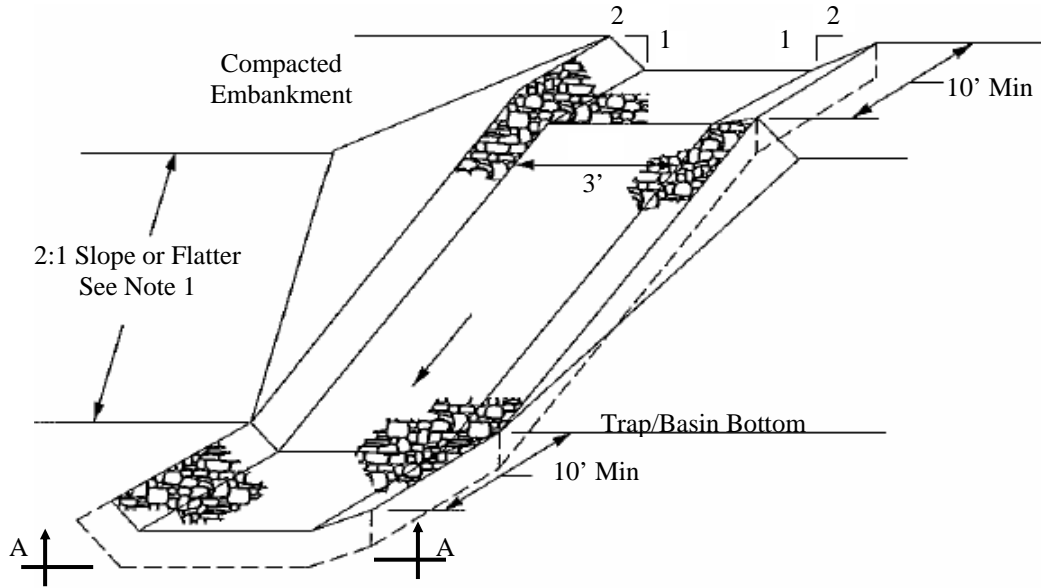

Detail "A"
Not to Scale

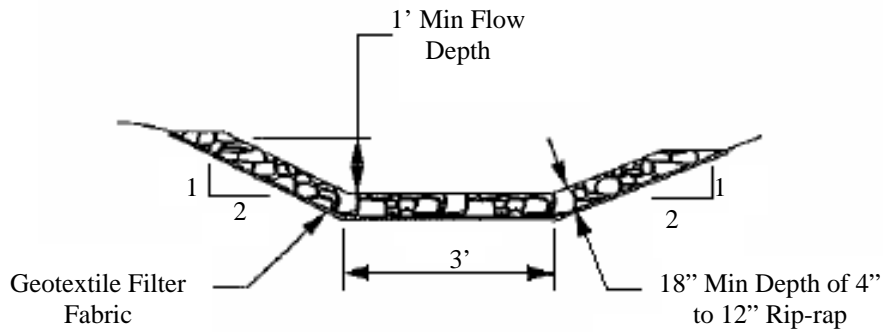

Section A-A
Not to Scale

Notes:

1. 2:1 (H:V) side slopes, 3 foot minimum bottom width, and 1 foot minimum depth.
2. Line channel with 4 to 12 inch rip-rap at a depth of 18 inches.
3. Install geotextile filter fabric under all rip-rap.
4. Gabion inflow protection may be used in lieu of rip-rap inflow protection.
5. Blend rip-rap into existing ground.

Rip-Rap Inflow Protection

Source: Maryland Standards and Specifications for Soil Erosion and Sediment Control, 1994

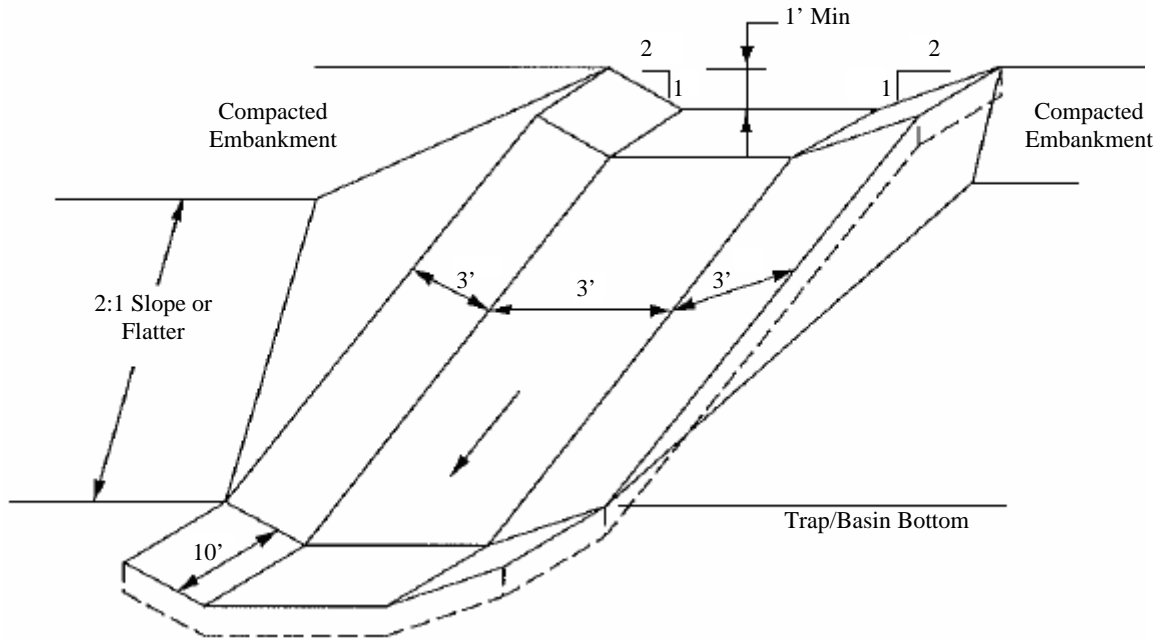

Detail "B"
Not to Scale

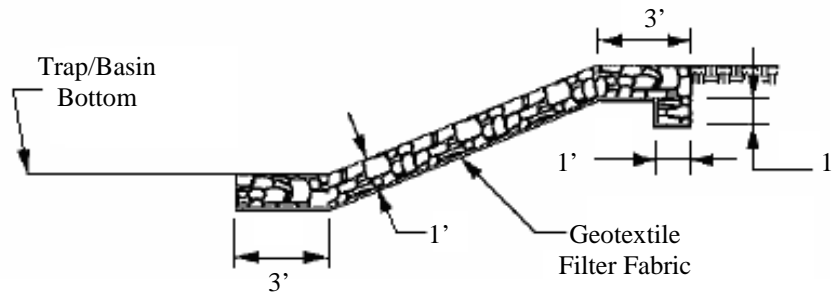

Centerline Profile View
Not to Scale

Notes:

1. Construct 2:1 (H:V) side slopes, 3 foot bottom width, and 1 foot deep from 9' x 3' x 9" gabion baskets.
2. Install geotextile filter fabric under all gabion baskets.
3. Fill gabion baskets with 4" to 7" stone.
4. Install gabions in accordance with manufacturer's recommendations.

Gabion Inflow Protection

Source: Maryland Standards and Specifications for Soil Erosion and Sediment Control, 1994

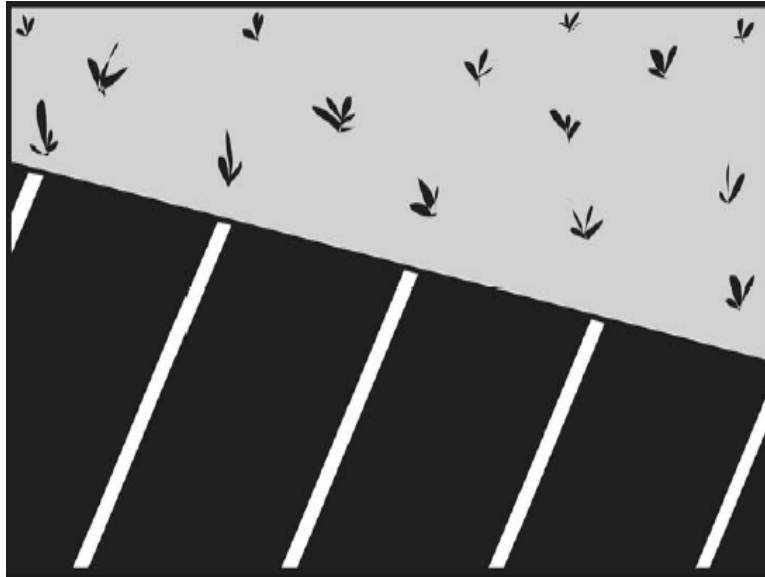

Description and Purpose

Vegetative buffer strips and channels protect soil from erosion, increase infiltration, and remove sediment from surface runoff. Located adjacent to pollutant sources such as construction sites, vegetated buffer strips also provide protection to downstream receiving inlets or water bodies.

Suitable Applications

- Any site which is suitable for establishment of vegetation.
- Vegetated buffer strips are appropriate for uncurbed, paved areas; steep and potentially unstable slopes; and areas adjacent to sensitive water bodies.
- Vegetated channels are appropriate for surface runoff conveyed by channels to downstream inlets or receiving waters.

Limitations

- Site conditions such as availability of land.
- Flow depth and vegetative condition determine BMP effectiveness.
- May require irrigation to maintain vegetation.
- High maintenance requirements may exist depending on the design condition of the vegetation.
- Unless existing vegetation is used as a buffer strip, an area will need to be provided specifically for a buffer strip and vegetation will need to be established.
- Maintaining sheet flow in buffer strips may be difficult.

Objectives

EC – Erosion Control	
SE – Sediment Control	√
TR – Tracking Control	
WE – Wind Erosion Control	
NS – Non-Storm Water Management Control	
WM – Waste Management & Materials Pollution Control	

Legend:

- √ Primary Objective
- ▲ Secondary Objective

Targeted Constituents

Sediment	√
Nutrients	
Trash	
Metals	√
Bacteria	
Oil and Grease	√
Organics	

Potential Alternatives

None

- Vegetated channels require a larger area than lined channels.
- Vegetated channels require gradual slopes since runoff with high flow velocity may flow over grass rather than through it.

Implementation

Refer to EC-3 (Preservation of Existing Vegetation) in this manual if existing vegetation will be used as a buffer strip.

Installation of a buffer strip with new vegetation should comply with the following:

- Prior to cultivation of the designated buffer strip area, remove and dispose of all weeds and debris in accordance with contract documents;
- During construction, strip and stockpile good topsoil for surface preparation purposes prior to planting activities;
- Plant the area upon completion of grading in the area;
- Fine grade and roll areas to be planted after cultivating soil and, if applicable, installing the irrigation system;
- Provide additional watering or irrigation of vegetation to supplement rainfall until vegetation has been established;
- Fertilize vegetation in accordance with manufacturers' instructions and grass/soil requirements determined by testing of the soil;
- Vehicular traffic passing through vegetated buffer strips or channels should be avoided to protect vegetation from damage and maximize its effectiveness;
- Applicable regulations and manufacturers' instructions when applying fertilizers, pesticides, soil amendments, or chemicals;
- During seeding activities:
 - Add soil amendments such as fertilizer when preparing seedbed. Apply mulch after seeding to protect vegetation during establishment. Select an appropriate seed mixture based on site conditions. Dense grasses are more effective in reducing flow velocities and removing sediment. Thick root structures are necessary for erosion control;
 - Use proper equipment and methods to ensure uniform distribution and appropriate seed placement; and
 - Overseed, repair bare spots, and apply additional mulch as necessary.
- During sodding activities:
 - Protect sod with tarps or other types of protective covering during delivery and do not allow sod to dry between harvesting and placement;
 - Any irregular or uneven areas observed prior to or during the plant establishment period should be restored to a smooth and even appearance;
 - Prior to placing sod, ground surface should be smooth and uniform;
 - Areas, which will be planted with sod and are adjacent to paved surfaces such as sidewalks and concrete headers, should be 1.5±0.25 inches below the top grade of the paved surface after fine grading, rolling, and settlement of the soil;

- Ends of adjacent strips of sod should be staggered a minimum of 24 inches;
- Edges and ends of sod should be placed firmly against paved borders;
- After placement of the sod, lightly roll sodded area to eliminate air pockets and ensure close contact with the soil;
- After rolling, water the sodded area to moisten the soil to a depth of 4 inches;
- Do not allow sod to dry;
- Avoid planting sod during extremely hot or wet weather; and
- Sod should not be placed on slopes steeper than 3:1 (H:V) if the area will be mowed.

Costs

All of the above are low cost measures.

Inspection and Maintenance

- Inspect weekly and after significant rain events until vegetation is established. Repair eroded or damaged areas as necessary.
- Maintenance activities include mowing, weeding, and verification of a properly operating irrigation system, if applicable.
- Properly remove and dispose of clippings from mowing and trimming.

References

Knoxville BMP Manual, 2003.

State of Hawaii DOT, Highways Division Construction BMP Field Manual, September 2006.

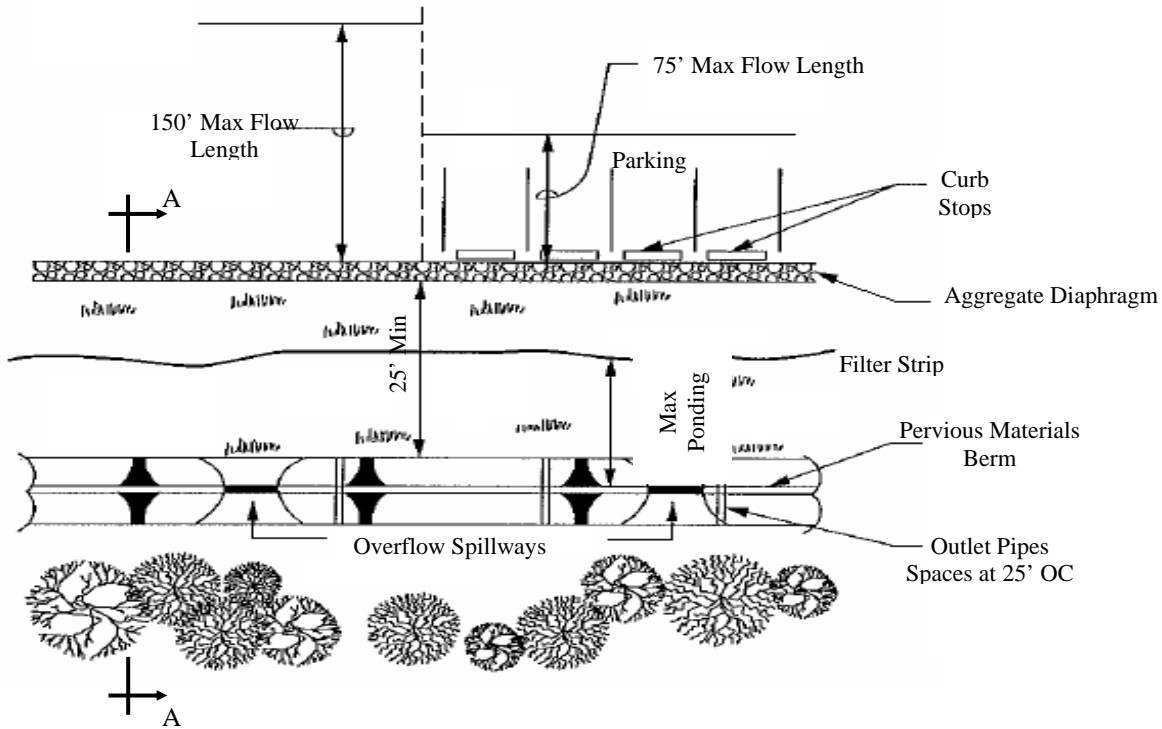

Detail "A"

Plan View, Not to Scale

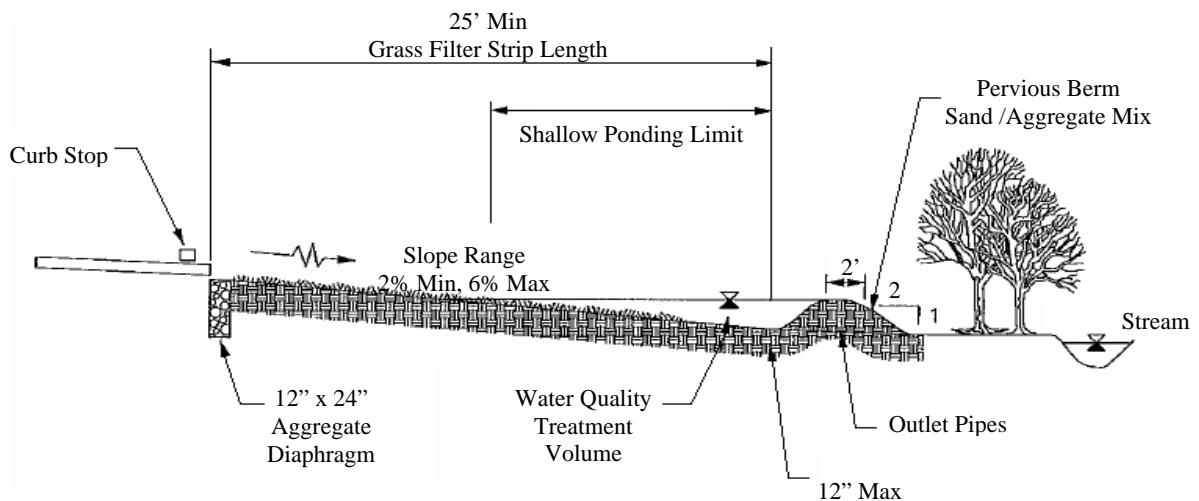

Section A-A

Not to Scale

Notes:

1. For Implementation see City and County of Honolulu Storm Water Construction BMP Details SE-14 (Vegetated Buffer Strips and Channels).
2. If existing vegetation will be used as a buffer strip, EC-2 (Preservation of Existing Vegetation).

Typical Vegetated Buffer Strip

Source: Prince George's County, *Low-Impact Development Design Strategies: An Integrated Environmental Design Approach*, 1999



Description and Purpose

Composite socks and berms act as three-dimensional biodegradable filtering structures to intercept runoff where sheet flow occurs and are generally placed at the perimeter or at intervals on sloped areas. Compost socks are generally a mesh sock containing compost and a compost berm is a dike of compost, trapezoidal in cross section. When employed to intercept sheet flow, both BMPs are placed perpendicular to the flow of the runoff allowing filtered runoff to pass through the compost and retaining sediment (and potentially other pollutants in runoff). A compost sock can be assembled on site by filling a mesh sock with compost (i.e. using a pneumatic blower or similar) or they can be manufactured off site and delivered to the site for installation. The compost berm should be constructed using a backhoe or equivalent and/or a pneumatic delivery (blower) system and should be properly compacted after placement. Compost socks and berms act as filters, reduce runoff velocities, and in some cases, aid in future establishment of vegetation.

Compost is organic, biodegradable, and renewable. Compost provides soil structure that allows water to infiltrate the compost medium which helps reduce rill erosion and the retained moisture promotes seed germination and vegetation growth, in addition to providing organic matter and nutrients important for fostering vegetation. Compost improves soil quality and productivity. The compost of the compost sock or berm can be selected to target site-specific objectives in capturing sediment and other pollutants, supporting certain vegetation, or additional erosion controls.

Objectives

EC – Erosion Control	▲
SE – Sediment Control	√
TR – Tracking Control	
WE – Wind Erosion Control	
NS – Non-Storm Water Management Control	
WM – Waste Management & Materials Pollution Control	

Legend:

- √ Primary Objective
- ▲ Secondary Objective

Targeted Constituents

Sediment	√
Nutrients	
Trash	
Metals	▲
Bacteria	▲
Oil and Grease	▲
Organics	

Potential Alternatives

- SE-1 Silt Fence
- SE-5 Fiber Rolls
- SE-6 Gravel Bag Berm
- SE-8 Sandbag Barrier

Compost is typically derived from leaf/yard trimmings, or wood. The primary targeted sources of compost are products of the City green waste programs. Compost is organic and biodegradable and in most cases can be left onsite once construction activity is completed. There are many types of compost with a variety of properties with specific functions, and accordingly compost selection is an important design consideration in the application of this type of erosion and sediment control.

Suitable Applications

- Along toe, top, face, and at grade breaks of exposed and erodible slopes to shorten slope length and spread runoff as sheet flow (compost berms should only be used at the top of slopes or on slopes 4:1 (H:V) or less, all other slopes applications should use compost socks or other BMPs);
- Along perimeter of project;
- As check dams in unlined ditches (socks only);
- Down-slope of exposed soil areas; and
- Around temporary stockpiles.

Compost socks and berms do not require special trenching or BMP removal as compared to other sediment control methods (e.g. silt fences or fiber rolls). Since installing compost socks does not require trenching or disturbing the earth, compost socks can be effectively installed during a rain event if immediate sediment and erosion control is required. Compost socks and berms can remain in place after earth disturbing activities are completed or the compost components can be spread over the site providing nutrients for plant growth and augmenting soil structure. BMPs that remain in place are particularly advantageous below embankments, especially adjacent to streams, by limiting re-entry and the continued disturbance to sensitive areas.

Compost socks can be manufactured in 20' coils, similar to other sediment retention fiber roll (SRFR) devices (straw wattles, etc.) and placed on a pallet for easy storage, transportation, and installation. Pre-made compost sock coils can be stored on the site in preparation for BMP maintenance activities and rain events.

Compost can be pre-seeded prior to application (recommended by EPA for construction site storm water runoff control, USEPA Website-Compost Filter Socks) or seeded after installation (primarily for compost berms).

Limitations

- Compost can potentially leach nutrients (dissolved phosphorous and nitrogen) into runoff and potentially impact water quality. Compost should not be used directly upstream from nutrient impaired waterbodies;
- Compost may also contain other undesirable constituents that are detrimental to water quality choose source of compost selectively;
- Application by hand is time intensive and potentially costly. Using a pneumatic blower truck is the recommended cost effective method of distribution;
- Heavy vegetation should be removed to ensure close contact of compost with the existing ground surface;

- Compost socks and berms should not be employed at the base of slopes greater than 2:1. They can be employed in combination with other erosion control methods for steeper slopes;
- Difficult to move once saturated;
- Compost berms should not be applied in areas of concentrated flows;
- Compost socks and berms are easy to fix; however they are susceptible to damage by frequent traffic. Compost socks can be used around heavy machinery, but regular disturbance decreases sock performance; and
- Different strength socks are available by compost sock manufacturers, select sock which is of sufficient strength to handle anticipated disturbances.

Implementation

Compost Materials

- Compost should meet or exceed AASHTO R 51-10, Standard Specification for Compost for Erosion/Sediment Control (Filter Berms and Filter Socks);
- Compost quality shall comply with all local, state, and Federal requirements;
- Particle size is an important parameter for selecting compost. Well consolidated coarser grades of compost (e.g. mixture of small and larger pieces) perform better for filtration objectives, while finer grades support vegetation better. Particle size of the compost should be selected based on site conditions, such as expected participation rates, filtration goals, and/or long term plant nutrient requirements;
- Compost moisture should be considered for composition quality and application purposes. A range of 30-50% is typical. Compost that is too dry is hard to apply and compost that is too wet is more difficult (and more expensive) to transport. For arid or semi-arid areas, or for application during the dry season, use compost with greater moisture content than areas with wetter climates. For wetter or more humid climates or for application during the wet season, drier composts can be used as the compost will absorb moisture from the ambient air;
- If vegetation establishment is a desired function of the compost, a compost sample should be inspected by a qualified individual;
- Organic content of the compost is also important and should range from 30-65% depending on site conditions and uses for vegetation establishment;
- Compost should not be derived from mixed municipal solid waste or biosolids and should be free of visible contaminants;
- Compost used should not emit objectionable odors; and
- Compost should be weed and alien plant free.

Installation

- Prior to application, prepare locations for socks and/or berms by removing brush and thick vegetation. The compost of the sock and/or berm should be allowed to come in full contact with the ground surface;
- If manufacturing on site select method to apply the compost berm or fill sock. A pneumatic blower is most cost effective and most adaptive in applying compost to steep, rough terrain, and hard to reach locations;
- If compost sock has been manufactured off site, the sock shall be manufactured in pre-made lengths that are easily, safely, and efficiently handled by construction laborers;
- Overlap the ends of adjoining sock lengths by a minimum of 6”;
- The compost of the berm should be distributed evenly to the surface, compacted, and shaped trapezoidal (refer to AASHTO Specification R 51-10);
- Compost socks can be assembled on site by filling mesh socks with selected compost. Mesh socks can be tied at one end, filled, and then tied at the other end. The ends of socks can be interlocked until the desired length is achieved. Alternatively, use a filter sock equivalent to length of slope if practicable. The sock diameter is a function of slope steepness and length (refer to AASHTO Specification R 51-10) – typically 8” to 18” in diameter;
- Compost socks are typically placed in contours perpendicular to sheet flow. They can also be placed in V formation on a slope. Compost socks must be anchored, typically stakes, through center of the sock although alternative anchor methods may be prescribed by the compost sock manufacturer;
- Turn ends of socks up slope to prevent flow around ends;
- When used as a Slope Interruption Device (SID) locate compost socks and berms on level contours spaced as follows:
 - Slope inclination of 4:1 (H:V) or flatter: Socks and/or berms should be place at a maximum interval of 35-40 ft.;
 - Slope inclination between 4:1 and 2:1 (H:V): Socks (use of berms not recommended) should be placed at a maximum interval of 25-30 ft. (a closer spacing is more effective); and
 - Slope inclination of 2:1 (H:V) or greater: Socks should be placed at maximum interval of 15-20 ft.
- If used at toe of slopes, the compost sock or berm should at minimum of 5 to 10 feet away from toe;
- Compost socks and berms can be effective over rocky ground if secured properly;
- It is recommended that the drainage areas of these compost BMPS do not exceed 0.25 acre/100 foot placement interval and runoff does not exceed 1 CFS; and
- Layout in accordance with attached details or as specified in SWPPP.

Other Materials

- Wood stakes should be commercial quality lumber with nominal size of ¾" by ¾" and minimum length of 16 inches designed for the staking of compost socks and/or sediment retention fiber rolls (SRFRs). Each stake should be free from decay, splits or cracks longer than the thickness of the stake or other defects that would weaken the stakes and cause the stakes to be structurally unsuitable. Larger sized wood anchor stakes may be installed at the discretion of the installer, or as specified by the Project Engineer. Rebar or other metal rods are not recommended.
- Typical sock materials are; 1) high density polyethylene (HDPE) expandable, tubular, biodegradable or photodegradable, 2) polyester knitted mesh netting fabric sock, and 3) composite two-layered compost sock can be constructed using a polyester knitted mesh netting fabric sock as the outermost layer (outer filtration mesh) and a high density polyethylene (HDPE) expandable, tubular, biodegradable or photodegradable netting as the innermost layer (inner confinement netting). Sock materials shall be of sufficient diameter to allow the compost sock to be manufactured to the desired finished size. Aperture size (apparent opening of tubular net and knitted mesh netting) can range in size based on desired performance and intended function, but in no case shall outermost layer have an apparent size greater than 3/8".

Costs

Recently obtained Hawaii vendor cost indicated \$6.50 per linear foot for compost berm application and \$3.50 per linear foot for 10" (8.5" effective height) socks. Costs do not include final compost sock and berm functions at the end of construction activities, including spreading or removal, if required.

Inspection and Maintenance

- Inspect BMPs prior to forecasted rain, daily during extended rain events, after rain events 0.5" or greater which occurs in a 24-hour period, weekly during the rainy season, and at two-week intervals during the non-rainy season.
- Remove sediment which has accumulated to within 1/3 of the sock or berm height.
- Once damage is identified mend or reapply sock or berm as needed. Washed out areas should be replaced. If the sock or berm height is breached during a storm, an additional sock can be stacked to increase the sock height and similarly the berm dimensions can be increased, as applicable. An additional sock or berm may be installed upslope, as needed.
- Limit traffic to minimize damage to BMPs or impede vegetation establishment.

References

California Stormwater Quality Association (CASQA) Best Management Practices Handbook Construction, November 2009.

Hawaii Department of Transportation (HDOT) Best Management Practices Field Manual Construction, January 2008.

http://stormwaterhawaii.com/program_plan/pdfs/app_e6.pdf.

National Pollutant Discharge Elimination System (NPDES), Compost Filter Socks, U.S. Environmental Protection Agency (USEPA).

http://cfpub.epa.gov/npdes/stormwater/menuofbmps/index.cfm?action=factsheet_results&view=specific&bmp=120.

National Pollutant Discharge Elimination System (NPDES), Compost Filter Berms, U.S. Environmental Protection Agency (USEPA).

http://cfpub.epa.gov/npdes/stormwater/menuofbmps/index.cfm?action=factsheet_results&view=specific&bmp=119&minmeasure=4.

AASHTO. 2010 Standard Practice for Transportation Materials and Methods of Sampling and Testing, Designation R 51-10, Compost for Erosion/Sediment Control (Filter Berms and Filter Socks), American Association of State Highway Officials, Washington, D.C.

Faucette, et al. 2005. Evaluation of Stormwater from Compost and Conventional Erosion Control Practices in Construction Activities, *Journal of Soil and Water Conservation*, 60:6, 288-297.

USEPA. 1998. An Analysis of Composting as an Environmental Remediation Technology. U.S. Environmental Protection Agency, Solid Waste and Emergency Response (5305W), EPA530-R-98-008, April 1998.

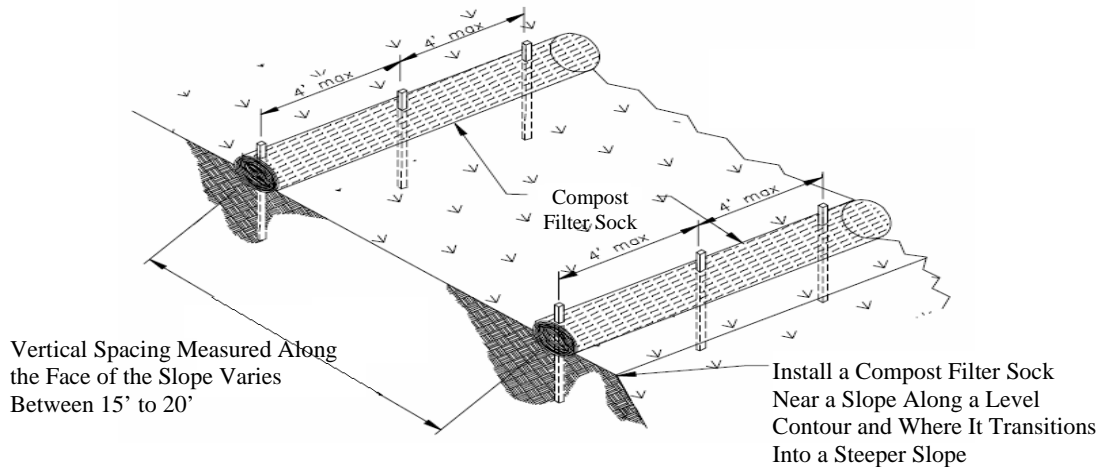

Detail "A"
Not to Scale

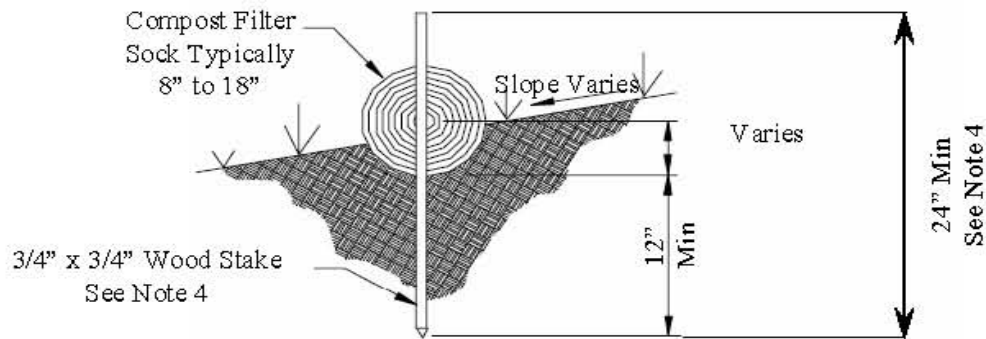

Section A-A
Not to Scale

Notes:

1. Compost Filter Socks should be either prefabricated or assembled at site.
2. Locate Compost Filter Socks on level contours spaced as follows:
 - a. Slope inclination of 4:1 (H:V) or flatter: Compost Filter Socks and/or berms should be placed at a maximum interval of 20 ft.
 - b. Slope inclination between 4:1 and 2:1 (H:V): Compost Filter Socks (use of berms not recommended) should be placed at a maximum interval of 15 ft. (a closer spacing is more effective).
 - c. Slope inclination of 2:1 (H:V) or greater: Compost Filter Socks should be placed at maximum interval of 10 ft.
3. Turn the ends of the Compost Filter Socks up slope to prevent runoff from going around the roll.
4. Stake Compost Filter Socks with stakes with a minimum length of 14 in and spaced 4 ft. on center.
5. If more than one Compost Filter Socks is placed in a row, the rolls should be overlapped, not abutted.

COMPOST FILTER SOCK (Slope Interruption Device)

SIDE VIEW

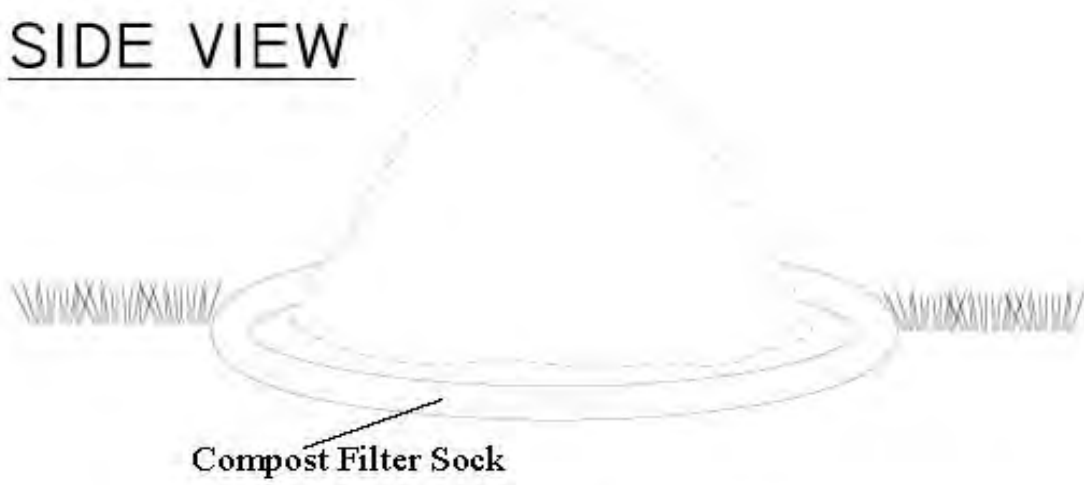

PLAN

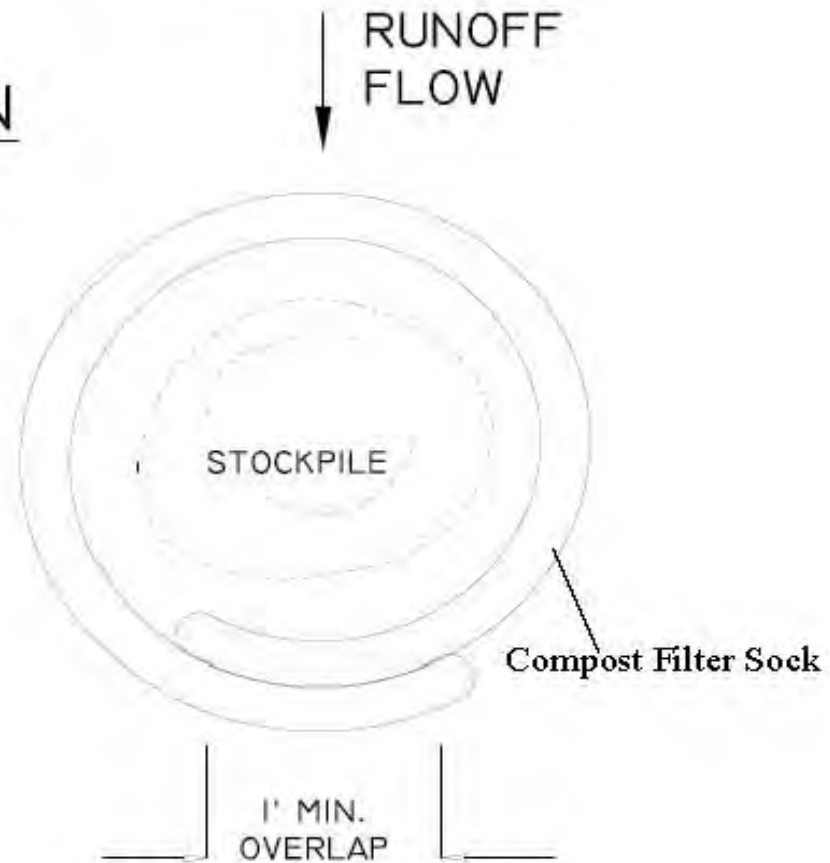

COMPOST FILTER SOCK (Stockpile Protection)

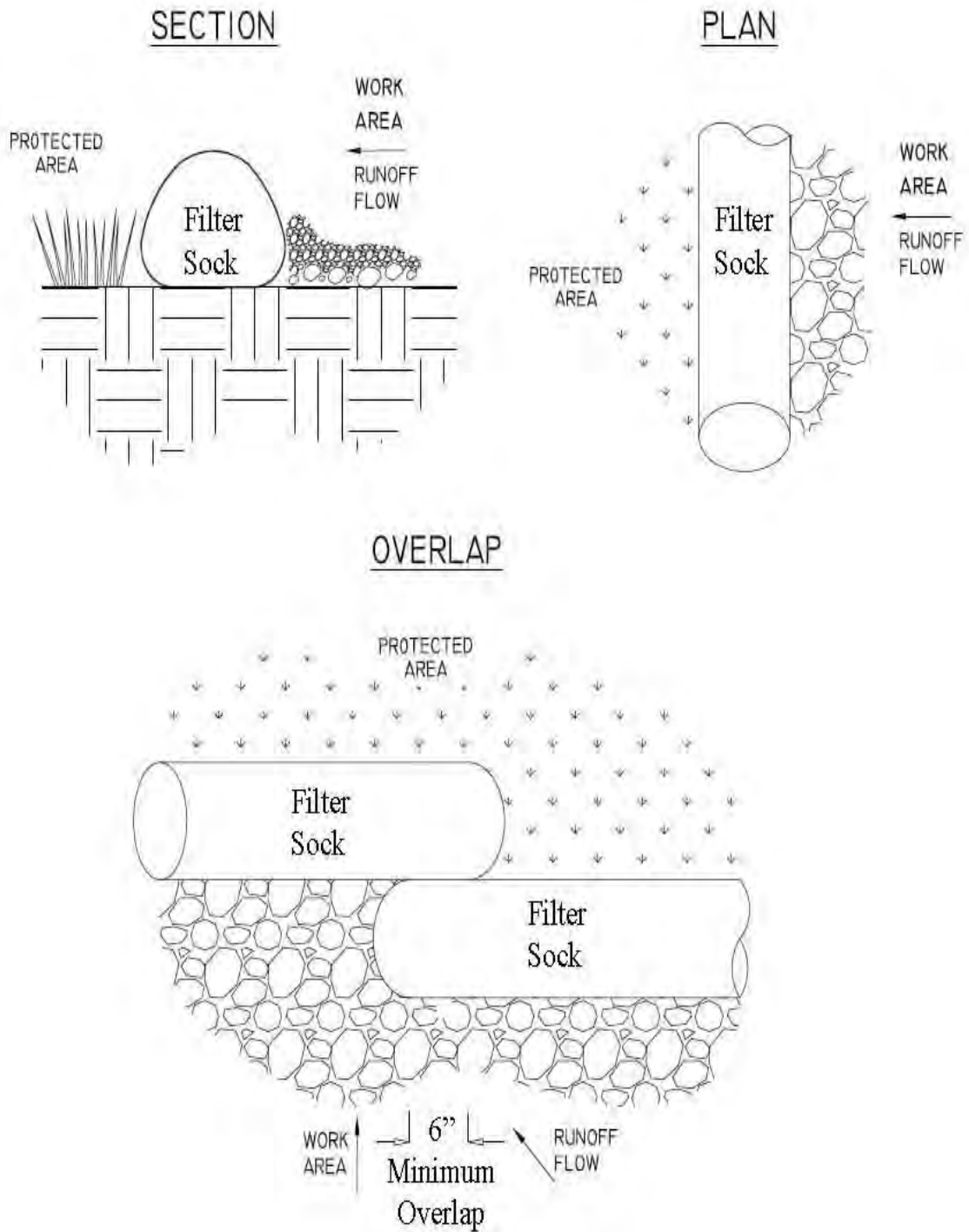

COMPOST FILTER SOCK (Perimeter Control)

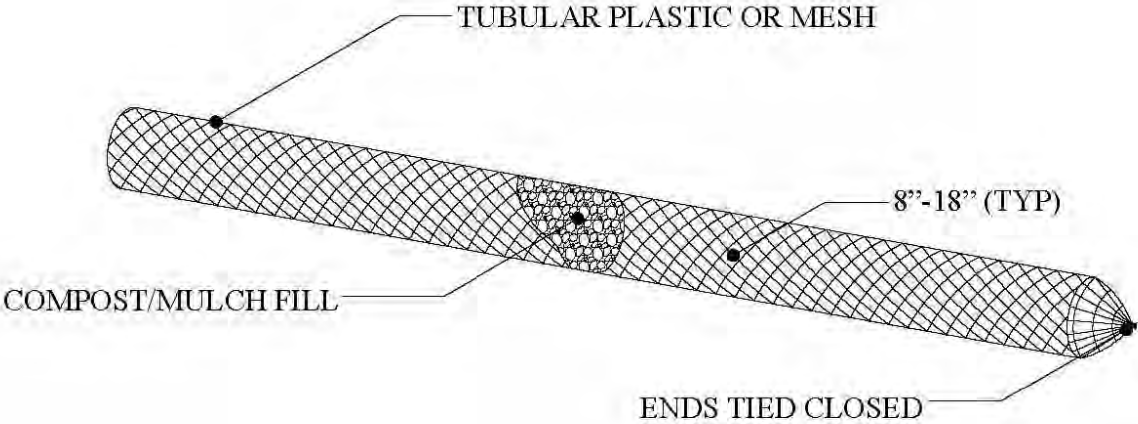

COMPOST FILTER SOCK

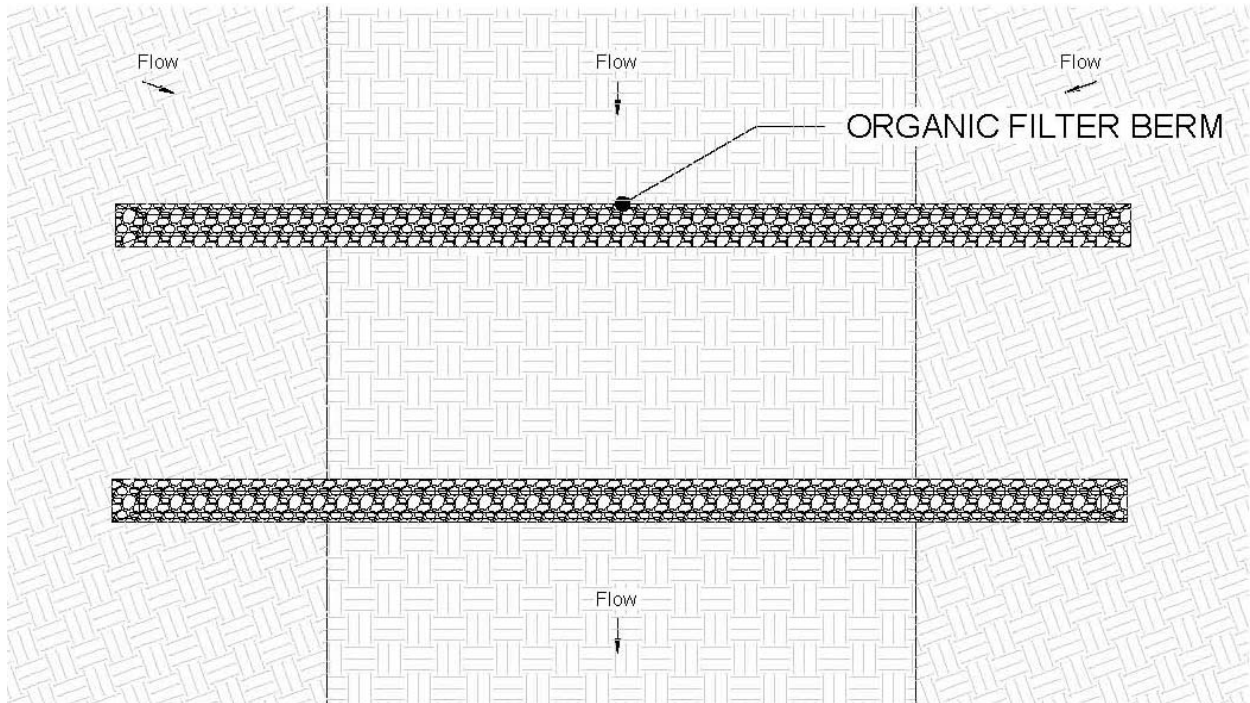

Plan "B"
Not to Scale

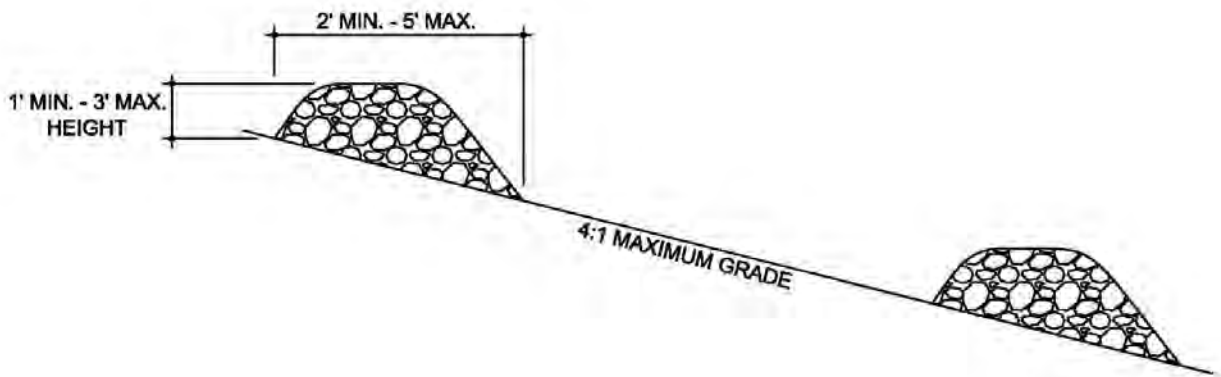

Section "B-B"
Not to Scale

COMPOST FILTER BERM

3.9 WIND EROSION CONTROL FACT SHEETS

WE-1 Wind Erosion Control



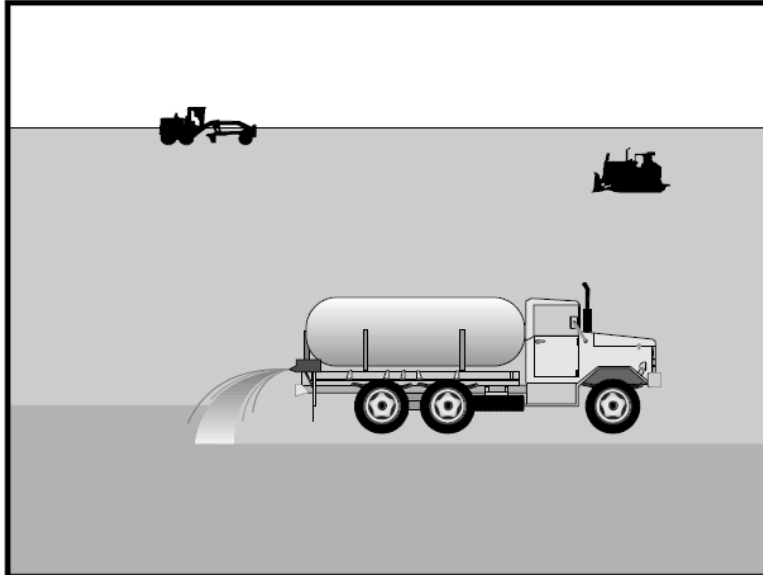

Description and Purpose

Wind erosion or dust control consists of applying water or other dust palliatives as necessary to prevent or alleviate dust nuisance generated by construction activities. Covering small stockpiles or areas is an alternative to applying water or other dust palliatives.

Suitable Applications

Wind erosion control BMPs are suitable during the following construction activities:

- Construction vehicle traffic on unpaved roads,
- Drilling and blasting activities,
- Sediment tracking onto paved roads,
- Soils and debris storage piles,
- Batch drop from front-end loaders,
- Areas with unstabilized soil, and/or
- Final grading/site stabilization.

Limitations

- Watering prevents dust only for a short period and should be applied daily (or more often) to be effective.
- Over watering may cause erosion.
- Oil or oil-treated subgrade should not be used for dust control because the oil may migrate into drainageways and/or seep into the soil.
- Effectiveness depends on soil, temperature, humidity, and wind velocity.

Objectives

- EC – Erosion Control
- SE – Sediment Control ▲
- TR – Tracking Control
- WE – Wind Erosion Control ✓
- NS – Non-Storm Water Management Control
- WM – Waste Management & Materials Pollution Control

Legend:

- ✓ Primary Objective
- ▲ Secondary Objective

Targeted Constituents

- Sediment ✓
- Nutrients
- Trash
- Metals
- Bacteria
- Oil and Grease
- Organics

Potential Alternatives

None

- Chemically treated subgrades may make the soil water repellent, interfering with long-term infiltration and the vegetation/re-vegetation of the site.
- Asphalt, as a mulch tack or chemical mulch, requires a 24-hour curing time to avoid adherence to equipment, worker shoes, etc. Application should be limited because asphalt surfacing may eventually migrate into the drainage system.
- In compacted areas, watering and other liquid dust control measures may wash sediment or other constituents into the drainage system.

Implementation

General

During these dry seasons, construction activities are at their peak, and disturbed and exposed areas are increasingly subject to wind erosion, sediment tracking and dust generated by construction equipment.

Dust control, as a BMP, is a practice that is already in place for many construction activities.

City and County of Honolulu has enacted dust control in the grading permit that cause dust to be transported beyond the construction project property line.

The following are measures that the City may have already implemented as requirements for dust control from contractors:

- Construction and Grading Permits: Require provisions for dust control (ROH Section 14-15.1 (k), 14-15.2 (e)).
- DOH NOI-C for projects greater than 1-acre. Site-specific BMPs Plan: Integrate dust control measures into the plan.

Dust Control Practices

Dust control BMPs generally stabilize exposed surfaces and minimize activities that suspend or track dust particles. The following table shows dust control practices that can be applied to site conditions that cause dust. For heavily traveled and disturbed areas, wet suppression (watering), chemical dust suppression, gravel asphalt surfacing, temporary gravel construction entrances, equipment wash-out areas, and haul truck covers can be employed as dust control applications. Permanent or temporary vegetation and mulching can be employed for areas of occasional or no construction traffic. Preventive measures would include minimizing surface areas to be disturbed, limiting onsite vehicle traffic to 15 mph, and controlling the number and activity of vehicles on a site at any given time.

Dust Control Practices

Site Condition	Permanent Vegetation	Mulching	Wet Suppression (Watering)	Chemical Dust Suppression	Gravel or Asphalt	Silt Fences	Temporary Gravel Construction Entrances/ Equipment Wash Down	Haul Truck Covers	Minimize Extent of Disturbed Area
Disturbed Areas not Subject to Traffic	x	x	x	x	x				x
Disturbed Areas Subjected to Traffic			x	x	x		x		x
Material Stock Pile Stabilization			x	x		x			x
Demolition			x				x	x	
Clearing/ Excavation			x	x		x			x
Truck Traffic on Unpaved Roads			x						
Mud/Dirt Carry Out					x		x		

Additional preventive measures include:

- Schedule construction activities to minimize exposed area (EC-2, Scheduling);
- Quickly stabilize exposed soils using vegetation, mulching, spray-on adhesives, calcium chloride, sprinkling, and stone/gravel layering;
- Identify and stabilize key access points prior to commencement of construction;
- Minimize the impact of dust by anticipating the direction of prevailing winds;
- Direct most construction traffic to stabilized roadways within the project site;
- Water should be applied by means of pressure-type distributors or pipelines equipped with a spray system or hoses and nozzles that will ensure even distribution;
- All distribution equipment should be equipped with a positive means of shutoff;
- Unless water is applied by means of pipelines, at least one mobile unit should be available at all times to apply water or dust palliative to the project;
- If reclaimed waste water is used, the sources and discharge must meet Hawaii Department of Health Wastewater Branch, Guidelines for the Treatment and Use of Recycled Water (2002) water reclamation criteria. Non-potable water should not be conveyed in tanks or drain pipes that will be used to convey potable water and there should be no connection between potable and non-potable supplies. Non-potable tanks, pipes, and other conveyances should be marked, "NON-POTABLE WATER - DO NOT DRINK.";

- Materials applied as temporary soil stabilizers and soil binders also generally provide wind erosion control benefits;
- Pave or chemically stabilize access points where unpaved traffic surfaces adjoin paved roads;
- Provide covers for haul trucks transporting materials that contribute to dust;
- Provide for wet suppression or chemical stabilization of exposed soils;
- Provide for rapid clean up of sediments deposited on paved roads. Furnish stabilized construction road entrances and vehicle wash down areas;
- Stabilize inactive construction sites using vegetation or chemical stabilization methods; and
- Limit the amount of areas disturbed by clearing and earth moving operations by scheduling these activities in phases.

For chemical stabilization, there are many products available for chemically stabilizing gravel roadways and stockpiles. If chemical stabilization is used, the chemicals should not create any adverse effects on storm water, plant life, or groundwater.

Costs

Installation costs for water and chemical dust suppression are low, but annual costs may be quite high since these measures are effective for only a few hours to a few days.

Inspection and Maintenance

- Inspect and verify that activity-based BMPs are in place prior to the commencement of associated activities. While activities associated with the BMP are under way, inspect weekly during the rainy season and at two-week intervals in the non-rainy season to verify continued BMP implementation.
- Check areas protected to ensure coverage.
- Most dust control measures require frequent, often daily, or multiple times per day attention.

References

Best Management Practices and Erosion Control Manual for Construction Sites, Flood Control District of Maricopa County, Arizona, September 1992.

California Air Pollution Control Laws, California Air Resources Board, 1992.

California Stormwater Quality Association (CASQA) Best Management Practices Handbook Construction, 2003.

Caltrans, Standard Specifications, Sections 10, "Dust Control"; Section 17, "Watering"; and Section 18, "Dust Palliative."

Hawaii Administrative Rules 11-60.1-33 Air Pollution Control.

Hawaii Department of Health Wastewater Branch, Guidelines for the Treatment and Use of Recycled Water, May 2002.

Prospects for Attaining the State Ambient Air Quality Standards for Suspended Particulate Matter (PM10), Visibility Reducing Particles, Sulfates, Lead, and Hydrogen Sulfide, California Air Resources Board, April 1991.

Revised Ordinances of Honolulu Article 15 Grading, Grubbing and Stockpiling.

Stormwater Quality Handbooks Construction Site Best Management Practices (BMPs) Manual, State of California Department of Transportation (Caltrans), November 2000.

Revised Ordinances of Honolulu Article 14 Permits, Bonds and Inspection for Grading, Soil Erosion and Sediment Control, 1990 as Amended.

3.10 TRACKING CONTROL FACT SHEETS

TR-1 Stabilized Construction Entrance/Exit

TR-2 Stabilized Construction Roadway

TR-3 Entrance/Outlet Tire Wash



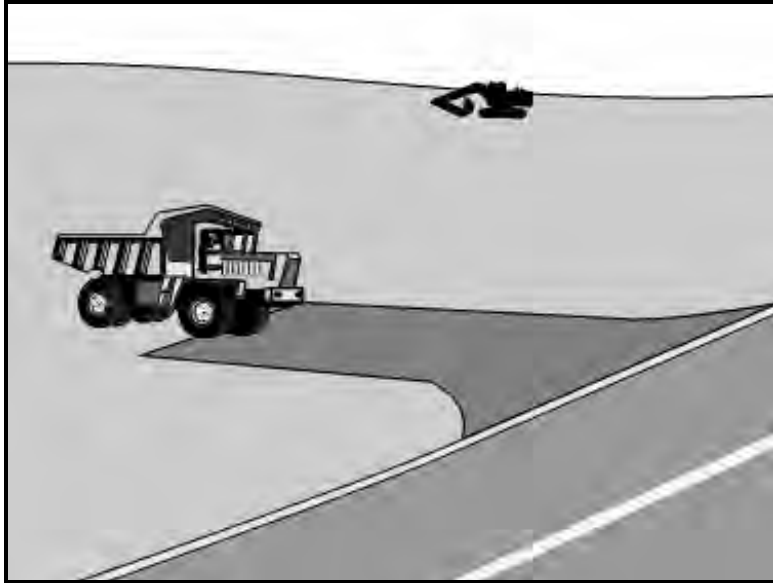

Description and Purpose

A stabilized construction access is defined by a point of entrance/exit to a construction site that is stabilized to reduce the tracking of mud and dirt onto public roads by construction vehicles.

Suitable Applications

Use at construction sites:

- Where dirt or mud can be tracked onto public roads,
- Adjacent to water bodies,
- Where poor soils are encountered, and/or
- Where dust is a problem during dry weather conditions.

Limitations

- Entrances and exits require periodic top dressing with additional stones.
- This BMP should be used in conjunction with street sweeping on adjacent public right of way.
- Entrances and exits should be constructed on level ground only.
- Stabilized construction entrances are rather expensive to construct and when a wash rack is included, a sediment trap of some kind must also be provided to collect wash water runoff.

Objectives

EC – Erosion Control	▲
SE – Sediment Control	▲
TR – Tracking Control	√
WE – Wind Erosion Control	
NS – Non-Storm Water Management Control	
WM – Waste Management & Materials Pollution Control	

Legend:

- √ Primary Objective
- ▲ Secondary Objective

Targeted Constituents

Sediment	√
Nutrients	
Trash	
Metals	
Bacteria	
Oil and Grease	
Organics	

Potential Alternatives

None

Implementation

General

A stabilized construction entrance is a pad of aggregate underlain with filter cloth located at any point where traffic will be entering or leaving a construction site to or from a public right of way, street, alley, sidewalk, or parking area. The purpose of a stabilized construction entrance is to reduce or eliminate the tracking of sediment onto public rights of way or streets. Reducing tracking of sediments and other pollutants onto paved roads helps prevent deposition of sediments into local storm drains and production of airborne dust.

Where traffic will be entering or leaving the construction site, a stabilized construction entrance should be used. NPDES permits require that appropriate measures be implemented to prevent tracking of sediments onto paved roadways, where a significant source of sediments is derived from mud and dirt carried out from unpaved roads and construction sites.

Stabilized construction entrances are moderately effective in removing sediment from equipment leaving a construction site. The entrance should be built on level ground. Advantages of the Stabilized Construction Entrance/Exit are that it does remove some sediment from equipment and serves to channel construction traffic in and out of the site at specified locations. Efficiency is greatly increased when a washing rack is included as part of a stabilized construction entrance/exit.

See the City and County of Honolulu's "Rules Relating to Soil Erosion Standards and Guidelines," for additional information.

Design and Layout

- Construct on level ground where possible.
- Select 3 to 6 in. diameter stones.
- Use minimum depth of stones of 12 in. or as recommended by soils engineer.
- Construct length of 50 ft. minimum, and 30 ft. minimum width.
- Rumble racks constructed of steel panels with ridges and installed in the stabilized entrance/exit will help remove additional sediment and to keep adjacent streets clean.
- Provide ample turning radii as part of the entrance.
- Limit the points of entrance/exit to the construction site.
- Limit speed of vehicles to control dust.
- Properly grade each construction entrance/exit to prevent runoff from leaving the construction site.
- Route runoff from stabilized entrances/exits through a sediment trapping device before discharge.
- Design stabilized entrance/exit to support heaviest vehicles and equipment that will use it.
- Select construction access stabilization (aggregate, asphaltic concrete, concrete) based on longevity, required performance, and site conditions. Do not use asphalt concrete (AC) grindings for stabilized construction access/roadway.

- If aggregate is selected, place crushed aggregate over geotextile fabric to at least 12 in. depth, or place aggregate to a depth recommended by a geotechnical engineer. A crushed aggregate greater than 3 in. but not exceeding 6 in. should be used.
- Designate combination or single purpose entrances and exits to the construction site.
- Require that all employees, subcontractors, and suppliers utilize the stabilized construction access.
- Implement SE-7, Street Sweeping and Vacuuming, as needed.
- All exit locations intended to be used for more than a two-week period should have stabilized construction entrance/exit BMPs.

Inspection and Maintenance

- Inspect and verify that activity-based BMPs are in place prior to the commencement of associated activities. While activities associated with the BMPs are under way, inspect weekly during the rainy season and of two-week intervals in the non-rainy season to verify continued BMP implementation.
- Inspect local roads adjacent to the site daily. Sweep or vacuum to remove visible accumulated sediment.
- Remove aggregate, separate and dispose of sediment if construction entrance/exit is clogged with sediment.
- Keep all temporary roadway ditches clear.
- Check for damage and repair as needed.
- Replace gravel material when surface voids are visible.
- Remove all sediment deposited on paved roadways within 24 hours.
- Remove gravel and filter fabric at completion of construction.

Costs

In California, average annual cost for installation and maintenance may vary from \$1,200 to \$4,800 each, averaging \$2,400 per entrance. Costs will increase with addition of washing rack, and sediment trap. With wash rack, costs range from \$1,200 - \$6,000 each, averaging \$3,600 per entrance. Note that Hawaii's unit prices are higher than California's unit prices.

References

California Stormwater Quality Association (CASQA) Best Management Practices Handbook Construction, 2003.

Guidance Specifying Management Measures for Nonpoint Pollution in Coastal Waters, EPA 840-B-9-002, USEPA, Office of Water, Washington, DC, 1993.

Manual of Standards of Erosion and Sediment Control Measures, Association of Bay Area Governments, May 1995.

National Management Measures to Control Nonpoint Source Pollution from Urban Areas, USEPA Agency, 2002.

Proposed Guidance Specifying Management Measures for Sources of Nonpoint Pollution in Coastal Waters, Work Group Working Paper, USEPA, April 1992.

Stormwater Management of the Puget Sound Basin, Technical Manual, Publication #91-75, Washington State Department of Ecology, February 1992.

Stormwater Quality Handbooks Construction Site Best Management Practices (BMPs) Manual, State of California Department of Transportation (Caltrans), November 2000.

Virginia Erosion and Sedimentation Control Handbook, Virginia Department of Conservation and Recreation, Division of Soil and Water Conservation, 1991.

Water Quality Management Plan for the Lake Tahoe Region, Volume II, Handbook of Management Practices, Tahoe Regional Planning Agency, November 1988.

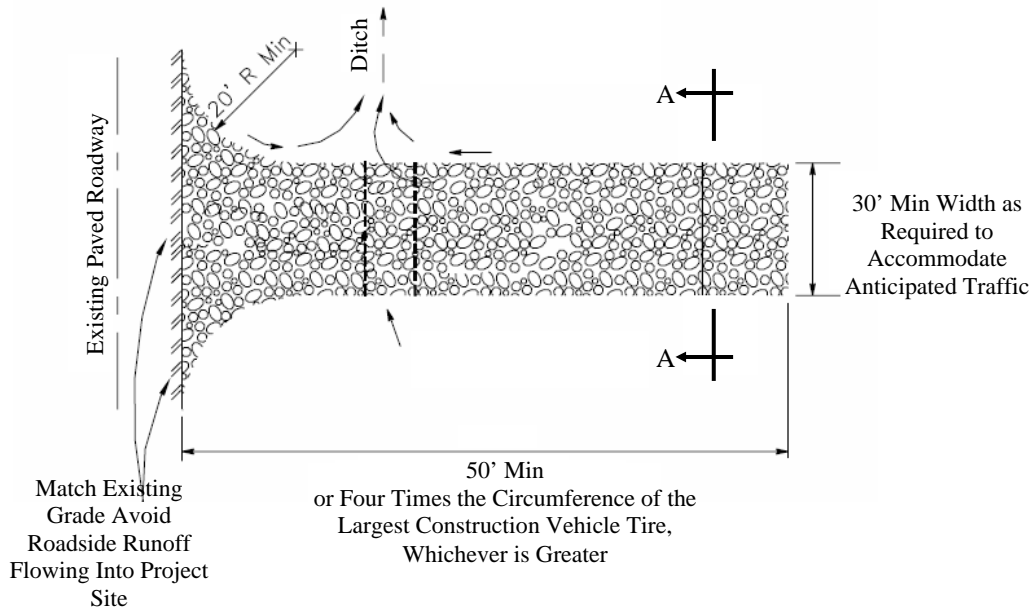

Detail "A"
Not to Scale

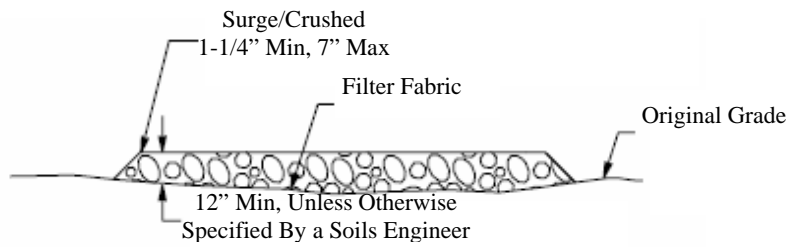

Section A-A
Not to Scale

Stabilized Construction Entrance/Exit

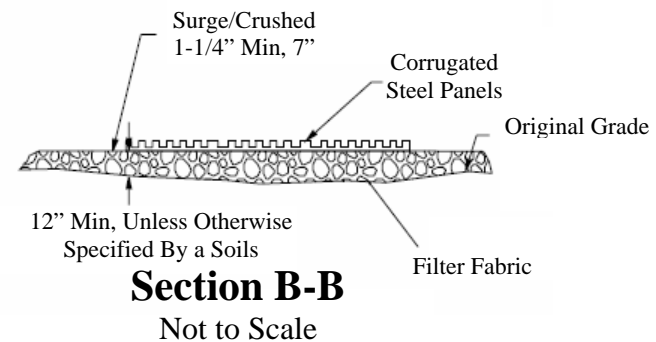
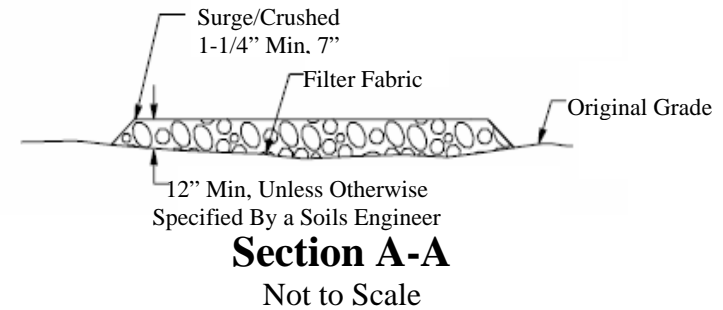
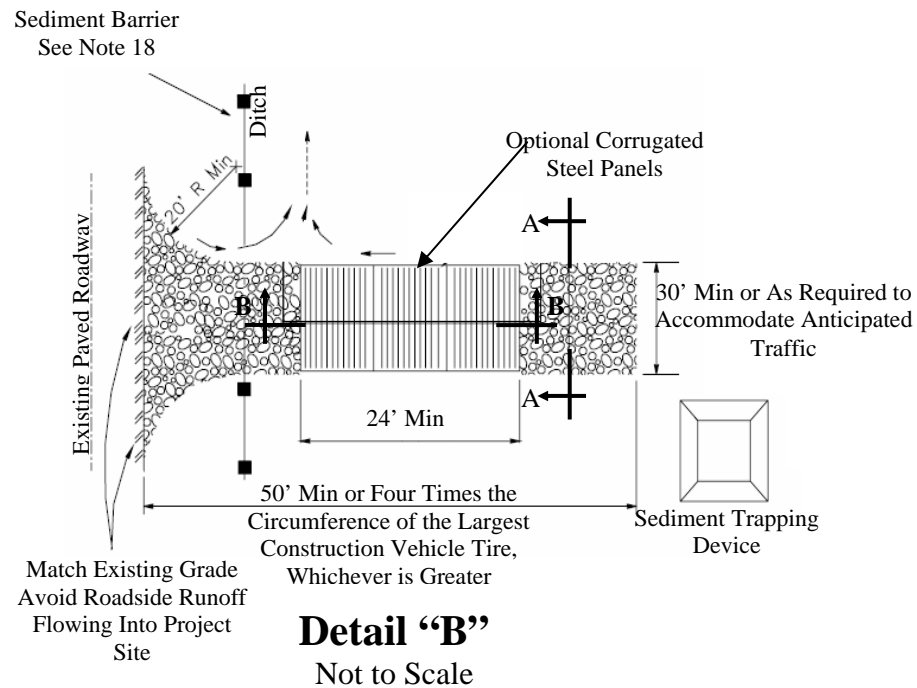

Notes:

1. Construct on level ground where possible.
2. Select 3 to 6 in. diameter stones.
3. Use minimum depth of stones of 12 in. or as recommended by soils engineer.
4. Construct length of 50 ft. minimum, and 30 ft. minimum width.
5. Rumble racks constructed of steel panels with ridges and installed in the stabilized entrance/exit will help remove additional sediment and to keep adjacent streets clean.
6. Provide ample turning radii as part of the entrance.
7. Limit the points of entrance/exit to the construction site.
8. Limit speed of vehicles to control dust.
9. Properly grade each construction entrance/exit to prevent runoff from leaving the construction site.
10. Route runoff from stabilized entrances/exits through a sediment trapping device before discharge.
11. Design stabilized entrance/exit to support heaviest vehicles and equipment that will use it.
12. Select construction access stabilization (aggregate, asphaltic concrete, concrete) based on longevity, required performance, and site conditions. Do not use asphalt concrete (AC) grindings for stabilized construction access/roadway.
13. Place crushed aggregate over geotextile fabric to at least 12 in. depth, or place aggregate to a depth recommended by a geotechnical engineer. A crushed aggregate greater than 3 in. but not exceeding 6 in. should be used.
14. Designate combination or single purpose entrances and exits to the construction site.
15. Require that all employees, subcontractors, and suppliers utilize the stabilized construction access.
16. Implement SE-7, Street Sweeping and Vacuuming, as needed.
17. All exit locations intended to be used for more than a two-week period should have stabilized construction entrance/exit BMPs.
18. Construct sediment Barrier and channel runoff to sediment trapping device as appropriate.

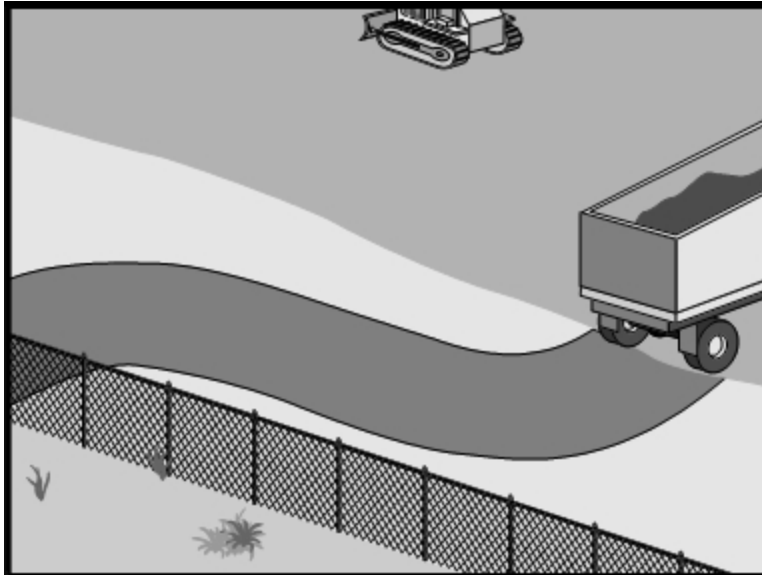

Description and Purpose

Access roads, subdivision roads, parking areas, and other onsite vehicle transportation routes should be stabilized immediately after grading, and frequently maintained to prevent erosion and control dust.

Suitable Applications

This BMP should be applied for the following conditions:

- Temporary Construction Traffic:
 - Phased construction projects and offsite road access, or
 - Construction during wet weather.
- Construction roadways and detour roads:
 - Where mud tracking is a problem during wet weather,
 - Where dust is a problem during dry weather,
 - Adjacent to water bodies, or
 - Where poor soils are encountered.

Limitations

- The roadway must be removed or paved when construction is complete.
- Certain chemical stabilization methods may cause storm water or soil pollution and should not be used. See WE-1, Wind Erosion Control.
- Management of construction traffic is subject to air quality control measures. Contact the local air quality management agency.

Objectives

EC – Erosion Control	▲
SE – Sediment Control	▲
TR – Tracking Control	√
WE – Wind Erosion Control	
NS – Non-Storm Water Management Control	
WM – Waste Management & Materials Pollution Control	

Legend:

- √ Primary Objective
- ▲ Secondary Objective

Targeted Constituents

Sediment	√
Nutrients	
Trash	
Metals	
Bacteria	
Oil and Grease	
Organics	

Potential Alternatives

None

- Materials will likely need to be removed prior to final project grading and stabilization.
- Use of this BMP may not be applicable to very short duration projects.

Implementation

General

Areas that are graded for construction vehicle transport and parking purposes are especially susceptible to erosion and dust. The exposed soil surface is continually disturbed, leaving no opportunity for vegetative stabilization. Such areas also tend to collect and transport runoff waters along their surfaces. During wet weather, they often become muddy quagmires that generate significant quantities of sediment that may pollute nearby streams or are transported offsite on the wheels of construction vehicles. Dirt roads can become so unstable during wet weather that they are virtually unusable.

Efficient construction road stabilization not only reduces onsite erosion but also can significantly speed onsite work, avoid instances of immobilized machinery and delivery vehicles, and generally improve site efficiency and working conditions during adverse weather.

Installation/Application Criteria

Permanent roads and parking areas should be paved as soon as possible after grading. As an alternative where construction will be phased, the early application of gravel or chemical stabilization may solve potential erosion and stability problems. Temporary gravel roadway should be considered during the rainy season and on slopes greater than 5%.

Temporary roads should follow the contour of the natural terrain to the maximum extent possible. Slope should not exceed 15%. Roadways should be carefully graded to drain transversely. Provide drainage swales on each side of the roadway in the case of a crowned section or one side in the case of a super elevated section. Simple gravel berms without a trench can also be used.

Installed inlets should be protected to prevent sediment laden water from entering the storm sewer system (SE-9, Storm Drain Inlet Protection). In addition, the following criteria should be considered.

- Road should follow topographic contours to reduce erosion of the roadway.
- The roadway slope should not exceed 15%.
- Chemical stabilizers or water are usually required on gravel or dirt roads to prevent dust (WE-1, Wind Erosion Control).
- Properly grade roadway to prevent runoff from leaving the construction site.
- Design stabilized access to support heaviest vehicles and equipment that will use it.
- Stabilize roadway using aggregate, asphalt concrete, or concrete based on longevity, required performance, and site conditions. The use of cold mix asphalt or asphalt concrete (AC) grindings for stabilized construction roadway is not allowed.
- Coordinate materials with those used for stabilized construction entrance/exit points.
- If aggregate is selected, place crushed aggregate over geotextile fabric to at least 12 in. depth. A crushed aggregate greater than 3 in. but smaller than 6 in. should be used.

Inspection and Maintenance

- Inspect and verify that activity-based BMPs are in place prior to the commencement of associated activities. While activities associated with the BMP are under way, inspect weekly during the rainy season and of two-week intervals in the non-rainy season to verify continued BMP implementation.
- Keep all temporary roadway ditches clear.
- When no longer required, remove stabilized construction roadway and re-grade and repair slopes.
- Periodically apply additional aggregate on gravel roads.
- Active dirt construction roads are commonly watered three or more times per day during the dry season.

Costs

Gravel construction roads are moderately expensive, but cost is often balanced by reductions in construction delay. No additional costs for dust control on construction roads should be required above that needed to meet local air quality requirements.

References

Blueprint for a Clean Bay: Best Management Practices to Prevent Stormwater Pollution from Construction Related Activities; Santa Clara Valley Nonpoint Source Pollution Control Program, 1995.

California Stormwater Quality Association (CASQA) Best Management Practices Handbook Construction, 2003.

Coastal Nonpoint Pollution Control Program; Program Development and Approval Guidance, Working Group, Working Paper; USEPA, April 1992.

Manual of Standards of Erosion and Sediment Control Measures, Association of Bay Area Governments, May 1995.

Stormwater Management for Construction Activities, Developing Pollution Prevention Plans and Best Management Practices, EPA 832-R-92005; USEPA, April 1992.

Stormwater Management of the Puget Sound Basin, Technical Manual, Publication #91-75, Washington State Department of Ecology, February 1992.

Stormwater Quality Handbooks Construction Site Best Management Practices (BMPs) Manual, State of California Department of Transportation (Caltrans), November 2000.

Virginia Erosion and Sedimentation Control Handbook, Virginia Department of Conservation and Recreation, Division of Soil and Water Conservation, 1991.

Water Quality Management Plan for the Lake Tahoe Region, Volume II, Handbook of Management Practices, Tahoe Regional Planning Agency, November 1988.

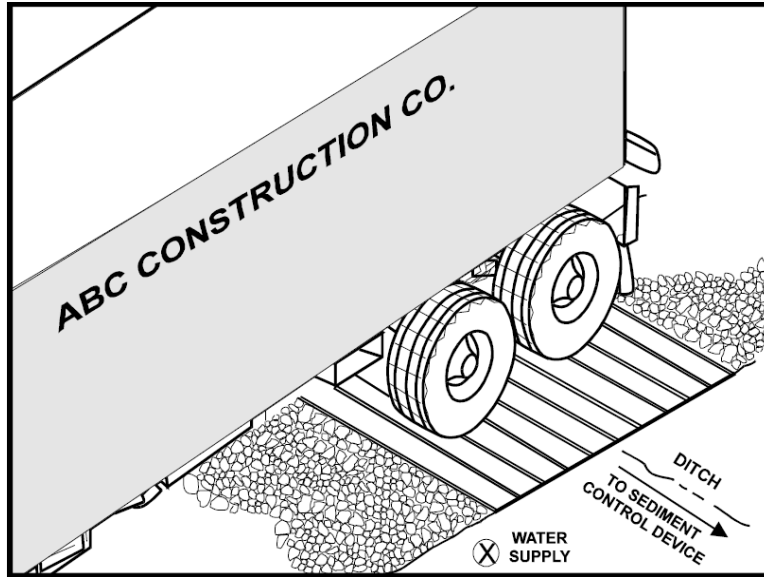

Description and Purpose

A tire wash is an area located at stabilized construction access points to remove sediment from tires and under carriages and to prevent sediment from being transported onto public roadways.

Suitable Applications

Tire washes may be used on construction sites where dirt and mud tracking onto public roads by construction vehicles may occur.

Soil erosion control designer to exercise professional judgment on its application to a project.

Limitations

- The tire wash requires a supply of wash water.
- A turnout or doublewide exit is required to avoid having entering vehicles drive through the wash area.
- Do not use where wet tire trucks leaving the site leave the road dangerously slick.

Implementation

- Incorporate with a stabilized construction entrance/exit. See TR-1, Stabilized Construction Entrance/Exit.
- Construct on level ground when possible, on a pad of coarse aggregate greater than 3 in. but not exceeding 6 in. A geotextile fabric should be placed below the aggregate.
- Wash rack should be designed and constructed/manufactured for anticipated traffic loads.

Objectives

- EC – Erosion Control
- SE – Sediment Control ▲
- TR – Tracking Control ✓
- WE – Wind Erosion Control
- NS – Non-Storm Water Management Control
- WM – Waste Management & Materials Pollution Control

Legend:

- ✓ Primary Objective
- ▲ Secondary Objective

Targeted Constituents

- Sediment ✓
- Nutrients
- Trash
- Metals
- Bacteria
- Oil and Grease
- Organics

Potential Alternatives

- TR-1 Stabilized Construction Entrance/Exit

- Provide a drainage ditch that will convey the runoff from the wash area to a sediment trapping device sized for the anticipated amount of vehicle washing and rainfall. The drainage ditch should be of sufficient grade, width, and depth to carry the wash runoff.
- Use hoses with automatic shutoff nozzles to prevent hoses from being left on.
- Require that all employees, subcontractors, and others that leave the site with mud caked tires and undercarriages to use the wash facility.
- Implement SE-7, Street Sweeping and Vacuuming, as needed.

Costs

Costs are low for installation of wash rack.

Inspection and Maintenance

- Inspect and verify that activity-based BMPs are in place prior to the commencement of associated activities. While activities associated with the BMP are under way, inspect weekly during the rainy season and of two-week intervals in the non-rainy season to verify continued BMP implementation.
- Inspect BMPs subject to non-storm water discharge daily while non-storm water discharges occur.
- Remove accumulated sediment in wash rack and/or sediment trap to maintain system performance.
- Inspect routinely for damage and repair as needed.

References

Blueprint for a Clean Bay: Best Management Practices to Prevent Stormwater Pollution from Construction Related Activities; Santa Clara Valley Nonpoint Source Pollution Control Program, 1995.

California Stormwater Quality Association (CASQA) Best Management Practices Handbook Construction, 2003.

Coastal Nonpoint Pollution Control Program; Program Development and Approval Guidance, Working Group, Working Paper; USEPA, April 1992.

Manual of Standards of Erosion and Sediment Control Measures, Association of Bay Area Governments, May 1995.

Stormwater Management for Construction Activities, Developing Pollution Prevention Plans and Best Management Practices, EPA 832-R-92005; USEPA, April 1992.

Stormwater Quality Handbooks Construction Site Best Management Practices (BMPs) Manual, State of California Department of Transportation (Caltrans), November 2000.

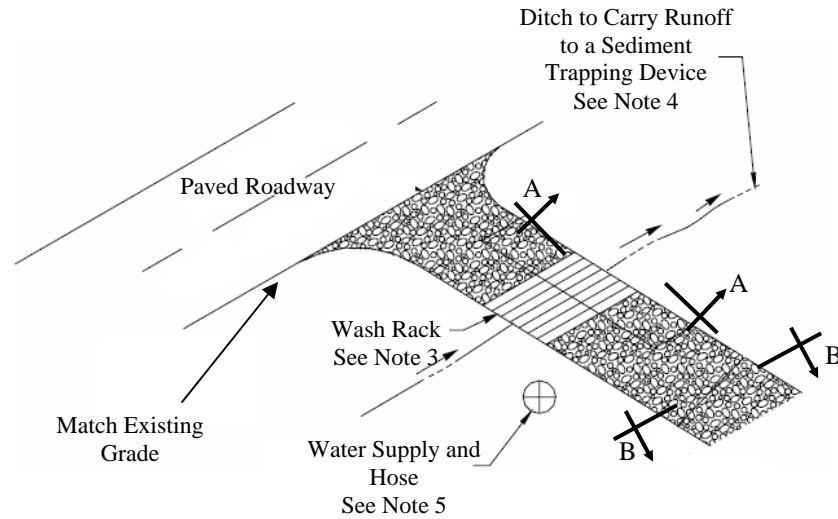

Plan "A"
Not to Scale

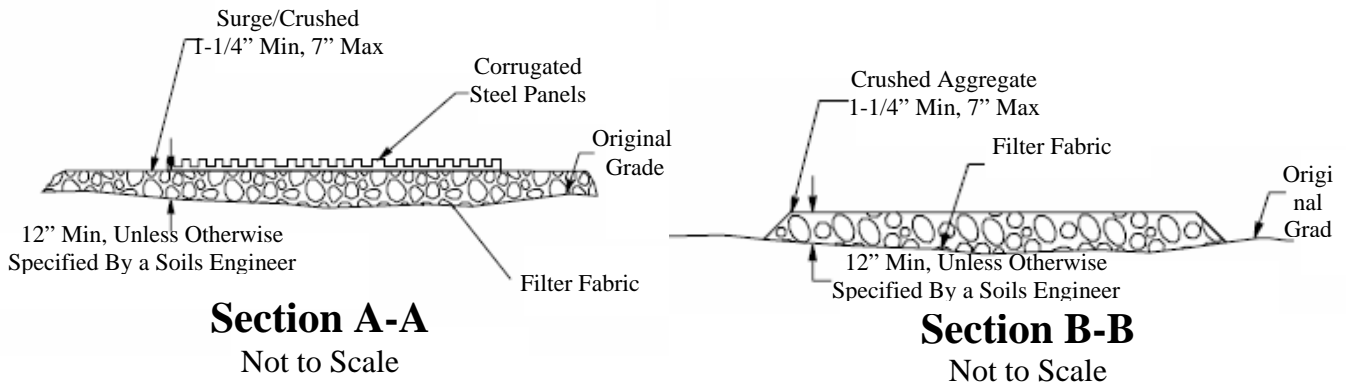

Section A-A
Not to Scale

Section B-B
Not to Scale

Notes:

1. Incorporate with a stabilized construction entrance/exit. See TC-1, Stabilized Construction Entrance/Exit.
2. Construct on level ground when possible, on a pad of coarse aggregate greater than 3 in. but not exceeding 6 in. A geotextile fabric should be placed below the aggregate.
3. Wash rack should be designed and constructed/manufactured for anticipated traffic loads.
4. Provide a drainage ditch that will convey the runoff from the wash area to a sediment trapping device sized for the anticipated amount of vehicle washing and rainfall. The drainage ditch should be of sufficient grade, width, and depth to carry the wash runoff.
5. Use hoses with automatic shutoff nozzles to prevent hoses from being left on.
6. Require that all employees, subcontractors, and others that leave the site with mud caked tires and undercarriages to use the wash facility.
7. Implement SE-7, Street Sweeping and Vacuuming, as needed.

Typical Tire Wash

SECTION 4: NON-STORM WATER MANAGEMENT AND MATERIAL MANAGEMENT BMPS

4.1 NON-STORM WATER MANAGEMENT BMPS

The construction general permit prohibits the discharge of materials other than storm water and authorized non-storm water discharges. It is recognized that certain non-storm water discharges may be necessary for the completion of construction projects. Such discharges include but are not limited to irrigation of vegetative erosion control measures, pipe flushing and testing, and street cleaning.

Non-storm water management BMPS are source control BMPS that prevent pollution by limiting or reducing potential pollutants at their source or eliminating off-site discharge. These practices involve day-to-day operations of the construction site and are usually under the control of the contractor. These BMPS are also referred to as “good housekeeping practices” which involve keeping a clean, orderly construction site.

Non-storm water management BMPS also include procedures and practices designed to minimize or eliminate the discharge of pollutants from vehicle and equipment cleaning, fueling, and maintenance operations to storm water drainage systems or to watercourses.

Table 4-1 lists the non-storm water management BMPS. All these BMPS should be implemented depending on the conditions and applicability of deployment described as part of the BMP.

It is recommended that owners and contractors be vigilant regarding implementation of these BMPS, including making their implementation a condition of continued employment, and part of all prime and subcontract agreements. By doing so, the chance of inadvertent violation by an uncaring individual can be prevented, potentially saving thousands of dollars in fines and project delays. Also, if procedures are not properly implemented and/or if BMPS are compromised then the discharge is subject to sampling and analysis requirements contained in the general permit.

Table 4-1: Non-Storm Water Management BMP

BMP#	BMP Name
NS-1	Water Conservation Practices
NS-2	Dewatering Operations
NS-3	Paving and Grinding Operations
NS-4	Temporary Stream Crossing
NS-5	Clear Water Diversion
NS-6	Illicit Connection/Discharge
NS-7	Potable Water/Irrigation
NS-8	Vehicle and Equipment Cleaning
NS-9	Vehicle and Equipment Fueling
NS-10	Vehicle and Equipment Maintenance
NS-11	Pile Driving Operations
NS-12	Concrete Curing
NS-13	Concrete Finishing
NS-14	Material over Water
NS-15	Demolition Adjacent to Water
NS-16	Temporary Batch Plants

4.2 WASTE MANAGEMENT & MATERIALS POLLUTION CONTROL BMPs

Waste management and materials pollution control BMPs, like non-storm water management BMPs, are source control BMPs that prevent pollution by limiting or reducing potential pollutants at their source before they come in contact with storm water. These BMPs also involve day-to-day operations of the construction site, are under the control of the contractor, and are additional “good housekeeping practices” which involve keeping a clean, orderly construction site.

Waste management consists of implementing procedural and structural BMPs for handling, storing, and disposing of wastes generated by a construction project. The objective is to prevent the release of waste materials into storm water runoff or discharges through proper management of the following types of wastes:

- Solid,
- Sanitary,
- Concrete,
- Hazardous, and
- Equipment – related wastes.

Materials pollution control (also called materials handling) consists of implementing procedural and structural BMPs in the handling, storing, and the use of construction materials. The BMPs are intended to prevent the release of pollutants during storm water and non-storm water discharges. The objective is to prevent or reduce the opportunity for contamination of storm water runoff from construction materials by covering and/or providing secondary containment of storage areas, and by taking adequate precautions when handling materials. These controls must be implemented for all applicable activities, material usage, and site conditions.

Table 4-2 lists the waste management and materials pollution control BMPs. It is important to note that these BMPs should be implemented depending on the conditions/applicability of deployment described as part of the BMP.

Table 4-2: Waste Management & Materials Pollution Control BMP

BMP#	BMP Name
WM-1	Material Delivery and Storage
WM-2	Material Use
WM-3	Stockpile Management
WM-4	Spill Prevention and Control
WM-5	Solid Waste Management
WM-6	Hazardous Waste Management
WM-7	Contaminated Soil Management
WM-8	Concrete Waste Management
WM-9	Sanitary/Septic Waste Management
WM-10	Liquid Waste Management

Table 4-3 Quick Reference - Disposal Alternatives lists general discharge/activities and suggests disposal methods as well as any necessary approval.

4.3 FACT SHEET FORMAT

The BMP face sheet is a short document that gives all the information about a particular BMP. Typically, each fact sheet contains the information outlined in Figure 4-1. Completed fact sheets for each of the above activities are provided in Section 4.4.

Figure 4-1: Example of Fact Sheet

NS-xx-Example of Fact Sheet
<u>Description and Purpose</u>
<u>Suitable Applications</u>
<u>Limitations</u>
<u>Implementation</u>
<u>Cost</u>
<u>Inspection and Maintenance</u>

The fact sheets also contain side bar presentations with information on BMP objectives, targeted constituents, removal effectiveness, and potential alternatives.

4.4 BMP FACT SHEETS

BMP Fact Sheets for non-storm water management and waste management and materials pollution control follow. The BMP fact sheets are individually page numbered and are suitable for photocopying and inclusion into SSBMPPs.

Table 4-3: Quick Reference – Disposal Alternatives

(Adopted from Santa Clara County Nonpoint Source Pollution Control Program - December, 1992)

All of the waste products on this chart are prohibited from discharge to the storm drain system. Use this matrix to decide which alternative disposal strategies to use.

ALTERNATIVES ARE LISTED IN PRIORITY ORDER

KEY:

POTW - Publicly Owned Treatment Plant, which in most areas is the City & County of Honolulu, Department of Environmental Services.

“Dispose to sanitary sewer” means dispose into sink, toilet, or sanitary sewer clean-out connection.

“Dispose as trash” means dispose in dumpsters or trash containers for pickup and/or eventual disposal in landfill.

“Dispose as hazardous waste” for business/commercial means contract with a hazardous waste hauler to remove and dispose.

Table 4-3: Quick Reference – Disposal Alternatives (Cont'd)

Discharge/Activity	Business/Commercial	
	Disposal	Approval
<i>General Construction and Painting, Street and Utility Maintenance</i>		
Excess Paint (oil- based)	<ul style="list-style-type: none"> ▪ Recycle/reuse. ▪ If volume is too much to dry, solidify with absorbent material, dispose as solid waste. 	
Excess Paint (water-based)	<ul style="list-style-type: none"> ▪ Recycle/reuse. ▪ Dry by leaving cans in open air, dispose as solid waste. ▪ If volume is too much to dry, solidify with absorbent material, dispose as solid waste. 	
Paint cleanup (oil-based)	<ul style="list-style-type: none"> ▪ Wipe paint out of brushes, then: <ul style="list-style-type: none"> • Filter & reuse thinners, solvents; and • Dispose as hazardous waste. 	
Paint cleanup (water-based)	<ul style="list-style-type: none"> ▪ Wipe paint out of brushes, then: <ul style="list-style-type: none"> • Rinse to sanitary sewer. 	
Empty paint cans (dry) (See WM-5)	<ul style="list-style-type: none"> ▪ Remove lids, dispose as solid waste. 	
Paint Stripping (with solvent)	<ul style="list-style-type: none"> ▪ Use it up/give it to someone to use for original intended purpose. ▪ Separate from non-hazardous wastes (to prevent commingling with recyclable materials). ▪ Dispose as hazardous waste. 	
Building exterior cleaning (high pressure water)	<ul style="list-style-type: none"> ▪ Prevent entry into storm drain and remove offsite. ▪ Wash onto dirt area, spade in. ▪ Collect (e.g. mop up) and discharge to sanitary sewer. 	POTW
Cleaning of building exteriors which have HAZARDOUS MATERIALS (e.g. mercury, lead) in paints (See WM-6)	<ul style="list-style-type: none"> ▪ Use dry clean methods. ▪ Contain and dispose washwater as hazardous waste (suggestion: dry material first to reduce volume). 	Site permitted to handle HW [#] [#] Corrected 05/23/2012
Non-hazardous paint scraping/sand blasting (See WM-6)	<ul style="list-style-type: none"> ▪ Dry sweep, dispose as solid waste. 	MSW Landfill [#]

Discharge/Activity	Business/Commercial	
	Disposal	Approval
HAZARDOUS paint scraping/sand blasting (e.g. marine paints or paints containing lead or tributyl tin)	<ul style="list-style-type: none"> ▪ Dry sweep, dispose as hazardous waste. 	
Cleaning streets in construction areas	<ul style="list-style-type: none"> ▪ Dry sweep and minimize tracking of mud, then wash street with water, filter prior to discharging to storm drain. ▪ Use silt ponds, gravel filters, and/or similar pollutant reduction techniques when flushing pavement. 	
Fresh cement, grout, mortar (See WM-8)	<ul style="list-style-type: none"> ▪ Use/reuse excess for original intended purpose. ▪ Dispose separately from recyclable materials as solid waste (take to C&D Landfill.) 	C&D Landfill
Washwater from concrete/motor (etc.) cleanup	<ul style="list-style-type: none"> ▪ Wash onto dirt area, spade in. ▪ Pump and remove to appropriate disposal facility. ▪ Settle, pump water to sanitary sewer. 	
Aggregate wash from driveway/patio construction	<ul style="list-style-type: none"> ▪ Wash onto dirt area, spade in. ▪ Pump and remove to appropriate disposal facility. ▪ Settle, pump water to sanitary sewer. 	POTW
Rinsewater from concrete trucks	<ul style="list-style-type: none"> ▪ Return truck to yard for rinsing into pond or dirt area. ▪ At construction site, wash into pond or dirt area. 	

Discharge/Activity	Business/Commercial	
	Disposal	Approval
Non-hazardous construction and demolition debris	<ul style="list-style-type: none"> ▪ Separate debris (e.g., pressure-treated lumber, coated or partially coated with lead-based paint (LBP), adhesives, asbestos) from recyclable materials (e.g., untreated wood, non-ferrous metals), to the extent feasible at each stage of the construction, or demolition process. ▪ Recycle/reuse (e.g., concrete clean of LBP, untreated wood). ▪ Dispose non-recyclables as solid waste (take to C&D Landfill). 	C&D Landfill
Hazardous demolition and construction debris (e.g. asbestos) (See WM-5, WM-6)	<ul style="list-style-type: none"> ▪ Separate from recyclable materials (to prevent commingling different waste types) to the extent feasible each stage of the construction, demolition process. ▪ Dispose as hazardous waste. 	
Saw-cut slurry	<ul style="list-style-type: none"> ▪ Use dry cutting technique and sweep up residue. ▪ Vacuum slurry and dispose off-site. 	
Construction dewatering (See NS-2)	<ul style="list-style-type: none"> ▪ Recycle/reuse. ▪ Discharge to sanitary sewer. ▪ As appropriate, treat prior to discharge to storm drain. 	POTW, DOH, DPP
Portable toilet waste	<ul style="list-style-type: none"> ▪ Leasing company shall dispose to sanitary sewer at POTW. 	
Leaks from garbage dumpsters (See WM-10)	<ul style="list-style-type: none"> ▪ Collect, contain leaking material. Eliminate leak, keep covered, return to leasing company for immediate repair. ▪ If dumpster is used for liquid waste, use plastic liner. 	
Leaks from construction debris bins (See WM-10)	<ul style="list-style-type: none"> ▪ Insure that bins are used for dry nonhazardous materials only. <p>(Suggestion: Fencing, covering help prevent misuse.)</p>	

Discharge/Activity	Business/Commercial	
	Disposal	Approval
Dumpster cleaning water (See WM-10)	<ul style="list-style-type: none"> ▪ Clean at dumpster’s own facility and discharge waste through grease interceptor to sanitary sewer. ▪ Clean on site and discharge through grease interceptor to sanitary sewer. 	POTW POTW
Cleaning driveways, paved areas (Special Focus = Restaurant alleys, Grocery dumpster areas)	<ul style="list-style-type: none"> ▪ Sweep and dispose as trash (Dry cleaning only). ▪ For vehicle leaks, restaurant/ grocery alleys, follow this 3-step process: <ul style="list-style-type: none"> • Clean up leaks with rags or absorbents. • Sweep, use granular absorbent material (cat litter). • Mop and dispose of mopwater to sanitary sewer (or collect rinsewater and pump to sanitary sewer). 	
Steam cleaning of sidewalks, plazas	<ul style="list-style-type: none"> ▪ Collect all water and pump to sanitary sewer. ▪ Follow this 3-step process: <ul style="list-style-type: none"> • Clean oil leaks with rages or absorbents. • Sweep, using granular absorbent material (cat litter). • Mop and dispose of mopwater to sanitary sewer (or collect rinsewater and pump to the sanitary sewer). 	
Potable water/line flushing. Hydrant testing (See NS-7)	<ul style="list-style-type: none"> ▪ Deactivate chlorine by maximizing time water will travel before reaching streams or the ocean. ▪ Discharge to sanitary sewer. ▪ Complete dechlorination required before discharge to storm drain. <p>Permits are required from the City’s Environmental Services Department and the State DOH.</p>	ENV, SWQ Branch DOH

Discharge/Activity	Business/Commercial	
	Disposal	Approval
<i>Landscape/Garden Maintenance</i>		
Pesticides (See NS-8)	<ul style="list-style-type: none"> ▪ Use up. Rinse containers use rinsewater as product. Dispose rinsed containers as trash. ▪ Dispose unused pesticide as hazardous waste. 	
Garden Clippings	<ul style="list-style-type: none"> ▪ Separate from “inert fill material,” solid waste and recyclable materials to the extent feasible at each stage of the construction or demolition process. ▪ Take to permitted commercial composters (for recycling). 	
Swimming pool, spa, fountain water (emptying)	<ul style="list-style-type: none"> ▪ Do not use metal-based algicides (i.e. Copper Sulfate). ▪ Recycle/reuse (e.g. irrigation). ▪ Dechlorinate, check if pH is acceptable, discharge to storm drain (permit required). 	ENV, SWQ Branch
Swimming pool, spa filter backwash	<ul style="list-style-type: none"> ▪ Reuse for irrigation. ▪ Dispose on dirt area. ▪ Settle, dispose to sanitary sewer. 	
<i>Vehicle Wastes</i>		
Used motor oil (See NS-10)	<ul style="list-style-type: none"> ▪ Store in tanks, containers, or other containers that are in good condition and compatible with the oil, send to permitted recycler via a DOH-permitted transporter. 	
Antifreeze (See NS-10)	<ul style="list-style-type: none"> ▪ DO NOT MIX with other hazardous wastes (solvents, pesticides, used oil). ▪ Store in tanks, containers, or other containers that are in good condition and compatible with the antifreeze, send to permitted recycler. ▪ Dispose as hazardous waste. 	

Discharge/Activity	Business/Commercial	
	Disposal	Approval
Other vehicle fluids and solvents (See NS-10)	<ul style="list-style-type: none"> ▪ DO NOT MIX with hazardous wastes. ▪ Store in tanks, containers, or other containers that are in good condition and compatible with the fluid, send to permitted recycler. 	
Automobile batteries	<ul style="list-style-type: none"> ▪ Send to auto battery recyclers. 	
Refrigerant	<ul style="list-style-type: none"> ▪ Send to an EPA-certified technician who uses EPA-approved recycling/recovery equipment. 	
Motor home/construction trailer waste	<ul style="list-style-type: none"> ▪ Use holding tank. Dispose to sanitary sewer. 	
Vehicle Washing(See NS-8)	<ul style="list-style-type: none"> ▪ Recycle. ▪ Discharge to sanitary sewer. 	POTW
Mobile Vehicle Washing (See NS-8)	<ul style="list-style-type: none"> ▪ Collect washwater and discharge to sanitary sewer. 	
Vehicle leaks at Vehicle Repair Facilities	<ul style="list-style-type: none"> ▪ Follow this 3-step process: <ul style="list-style-type: none"> • Clean up leaks with rags and absorbents. • Sweep, using granular absorbent material (cat litter). • Mop and dispose of mop water to sanitary sewer. 	
<i>Other Wastes</i>		
Carpet cleaning solutions & other mobile washing services	<ul style="list-style-type: none"> ▪ Dispose to sanitary sewer 	POTW
Roof Drains	<ul style="list-style-type: none"> ▪ If roof is contaminated with industrial waste products, discharge to sanitary sewer. ▪ If no contamination is present, discharge to storm drain. 	
Cooling water, except for once through cooling water	<ul style="list-style-type: none"> ▪ Recycle/reuse. ▪ Discharge to sanitary sewer. 	POTW
Pumped groundwater, infiltration/foundation drainage (contaminated)	<ul style="list-style-type: none"> ▪ Recycle/reuse (landscaping, etc.). ▪ Treat if necessary; discharge to sanitary sewer. ▪ Treat and discharge to storm drain. 	POTW ENV, SWQ Branch

Discharge/Activity	Business/Commercial	
	Disposal	Approval
Kitchen Grease	<ul style="list-style-type: none"> ▪ Provide secondary containment, collect, and send to DOH-permitted processor or recycler. <p>NOTE: prior to transport, check with the City and County if POTW is an option, as they may not accept untreated grease.</p>	POTW
Other vehicle fluids and solvents	<ul style="list-style-type: none"> ▪ DO NOT MIX with hazardous wastes ▪ Store in tanks, containers, or other containers that are in good condition and compatible with the fluid, send to permitted recycler. 	
Restaurant cleaning of floor mats, exhaust filters, etc.	<ul style="list-style-type: none"> ▪ Clean inside building with discharge through grease trap to sanitary sewer. ▪ Clean outside in container or bermed area with discharge to sanitary sewer. 	
Clean-up wastewater from sewer backup	<ul style="list-style-type: none"> ▪ Follow this procedure: <ul style="list-style-type: none"> • Block storm drain, contain, collect, and return spilled material to the sanitary sewer. • Block storm drain, rinse remaining material to collection point and pump to sanitary sewer (No rinsewater may flow to storm drain). 	

4.5 NON-STORM WATER MANAGEMENT FACT SHEETS

- NS-1 Water Conservation Practices
- NS-2 Dewatering Operations
- NS-3 Paving and Grinding Operations
- NS-4 Temporary Stream Crossing
- NS-5 Clear Water Diversion
- NS-6 Illicit Connection/Discharge
- NS-7 Potable Water/Irrigation
- NS-8 Vehicle and Equipment Cleaning
- NS-9 Vehicle and Equipment Fueling
- NS-10 Vehicle and Equipment Maintenance
- NS-11 Pile Driving Operations
- NS-12 Concrete Curing
- NS-13 Concrete Finishing
- NS-14 Material Over Water
- NS-15 Demolition Adjacent to Water
- NS-16 Temporary Batch Plants



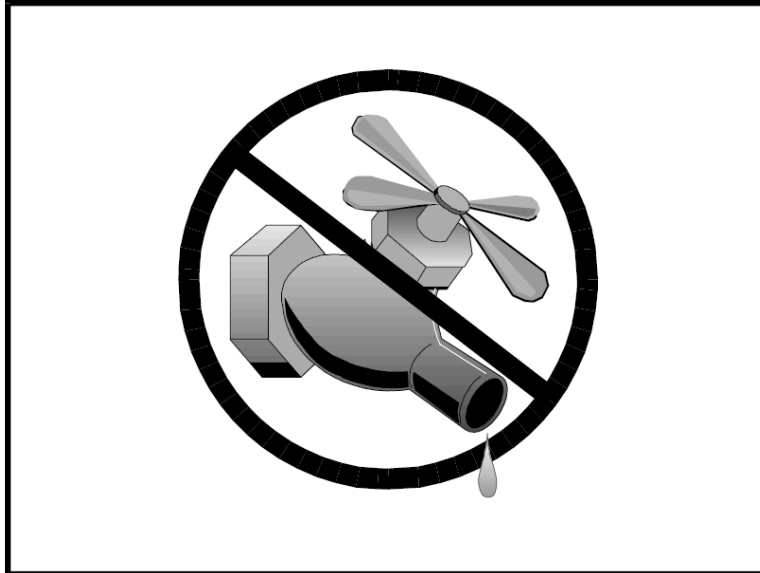

Description and Purpose

Water conservation practices are activities that use water during the construction of a project in a manner that avoids causing erosion and the transport of pollutants offsite. These practices can reduce or eliminate non-storm water discharges.

Suitable Applications

Water conservation practices are suitable for all construction sites where water is used, including piped water, metered water, trucked water, and water from a reservoir.

Limitations

- None identified.

Implementation

- Keep water equipment in good working condition.
- Stabilize water truck filling area.
- Repair water leaks promptly.
- Washing of vehicles and equipment on the construction site is discouraged.
- Avoid using water to clean construction areas. If water must be used for cleaning or surface preparation, surface should be swept and vacuumed first to remove dirt. This will minimize amount of water required.
- Direct construction water runoff to areas where it can soak into the ground or be collected and reused.

Objectives

- EC – Erosion Control ▲
- SE – Sediment Control ▲
- TR – Tracking Control
- WE – Wind Erosion Control
- NS – Non-Storm Water Management Control ✓
- WM – Waste Management & Materials Pollution Control

Legend:

- ✓ Primary Objective
- ▲ Secondary Objective

Targeted Constituents

- Sediment ✓
- Nutrients
- Trash
- Metals
- Bacteria
- Oil and Grease
- Organics

Potential Alternatives

None

- Large dewatering operations have the potential to cause localized ground water gradients to change and may alter the direction of nearby contaminants.
- Authorized non-storm water discharges to the storm drain system, channels, or receiving waters are acceptable with the implementation of appropriate BMPs.
- Lock water tank valves to prevent unauthorized use.

Costs

The cost is small to none compared to the benefits of conserving water.

Inspection and Maintenance

- Inspect and verify that activity based BMPs are in place prior to the commencement of authorized non-storm water discharges.
- Inspect BMPs subject to non-storm water discharges daily while non-storm water discharges are occurring.
- Repair water equipment as needed to prevent unintended discharges:
 - Water trucks,
 - Water reservoirs (water buffalos),
 - Irrigation systems, and
 - Hydrant connections.

References

California Stormwater Quality Association (CASQA) Best Management Practices Handbook Construction, 2003.

Stormwater Quality Handbooks - Construction Site Best Management Practices (BMPs) Manual, State of California Department of Transportation (Caltrans), November 2000.



Description and Purpose

Dewatering operations are practices that manage the discharge of pollutants when non-storm water and accumulated precipitation must be removed from a work location so that construction work may be accomplished.

Suitable Applications

These practices are implemented for discharges of non-storm water from construction sites. Non-storm waters include, but are not limited to, groundwater, water from cofferdams, water diversions, and waters used during construction activities that must be removed from a work area.

Practices identified in this section are also appropriate for implementation when managing the removal of accumulated precipitation (storm water) from depressed areas at a construction site.

Limitations

- Site conditions will dictate design and use of dewatering operations.
- The controls discussed in this best management practice (BMP) address sediment only.
- The controls detailed in this BMP only allow for minimal settling time for sediment particles. Use only when site conditions restrict the use of the other control methods.
- Dewatering operations will require, and must comply with, applicable local permits.

Objectives

- EC – Erosion Control
- SE – Sediment Control ▲
- TR – Tracking Control
- WE – Wind Erosion Control
- NS – Non-Storm Water Management Control ✓
- WM – Waste Management & Materials Pollution Control

Legend:

- ✓ Primary Objective
- ▲ Secondary Objective

Targeted Constituents

- Sediment ✓
- Nutrients
- Trash
- Metals
- Bacteria
- Oil and Grease ✓
- Organics

Potential Alternatives

- SE-5 Fiber Rolls
- SE-6 Gravel Bag Berm

- Dewatered sludge effluent shall not discharge into the storm drain system.
- Avoid dewatering discharges where possible by using the water for dust control, by infiltration, etc.

Implementation

- Dewatering non-storm water cannot be discharged without prior notice to and approval from the State of Hawaii Department of Health, Clean Water Branch (CWB) and City and County of Honolulu Planning and Permitting (DPP). This includes storm water that is co-mingled with groundwater or other non-storm water sources. Once the discharge is allowed, appropriate BMPs must be implemented to ensure the discharge complies with all permit requirements and regional and watershed-specific requirements.
- CWB may require a separate NPDES permit prior to the dewatering discharge of non-storm water. These permits will have specific testing, monitoring, and discharge requirements and can take significant time to obtain.
- The flow chart shown in the figure at the end of this BMP should be utilized to guide dewatering operations.
- The owner will coordinate monitoring and permit compliance.
- Additional permits or permissions from other agencies may be required for dewatering cofferdams or diversions.
- Dewatering discharges must not cause erosion at the discharge point.
- A variety of methods can be used to treat water during dewatering operations. Several devices are presented below and provide options to achieve sediment removal. The size of particles present in the sediment and Permit or receiving water limitations on sediment are key considerations for selecting sediment treatment option(s); in some cases, the use of multiple devices may be appropriate.

Toxics and Petroleum Products

- In areas suspected of having groundwater pollution, sample the groundwater near the excavation site and have the water tested for known or suspected pollutants at a certified laboratory. Check with CWB and City DPP for their requirements for dewatering, additional water quality tests, and disposal options.
- With permits from CWB and City DPP, discharge to the storm drainage system is allowed. With a permit from a publicly owned treatment works (POTW), contaminated groundwater can be treated and discharged to the POTW via sanitary sewer.

Sediment Basin (See also SE-2)

Description:

- A sediment basin is a temporary basin with a controlled release structure that is formed by excavation or construction of an embankment to detain sediment-laden runoff and allow sediment to settle out before discharging. Sediment basins are generally larger than Sediment Traps (SE-3).

Appropriate Applications:

- Effective for the removal of gravel, sand, silt, some metals that settle out with the sediment, and trash.

Implementation:

- Excavation and construction of related facilities is required.
- Temporary sediment basins must be fenced if safety is a concern.
- Outlet protection is required to prevent erosion at the outfall location.

Maintenance:

- Maintenance is required for safety fencing, vegetation, embankment, inlet and outfall structures, as well as other features.
- Removal of sediment is required when the storage volume is reduced by one-half.

Sediment Trap (See also SE-3)

Description:

A sediment trap is a temporary basin formed by excavation and/or construction of an earthen embankment across a waterway or low drainage area to detain sediment-laden runoff and allow sediment to settle out before discharging. Sediment traps are generally smaller than Sediment Basins (SE-2).

Appropriate Applications:

Effective for the removal of large and medium sized particles (sand and gravel) and some metals that settle out with the sediment.

Implementation:

- Excavation and construction of related facilities is required.
- Trap inlets should be located to maximize the travel distance to the trap outlet.
- Use rock or vegetation to protect the trap outlets against erosion.

Maintenance:

- Maintenance is required for vegetation, embankment, inlet and outfall structures, as well as other features.
- Removal of sediment is required when the storage volume is reduced by one-third.

Weir Tanks

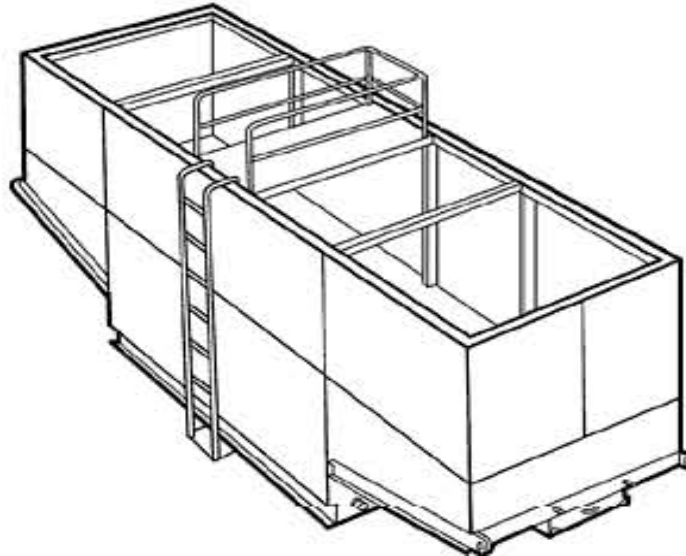

Description:

- A weir tank separates water and waste by using weirs. The configuration of the weirs (over and under weirs) maximizes the residence time in the tank and determines the waste to be removed from the water, such as oil, grease, and sediments.

Appropriate Applications:

- The tank removes trash, some settleable solids (gravel, sand, and silt), some visible oil and grease, and some metals (removed with sediment). To achieve high levels of flow, multiple tanks can be used in parallel. If additional treatment is desired, the tanks can be placed in series or as pre-treatment for other methods.

Implementation:

- Tanks are delivered to the site by the vendor, who can provide assistance with set-up and operation.
- Tank size will depend on flow volume, constituents of concern, and residency period required. Vendors should be consulted to appropriately size tank.

Maintenance:

- Periodic cleaning is required based on visual inspection or reduced flow.
- Oil and grease disposal must be by professional waste disposal company.

Dewatering Tanks



Description:

- A dewatering tank removes debris and sediment. Flow enters the tank through the top, passes through a fabric filter, and is discharged through the bottom of the tank. The filter separates the solids from the liquids.

Appropriate Applications:

- The tank removes trash, gravel, sand, and silt, some visible oil and grease, and some metals (removed with sediment). To achieve high levels of flow, multiple tanks can be used in parallel. If additional treatment is desired, the tanks can be placed in series or as pre-treatment for other methods.

Implementation:

- Tanks are delivered to the site by the vendor, who can provide assistance with set-up and operation.
- Tank size will depend on flow volume, constituents of concern, and residency period required. Vendors should be consulted to appropriately size tank.

Maintenance:

- Periodic cleaning is required based on visual inspection or reduced flow.
- Oil and grease disposal must be by professional waste disposal company.

Gravity Bag Filter

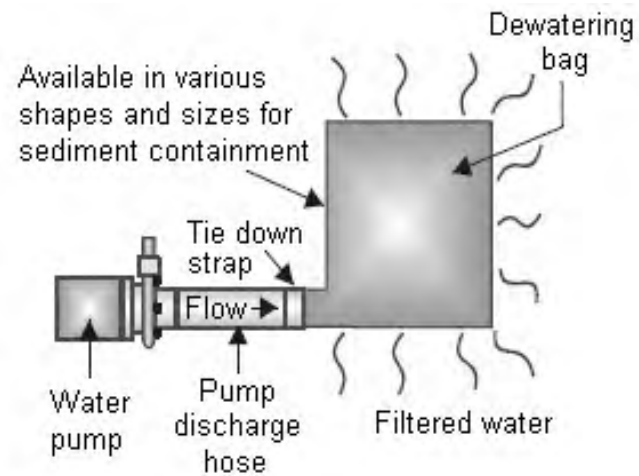

Description:

- A gravity bag filter, also referred to as a dewatering bag, is a square or rectangular bag made of non-woven geotextile fabric that collects sand, silt, and fines.

Appropriate Applications:

- Effective for the removal of sediments (gravel, sand, and silt). Some metals are removed with the sediment.

Implementation:

- Water is pumped into one side of the bag and seeps through the bottom and sides of the bag.
- A secondary barrier, such as a rock filter bed or straw/hay bale barrier, is placed beneath and beyond the edges of the bag to capture sediments that escape the bag.

Maintenance:

- Inspection of the flow conditions, bag condition, bag capacity, and the secondary barrier is required.
- Replace the bag when it no longer filters sediment or passes water at a reasonable rate.
- The bag is disposed of offsite.

Sand Media Particulate Filter



Description:

- Water is treated by passing it through canisters filled with sand media. Generally, sand filters provide a final level of treatment. They are often used as a secondary or higher level of treatment after a significant amount of sediment and other pollutants have been removed using other methods.

Appropriate Applications:

- Effective for the removal of trash, gravel, sand, and silt and some metals, as well as the reduction of biochemical oxygen demand (BOD) and turbidity.
- Sand filters can be used for stand-alone treatment or in conjunction with bag and cartridge filtration if further treatment is required.
- Sand filters can also be used to provide additional treatment to water treated via settling or basic filtration.

Implementation:

- The filters require delivery to the site and initial set up. The vendor can provide assistance with installation and operation.

Maintenance:

- The filters require regular service to monitor and maintain the level of the sand media. If subjected to high loading rates, filters can plug quickly.
- Vendors generally provide data on maximum head loss through the filter. The filter should be monitored daily while in use, and cleaned when head loss reaches target levels.
- If cleaned by backwashing, the backwash water may need to be hauled away for disposal, or returned to the upper end of the treatment train for another pass through the series of dewatering BMPs.

Pressurized Bag Filter



Description:

- A pressurized bag filter is a unit composed of single filter bags made from polyester felt material. The water filters through the unit and is discharged through a header. Vendors provide bag filters in a variety of configurations. Some units include a combination of bag filters and cartridge filters for enhanced contaminant removal.

Appropriate Applications:

- Effective for the removal of sediment (sand and silt) and some metals, as well as the reduction of BOD, turbidity, and hydrocarbons. Oil absorbent bags are available for hydrocarbon removal.
- Filters can be used to provide secondary treatment to water treated via settling or basic filtration.

Implementation:

- The filters require delivery to the site and initial set up. The vendor can provide assistance with installation and operation.

Maintenance:

- The filter bags require replacement when the pressure differential equals or exceeds the manufacturer's recommendation.

Cartridge Filter



Description:

- Cartridge filters provide a high degree of pollutant removal by utilizing a number of individual cartridges as part of a larger filtering unit. They are often used as a secondary or higher polishing) level of treatment after a significant amount of sediment and other pollutants are removed. Units come with various cartridge configurations (for use in series with bag filters) or with a larger single cartridge filtration unit (with multiple filters within).

Appropriate Applications:

- Effective for the removal of sediment (sand, silt, and some clays) and metals, as well as the reduction of BOD, turbidity, and hydrocarbons. Hydrocarbons can effectively be removed with special resin cartridges.
- Filters can be used to provide secondary treatment to water treated via settling or basic filtration.

Implementation:

- The filters require delivery to the site and initial set up. The vendor can provide assistance.

Maintenance:

- The cartridges require replacement when the pressure differential equals or exceeds the manufacturer's recommendation.

Costs

Sediment controls are low to high cost measures depending on the dewatering system that is selected. Pressurized filters tend to be more expensive than gravity settling, but are often more effective. Simple tanks are generally rented on a long-term basis (one or more months) and can range from \$360 per month for a 1,000 gallon tank to \$2,660 per month for a 10,000 gallon tank in California. Mobilization and demobilization costs vary considerably. Note that Hawaii's rental fees are higher than California's unit prices.

Inspection and Maintenance

- Inspect and verify that activity-based BMPs are in place prior to the commencement of associated activities. While activities associated with the BMP are under way, inspect weekly during the rainy season and at two-week intervals in the non-rainy season to verify continued BMP implementation.
- Inspect BMPs subject to non-storm water discharges daily where non-storm water discharges occur.
- Unit-specific maintenance requirements are included with the description of each unit.
- Sediment removed during the maintenance of a dewatering device may be either spread onsite and stabilized, or disposed of at a disposal site as approved by the owner.
- Sediment that is commingled with other pollutants must be disposed of in accordance with all applicable laws and regulations and as approved by the owner.

References

Blueprint for a Clean Bay: Best Management Practices to Prevent Stormwater Pollution from Construction Related Activities; Santa Clara Valley Nonpoint Source Pollution Control Program, 1995.

California Stormwater Quality Association (CASQA) Best Management Practices Handbook Construction, 2003.

Hawaii Administrative Rules 11-55 CWB NOI Form G Construction Activity Dewatering Effluent.

Labor Surcharge & Equipment Rental Rates, April 1, 2002 through March 31, 2003, California Department of Transportation (Caltrans).

Stormwater Management for Construction Activities, Developing Pollution Prevention Plans and Best Management Practices, EPA 832-R-92005; USEPA, April 1992.

Stormwater Quality Handbooks - Construction Site Best Management Practices (BMPs) Manual, State of California Department of Transportation (Caltrans), November 2000.

Dewatering Permit Flow Chart

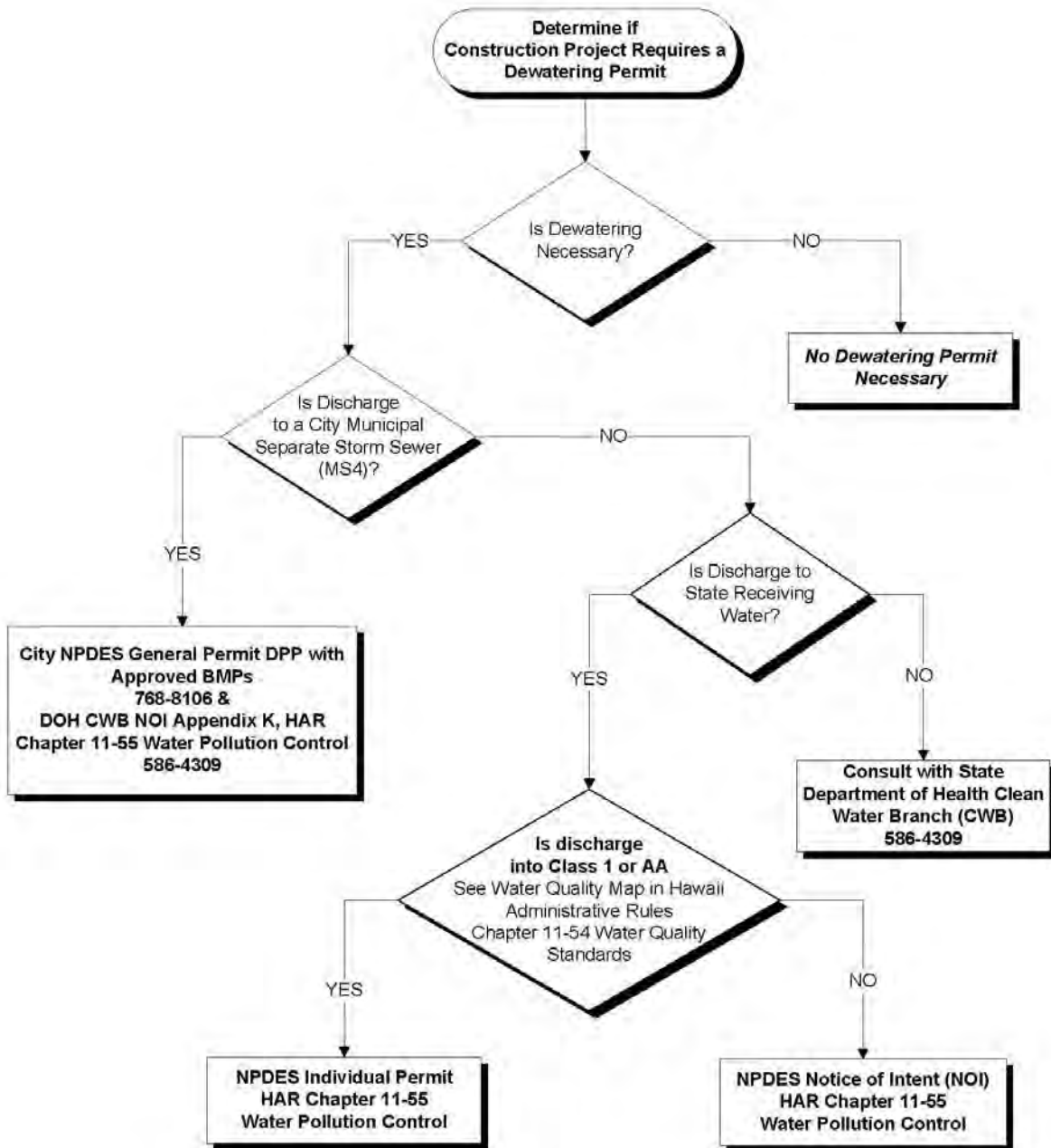

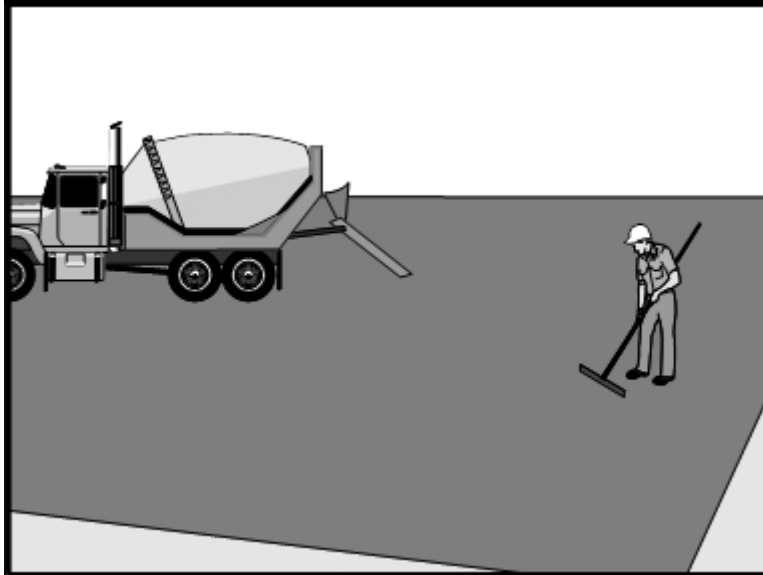

Description and Purpose

Prevent or reduce the discharge of pollutants from paving operations, using measures to prevent runoff and runoff pollution, properly disposing of wastes, and training employees and subcontractors.

Suitable Applications

These procedures are implemented where paving, surfacing, resurfacing, or sawcutting, may pollute storm water runoff or discharge to the storm drain system or watercourses.

Limitations

- Finer solids are not effectively removed by filtration systems.
- Paving opportunities may be limited during wet weather.

Implementation

General

- Avoid paving during the wet season when feasible.
- Reschedule paving and grinding activities if rain is in the forecast.
- Train employees and sub-contractors in pollution prevention and reduction.
- Store materials away from drainage courses to prevent storm water runoff (see WM-1, Material Delivery and Storage).

Objectives

- EC – Erosion Control
- SE – Sediment Control
- TR – Tracking Control
- WE – Wind Erosion Control
- NS – Non-Storm Water Management Control ✓
- WM – Waste Management & Materials Pollution Control ▲

Legend:

- ✓ Primary Objective
- ▲ Secondary Objective

Targeted Constituents

- Sediment ✓
- Nutrients
- Trash
- Metals
- Bacteria
- Oil and Grease ✓
- Organics

Potential Alternatives

None

- Protect drainage courses, particularly in areas with a grade, by employing BMPs to divert runoff or to trap and filter sediment.
- Avoid applying tack or prime coats if rain is expected. Place BMPs to trap and filter oil sheen. Use multiple lines of BMPs to protect drain inlets.
- If paving involves an onsite mixing plant, follow the storm water permitting requirements for industrial activities.
- Stockpile material removed from roadways away from drain inlets, drainage ditches, and watercourses. These materials should be stored consistent with WM-3, Stockpile Management.
- Disposal of PCC and AC waste should be in conformance with WM-8, Concrete Waste Management.

Saw Cutting, Grinding, and Pavement Removal

- Shovel or vacuum saw-cut slurry and remove from site. Cover or barricade storm drains during saw cutting to contain slurry.
- When paving involves AC, the following steps should be implemented to prevent the discharge of grinding residue, uncompacted or loose AC, tack coats, equipment cleaners, or unrelated paving materials:
 - AC grindings, pieces, or chunks used in embankments or shoulder backing must not be allowed to enter any storm drains or watercourses. Install silt fence until structure is stabilized or permanent controls are in place. Examples of temporary perimeter controls can be found in EC-10, Earth Dikes and Drainage Swales; SE-1, Silt Fence; or SE-5, Fiber Rolls;
 - Collect and remove all broken asphalt and recycle when practical. Old or spilled asphalt must be recycled or disposed; and
 - Any AC chunks and pieces used in embankments must be placed above the water table and covered by at least 1 ft. of material.
- Do not allow saw-cut slurry to enter storm drains or watercourses. Residue from grinding operations should be picked up by means of a vacuum attachment to the grinding machine, should not be allowed to flow across the pavement, and should not be left on the surface of the pavement. See also WM-8, Concrete Waste Management, and WM-10, Liquid Waste Management.
- Dig out activities should not be conducted in the rain.
- Collect dig out material by mechanical or manual methods. This material may be recycled for use as shoulder backing or base material.
- If dig out material cannot be recycled, transport the material back to an approved storage site.

Asphaltic Concrete Paving

- If paving involves asphaltic cement concrete, follow these steps:
 - Do not allow sand or gravel placed over new asphalt to wash into storm drains, streets, or streams. Vacuum or sweep loose sand and gravel and properly dispose of this waste by referring to WM-5, Solid Waste Management;

- Old asphalt must be disposed of properly. Collect and remove all broken asphalt from the site and recycle whenever possible; and
- Use of asphalt concrete as fill shall meet inert fill definition given by Hawaii Revised Statutes (HRS) Chapter 342H Solid Waste Pollution.

Portland Cement Concrete Paving

- Do not wash sweepings from exposed aggregate concrete into a storm drain system. Collect and return to aggregate base stockpile or dispose of properly.
- Allow aggregate rinse to settle. Then, either allow rinse water to dry in a lined temporary pit as described in WM-8, Concrete Waste Management, or pump the water to the sanitary sewer if allowed by the local (Federal, City or private) wastewater authority.

Sealing Operations

- During chip seal application and sweeping operations, petroleum or petroleum covered aggregate must not be allowed to enter any storm drain or water courses. Apply temporary perimeter controls until structure is stabilized.
- Drainage inlet structures and manholes should be covered with filter fabric during application of seal coat, tack coat, slurry seal, and fog seal.
- Seal coat, tack coat, slurry seal, or fog seal should not be applied if rainfall is predicted to occur during the application or curing period.

Paving Equipment

- Leaks and spills from paving equipment can contain toxic levels of heavy metals and oil and grease. Place drip pans or absorbent materials under paving equipment when not in use. Clean up spills with absorbent materials rather than burying. See NS-10, Vehicle and Equipment Maintenance, WM-4, Spill Prevention and Control, and WM-10, Liquid Waste Management.
- Substances used to coat asphalt transport trucks, and asphalt spreading equipment should not contain soap and should be non-foaming and non-toxic.
- Use only non-toxic substances to coat asphalt transport trucks and asphalt spreading equipment.
- Paving equipment parked onsite should be parked over plastic to prevent soil contamination.
- Clean asphalt coated equipment offsite whenever possible. When cleaning dry, hardened asphalt from equipment, manage hardened asphalt debris as described in WM-5, Solid Waste Management. Any cleaning onsite should follow NS-8, Vehicle and Equipment Cleaning.

Thermoplastic Striping

- Thermoplastic striper and pre-heater equipment shutoff valves should be inspected to ensure that they are working properly to prevent leaking thermoplastic from entering drain inlets, the storm water drainage system, or watercourses.
- Pre-heaters should be filled carefully to prevent splashing or spilling of hot thermoplastic. Leave six inches of space at the top of the pre-heater container when filling thermoplastic to allow room for material to move when the vehicle is deadheaded.

- Do not pre-heat, transfer, or load thermoplastic near drain inlets or watercourses.
- Clean truck beds daily of loose debris and melted thermoplastic. When possible, recycle thermoplastic material.

Raised/Recessed Pavement Marker Application and Removal

- Do not transfer or load bituminous material near drain inlets, the storm water drainage system, or watercourses.
- Melting tanks should be loaded with care and not filled to beyond six inches from the top to leave room for splashing when vehicle is deadheaded.
- When servicing or filling melting tanks, ensure all pressure is released before removing lids to avoid spills.
- On large-scale projects, use mechanical or manual methods to collect excess bituminous material from the roadway after removal of markers.

Costs

- All of the above are low cost measures.

Inspection and Maintenance

- Inspect and verify that activity-based BMPs are in place prior to the commencement of associated activities. While activities associated with the BMP are under way, inspect weekly during the rainy season and at two-week intervals in the non-rainy season to verify continued BMP implementation.
- Keep ample supplies of drip pans or absorbent materials onsite.
- Inspect and maintain machinery regularly to minimize leaks and drips.

References

Blueprint for a Clean Bay: Best Management Practices to Prevent Stormwater Pollution from Construction Related Activities; Santa Clara Valley Nonpoint Source Pollution Control Program, 1995.

California Stormwater Quality Association (CASQA) Best Management Practices Handbook Construction, 2003.

Hot Mix Asphalt-Paving Handbook AC 150/5370-14, Appendix I, U.S. Army Corps of Engineers, July 1991.

Stormwater Quality Handbooks - Construction Site Best Management Practices (BMPs) Manual, State of California Department of Transportation (Caltrans), November 2000.

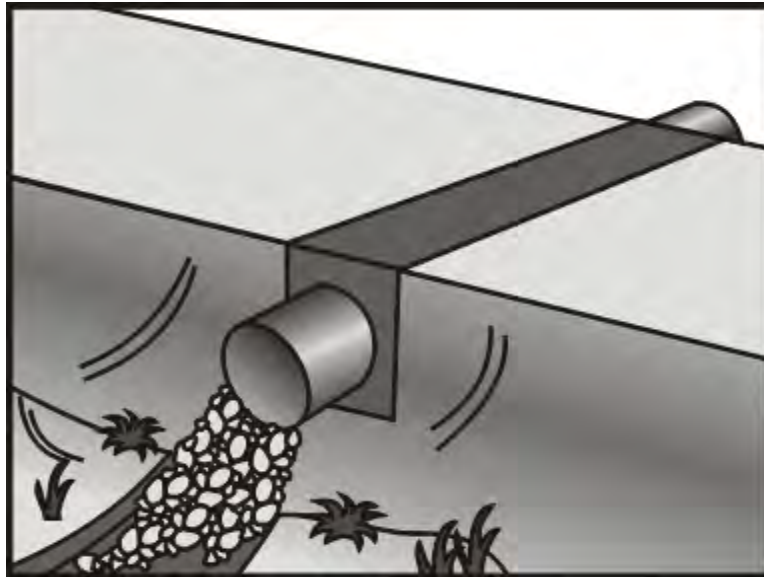

Description and Purpose

A temporary stream crossing is a temporary culvert, ford or bridge placed across a waterway to provide access for construction purposes for a period of less than one year. Temporary access crossings are not intended to maintain traffic for the public. The temporary access will eliminate erosion and downstream sedimentation caused by vehicles.

Suitable Applications

Temporary stream crossings should be installed at all designated crossings of perennial and intermittent streams on the construction site, as well as for dry channels that may be significantly eroded by construction traffic.

Temporary streams crossings are installed at sites:

- Where appropriate permits have been secured (U.S. Army Corps of Engineers 404 Permits, and State of Hawaii Department of Health, Clean Water Branch (CWB) 401 Certifications), State Department of Land and Natural Resources (DLNR), Commission on Water Resource Management (CWRM), and Stream Channel Alteration Permit (HAR Title 13, Chapter 169-50, Protection of Instream Uses);
- Where construction equipment or vehicles need to frequently cross a waterway;
- When alternate access routes impose significant constraints;
- When crossing perennial streams or waterways causes significant erosion;

Objectives

EC – Erosion Control	▲
SE – Sediment Control	▲
TR – Tracking Control	▲
WE – Wind Erosion Control	
NS – Non-Storm Water Management Control	√
WM – Waste Management & Materials Pollution Control	

Legend:

- √ Primary Objective
- ▲ Secondary Objective

Targeted Constituents

Sediment	√
Nutrients	
Trash	
Metals	
Bacteria	
Oil and Grease	
Organics	

Potential Alternatives

None

- Where construction activities will not last longer than one year; and/or
- Where appropriate permits have been obtained for the stream crossing.

Limitations

The following limitations may apply:

- Installation and removal will usually disturb the waterway;
- Installation may require CWB 401 Certification, and U.S. Army Corps of Engineers 404 permit. If numerical-based water quality standards are mentioned in any of these and other related permits, testing and sampling may be required;
- Installation may require dewatering or temporary diversion of the stream. See NS-2, Dewatering Operations and NS-5, Clear Water Diversion;
- Installation may cause a constriction in the waterway, which can obstruct flood flow and cause flow backups or washouts. If improperly designed, flow backups can increase the pollutant load through washouts and scouring;
- Use of natural or other gravel in the stream for construction of Cellular Confinement System (CCS) ford crossing will be contingent upon approval by fisheries agencies;
- Ford crossings may degrade water quality due to contact with vehicles and equipment;
- May be expensive for a temporary improvement;
- Requires other BMPs to minimize soil disturbance during installation and removal;
- Fords should only be used in dry weather; and/or
- Liability for damage resulting from the culvert is with the design engineer/contractor. It should be designed so it will not create flooding problems.

Implementation

General

The purpose of this BMP is to provide a safe, erosion-free access across a stream for construction equipment. Minimum standards and specifications for the design, construction, maintenance, and removal of the structure should be established by an engineer registered in Hawaii. Temporary stream crossings may be necessary to prevent construction equipment from causing erosion of the stream and tracking sediment and other pollutants into the stream.

Temporary stream crossings are used as access points to construction sites when other detour routes may be too long or burdensome for the construction equipment. Often heavy construction equipment must cross streams or creeks, and detour routes may impose too many constraints such as being too narrow or poor soil strength for the equipment loadings. Additionally, the contractor may find a temporary stream crossing more economical for light-duty vehicles to use for frequent crossings, and may have less environmental impact than construction of a temporary access road.

Location of the temporary stream crossing should address:

- Site selection where erosion potential is low; and
- Areas where the side slopes from site runoff will not spill into the side slopes of the crossing.

The following types of temporary stream crossings should be considered:

- **Culverts** - A temporary culvert is effective in controlling erosion but will cause erosion during installation and removal. A temporary culvert can be easily constructed and allows for heavy equipment loads;
- **Fords** - Appropriate during the dry season in arid areas. Used on dry washes and ephemeral streams, and low-flow perennial streams. CCS, a type of ford crossing, is also appropriate for use in streams that would benefit from an influx of gravels. A temporary ford provides little sediment and erosion control and is ineffective in controlling erosion in the stream channel. A temporary ford is the least expensive stream crossing and allows for maximum load limits. It also offers very low maintenance. Fords are more appropriate during the dry season and in arid areas; and
- **Bridges** - Appropriate for streams with high flow velocities, steep gradients and where temporary restrictions in the channel are not allowed.

Design

During the summer construction season, rainfall is infrequent and many streams are dry. Under these conditions, a temporary ford may be sufficient. A ford is not appropriate if construction will continue through the winter rainy season, if summer thunderstorms are likely, or if the stream flows during most of the year. Temporary culverts and bridges should then be considered and, if used, should be sized to pass a significant design storm (i.e., at least a 10-year storm). The temporary stream crossing should be protected against erosion, both to prevent excessive sedimentation in the stream and to prevent washout of the crossing.

Design and installation requires knowledge of stream flows and soil strength. Designs should be prepared under direction of, and approved by, a registered civil engineer and for bridges, a registered structural engineer. Both hydraulic and construction loading requirements should be considered with the following:

- Comply with any special requirements for culvert and bridge crossings, particularly if the temporary stream crossing will remain through the rainy season;
- Provide stability in the crossing and adjacent areas to withstand the design flow. The design flow and safety factor should be selected based on careful evaluation of the risks due to over topping, flow backups, or washout;
- Install sediment traps immediately downstream of crossings to capture sediments. See SE-3, Sediment Trap;
- Avoid oil or other potentially hazardous materials for surface treatment;
- Culverts are relatively easy to construct and able to support heavy equipment loads;
- Fords are the least expensive of the crossings, with maximum load limits;
- CCS crossing structures consist of clean, washed gravel and cellular confinement system blocks. CCS is appropriate for streams that would benefit from an influx of gravel; for example: streams or rivers below reservoirs, and urban, channelized streams. Many urban stream systems are gravel-deprived due to human influences, such as dams, gravel quarries, and concrete channels;
- CCS allows designers to use either angular or naturally occurring rounded gravel, because the cells provide the necessary structure and stability. In fact, natural gravel is

optimal for this technique, because of the habitat improvement it will provide after removal of the CCS;

- A gravel depth of 6 to 12 in. for a CCS structure is sufficient to support most construction equipment;
- An advantage of a CCS crossing structure is that relatively little rock or gravel is needed, because the CCS provides the stability; and
- Bridges are generally more expensive to design and construct, but provide the least disturbance of the streambed and constriction of the waterway flows.

Construction and Use

- Stabilize construction roadways, adjacent work area, and stream bottom against erosion.
- Construct during dry periods to minimize stream disturbance and reduce costs.
- Construct at or near the natural elevation of the streambed to prevent potential flooding upstream of the crossing.
- Install temporary erosion control BMPs in accordance with erosion control BMP fact sheets to minimize erosion of embankment into flow lines.
- Any temporary artificial obstruction placed within flowing water should only be built from material, such as clean gravel or sandbags, that will not introduce sediment or silt into the watercourse.
- Temporary water body crossings and encroachments should be constructed to minimize scour. Cobbles used for temporary water body crossings or encroachments should be clean, rounded stream cobble.
- Vehicles and equipment should not be driven, operated, fueled, cleaned, maintained, or stored in the wet or dry portions of a water body where wetland vegetation, riparian vegetation, or aquatic organisms may be destroyed.
- The exterior of vehicles and equipment that will encroach on the water body within the project should be maintained free of grease, oil, fuel, and residues.
- Drip pans should be placed under all vehicles and equipment placed on docks, barges, or other structures over water bodies when the vehicle or equipment is planned to be idle for more than one hour.
- Disturbance or removal of vegetation should not exceed the minimum necessary to complete operations. Precautions should be taken to avoid damage to vegetation by people or equipment. Disturbed vegetation should be replaced with the appropriate soil stabilization measures.
- Riparian vegetation, when removed pursuant to the provisions of the work, should be cut off no lower than ground level to promote rapid re-growth. Access roads and work areas built over riparian vegetation should be covered by a sufficient layer of clean river run cobble to prevent damage to the underlying soil and root structure. The cobble must be removed upon completion of project activities.
- Conceptual temporary stream crossings are shown in the attached figures.
- Construction in waterways is subject to additional permit requirements. Contact the US Army Corps of Engineers and State Department of Land and Natural Resources for additional information.

Costs

Caltrans Construction Cost index for temporary bridge crossings is \$45-\$95/ft². Note that Hawaii's unit prices are higher than California's unit prices and cost of regulatory permits not included in estimated unit cost.

Inspection and Maintenance

- Inspect and verify that activity-based BMPs are in place prior to the commencement of associated activities. While activities associated with the BMP are under way, inspect weekly during the rainy season and at two week intervals in the non-rainy season to verify continued BMP implementation.
- Check for blockage in the channel, sediment buildup or trapped debris in culverts, blockage behind fords or under bridges.
- Check for erosion of abutments, channel scour, riprap displacement, or piping in the soil.
- Check for structural weakening of the temporary crossings, such as cracks, and undermining of foundations and abutments.
- Remove sediment that collects behind fords, in culverts, and under bridges periodically.
- Replace lost or displaced aggregate from inlets and outlets of culverts and cellular confinement systems.
- Remove temporary crossing promptly when it is no longer needed.

References

California Bank and Shore Rock Slope Protection Design - Practitioners Guide and Field Evaluations of Riprap Methods, Caltrans Study No. F90TL03, October 2000.

California Stormwater Quality Association (CASQA) Best Management Practices Handbook Construction, 2003.

Hawaii Administrative Rules, Title 11, Chapter 54, Water Quality Standards Section 404 of the Clean Water Act.

Hawaii Administrative Rules, Title 13, Chapter 169-50, Protection of Instream Uses of Water.

Stormwater Quality Handbooks - Construction Site Best Management Practices (BMPs) Manual, State of California Department of Transportation (Caltrans), November 2000.

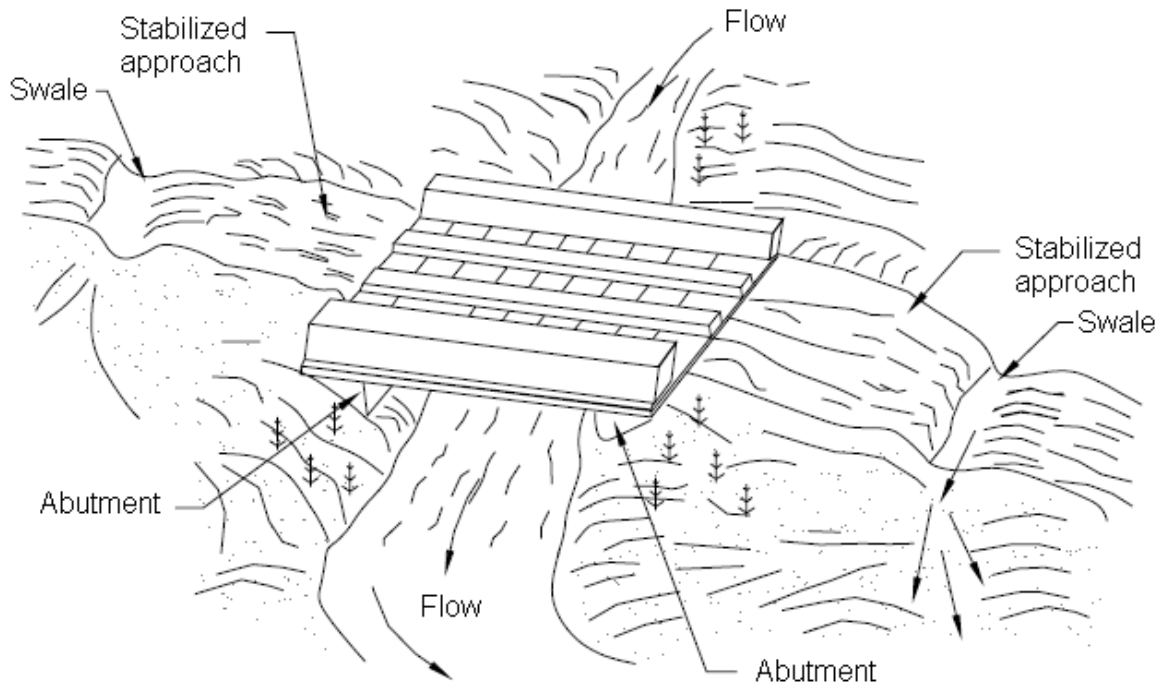

NOTE:
Surface flow of road diverted
by swale and/or dike.

TYPICAL BRIDGE CROSSING
NOT TO SCALE

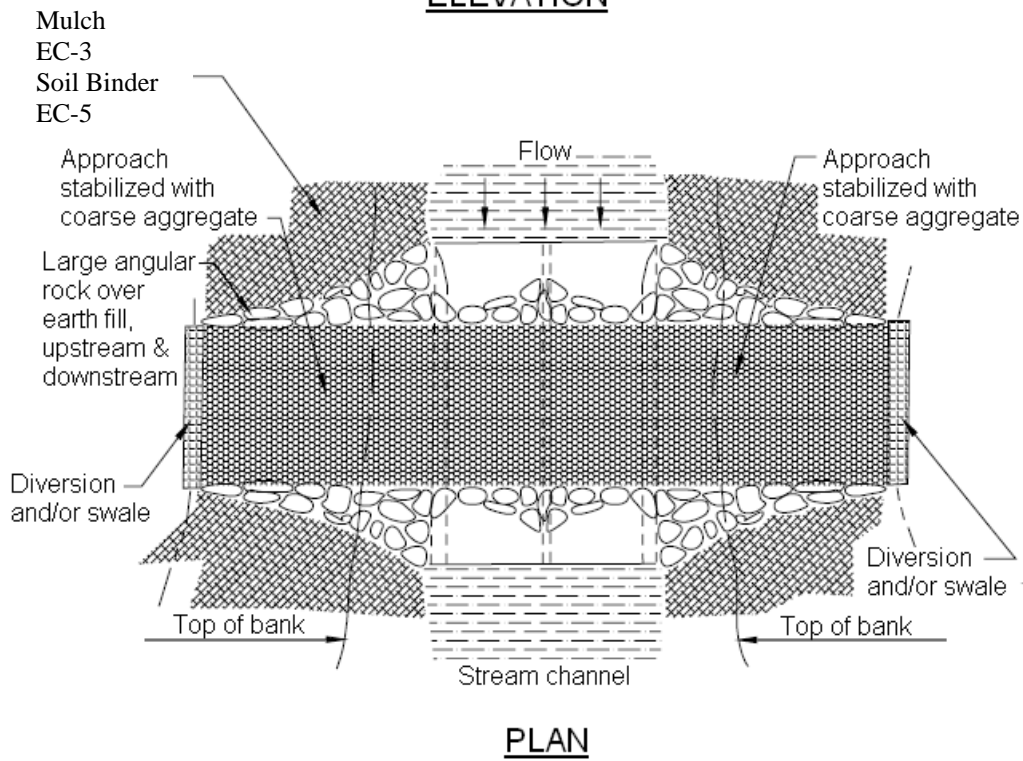
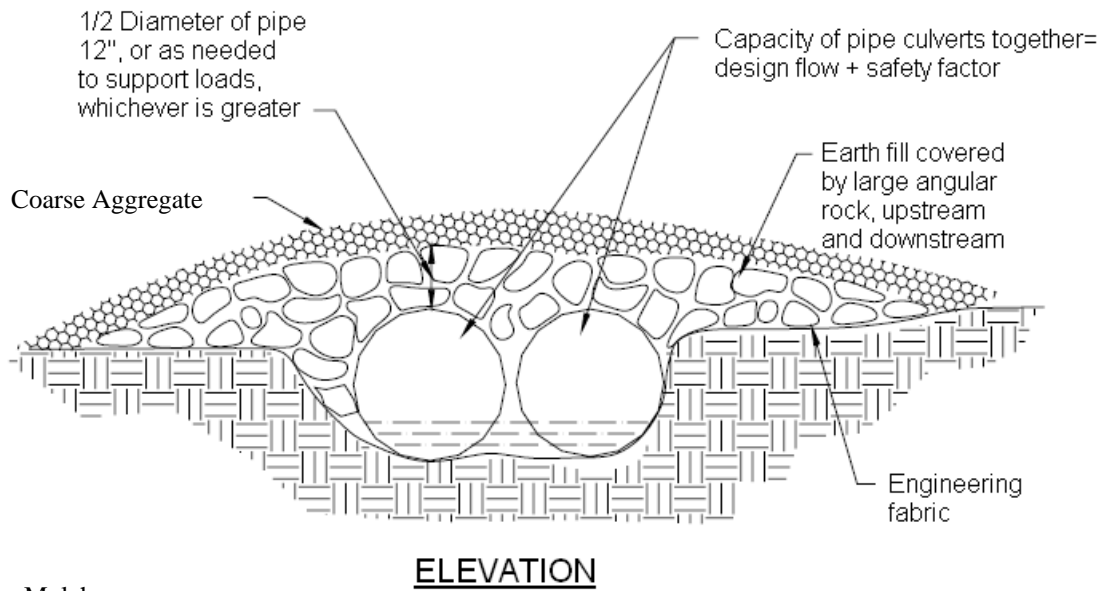

TYPICAL CULVERT CROSSING
NOT TO SCALE

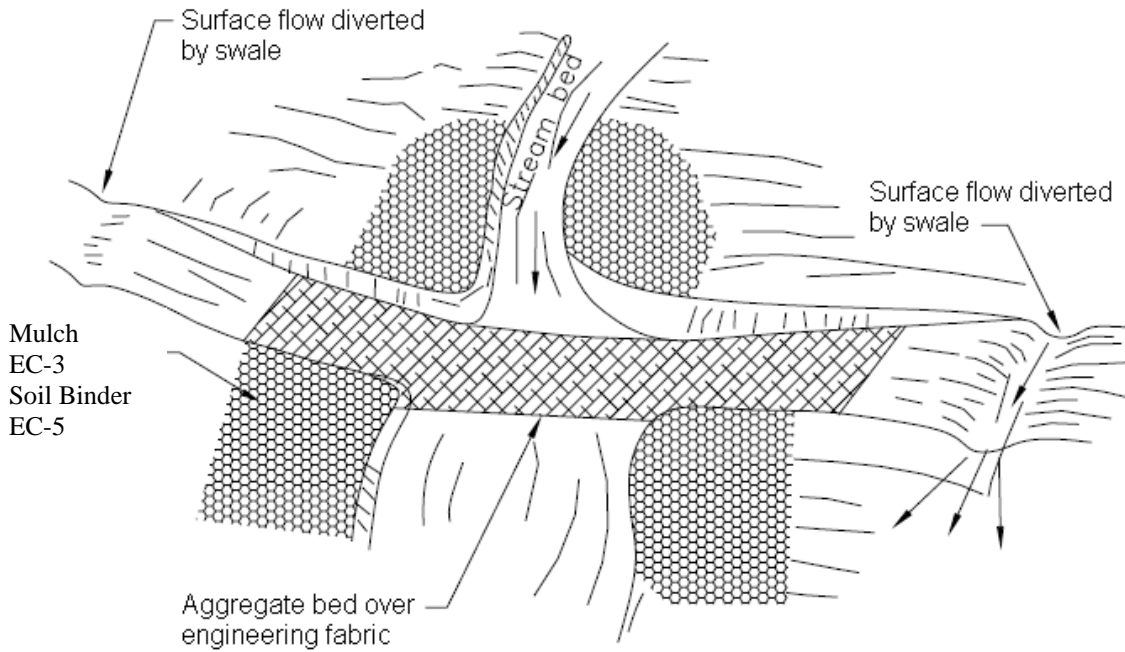

Aggregate approach
1:5 (V:H) Maximum slope of road

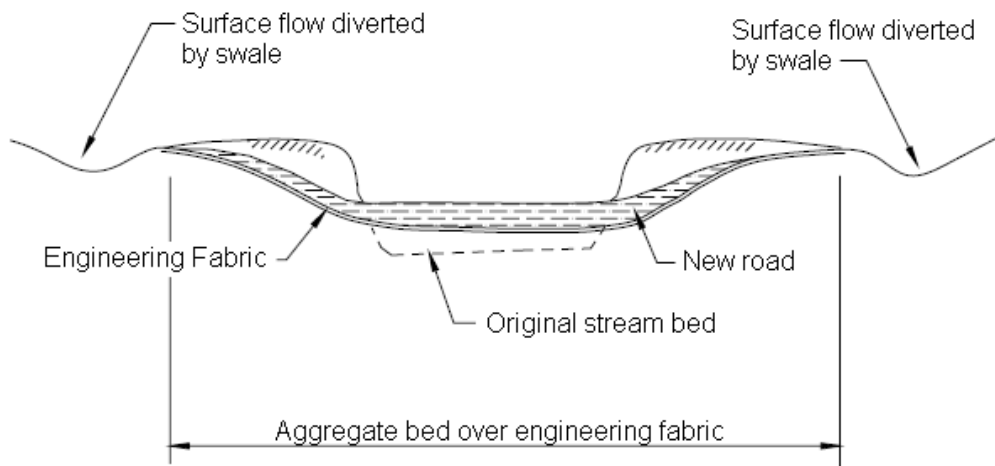

TYPICAL FORD CROSSING
NOT TO SCALE

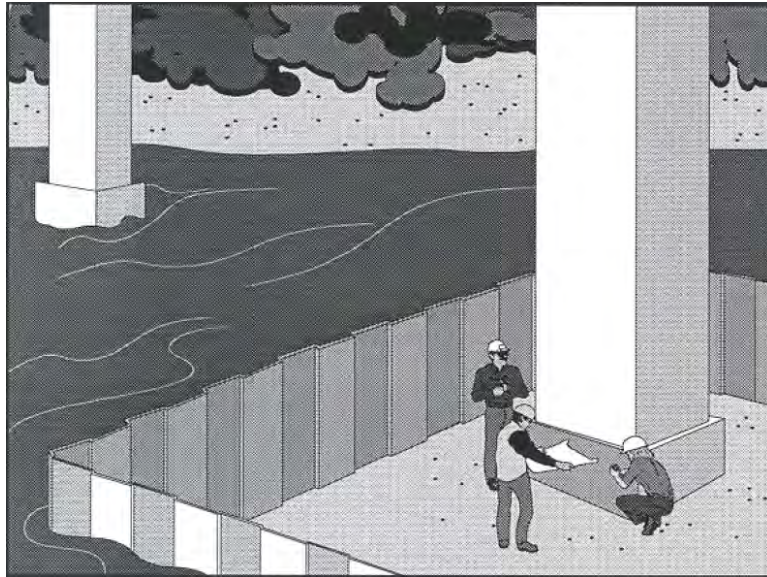

Description and Purpose

Clear water diversion consists of a system of structures and measures that intercept clear surface water runoff upstream of a project, transport it around the work area, and discharge it downstream with minimal water quality degradation from either the project construction operations or the construction if the diversion. Clear water diversions are used in a waterway to enclose a construction area and reduce sediment pollution from construction work occurring in or adjacent to water. Structures commonly used as part of this system include diversion ditches, berms, dikes, slope drains, rock, gravel bags, wood, aqua barriers, cofferdams, filter fabric or turbidity curtains, drainage and interceptor swales, pipes, or flumes.

Suitable Applications

A clear water diversion is typically implemented where appropriate permits have been secured and work must be performed in a flowing stream or water body.

- Clear water diversions are appropriate for isolating construction activities occurring within or near a water body such as streambank stabilization, or culvert, bridge, pier or abutment installation. They may also be used in combination with other methods, such as clear water bypasses and/or pumps.
- Pumped diversions are suitable for intermittent and low flow streams.

Objectives

- EC – Erosion Control
- SE – Sediment Control
- TR – Tracking Control
- WE – Wind Erosion Control
- NS – Non-Storm Water Management Control ✓
- WM – Waste Management & Materials Pollution Control

Legend:

- ✓ Primary Objective
- ▲ Secondary Objective

Targeted Constituents

- Sediment ✓
- Nutrients
- Trash
- Metals
- Bacteria
- Oil and Grease
- Organics

Potential Alternatives

None

- Excavation of a temporary bypass channel, or passing the flow through a heavy pipe (called a “flume”) with a trench excavated under it, is appropriate for the diversion of streams less than 20 ft. wide, with flow rates less than 100 cfs.

Limitations

- Diversion and encroachment activities will usually disturb the waterway during installation and removal of diversion structures.
- Installation may require State of Hawaii Department of Health, Clean Water Branch (CWB) 401 Certification, State Department of Land and Natural Resources (DLNR), Commission on Water Resource Management (CWRM), Stream Channel Alteration Permit (HAR Title 13, Chapter 169-50, Protection of Instream Uses of Water), and U.S. Army Corps of Engineers 404 permit. If numerical-based water quality standards are mentioned in any of these and other related permits, testing and sampling may be required.
- Diversion and encroachment activities may constrict the waterway, which can obstruct flood flows and cause flooding or washouts. Diversion structures should not be installed without identifying potential impacts to the stream channel.
- Diversion or isolation activities are not appropriate in channels where there is insufficient stream flow to support aquatic species in the area dewatered as a result of the diversion.
- Diversion or isolation activities are inappropriate in deep water unless designed or reviewed by an engineer registered in Hawaii.
- Diversion or isolation activities should not completely dam stream flow.
- Dewatering and removal may require additional sediment control or water treatment. See NS-2, Dewatering Operations.
- Not appropriate if installation, maintenance, and removal of the structures will disturb sensitive aquatic species of concern.

Implementation

General

- Implement guidelines presented in EC-12, Streambank Stabilization to minimize impacts to streambanks.
- Where working areas encroach on flowing streams, barriers adequate to prevent the flow of muddy water into streams should be constructed and maintained between working areas and streams. During construction of the barriers, muddying of streams should be held to a minimum.
- Diversion structures must be adequately designed to accommodate fluctuations in water depth or flow volume due to tides, storms, flash floods, etc.
- Heavy equipment driven in wet portions of a water body to accomplish work should be completely clean of petroleum residue, and water levels should be below the fuel tanks, gearboxes, and axles of the equipment unless lubricants and fuels are sealed such that inundation by water will not result in discharges of fuels, oils, greases, or hydraulic fluids.
- If one portion of the stream is pumped it may trigger a Stream Diversion Works Permit (HAR Title 13, Chapter 168-32 to 35: Water Use, Wells, and Stream Diversion Works).

- Excavation equipment buckets may reach out into the water for the purpose of removing or placing fill materials. Only the bucket of the crane/ excavator/backhoe may operate in a water body. The main body of the crane/excavator/backhoe should not enter the water body except as necessary to cross the stream to access the work site.
- Stationary equipment such as motors and pumps located within or adjacent to a water body should be positioned over drip pans.
- When any artificial obstruction is being constructed, maintained, or placed in operation, sufficient water should, at all times, be allowed to pass downstream to maintain aquatic life.
- Equipment should not be parked below the high water mark unless allowed by a permit.
- Disturbance or removal of vegetation should not exceed the minimum necessary to complete operations. Precautions should be taken to avoid damage to vegetation by people or equipment. Disturbed vegetation should be replaced with the appropriate erosion control measures.
- Riparian vegetation approved for trimming as part of the project should be cut off no lower than ground level to promote rapid re-growth. Access roads and work areas built over riparian vegetation should be covered by a sufficient layer of clean river run cobble to prevent damage to the underlying soil and root structure. The cobble should be removed upon completion of project activities.
- Drip pans should be placed under all vehicles and equipment placed on docks, barges, or other structures over water bodies when the vehicle or equipment is planned to be idle for more than 1 hour.
- Where possible, avoid or minimize diversion and encroachment impacts by scheduling construction during periods of low flow or when the stream is dry. Scheduling should also consider seasonal releases of water from dams, fish migration and spawning seasons, and water demands due to crop irrigation.
- Construct diversion structures with materials free of potential pollutants such as soil, silt, sand, clay, grease, or oil.

Temporary Diversions and Encroachments

- Construct diversion channels in accordance with EC-9, Earth Dikes and Drainage Swales.
- In high flow velocity areas, stabilize slopes of embankments and diversion ditches using an appropriate liner, in accordance with EC-7, Geotextiles and Mats, or use rock slope protection.
- Where appropriate, use natural streambed materials such as large cobbles and boulders for temporary embankment and slope protection, or other temporary soil stabilization methods.
- Provide for velocity dissipation at transitions in the diversion, such as the point where the stream is diverted to the channel and the point where the diverted stream is returned to its natural channel. See also EC-10, Velocity Dissipation Devices.

Temporary Dry Construction Areas

- When dewatering behind temporary structures to create a temporary dry construction area, such as cofferdams, pass pumped water through a sediment-settling device, such as a portable tank or settling basin, before returning water to the water body. See also NS-2, Dewatering Operations.
- Any substance used to assemble or maintain diversion structures, such as form oil, should be non-toxic and non-hazardous.
- Any material used to minimize seepage underneath diversion structures, such as grout, should be non-toxic, non-hazardous, and as close to a neutral pH as possible.

Comparison of Diversion and Isolation Techniques:

- Gravel bags are relatively inexpensive, but installation and removal can be labor intensive. It is also difficult to dewater the isolated area. Sandbags should not be used for this technique in rivers or streams, as sand should never be put into or adjacent to a stream, even if encapsulated in geotextile.
- Gravel Bag Berms (SE-6) used in conjunction with an impermeable membrane are cost effective, and can be dewatered relatively easily. Only clean, washed gravel should be used for both the gravel bag and gravel berm techniques.
- Cofferdams are relatively expensive, but frequently allow full dewatering. Also, many options now available are relatively easy to install.
- Sheet pile enclosures are a much more expensive solution, but do allow full dewatering. This technique is not well suited to small streams, but can be effective on large rivers or lakes, and where staging and heavy equipment access areas are available.
- K-rails are an isolation method that does not allow full dewatering, but can be used in small to large watercourses, and in fast-water situations.
- A relatively inexpensive isolation method is filter fabric isolation. This method involves placement of gravel bags or continuous berms to ‘key-in’ the fabric, and subsequently staking the fabric in place. This method should be used in relatively calm water, and can be used in smaller streams. Note that this is not a dewatering method, but rather a sediment isolation method.
- Turbidity curtains should be used where sediment discharge to a stream is unavoidable. They can also be used for in-stream construction, when dewatering an area is not required.
- When used in watercourses or streams, cofferdams must be used in accordance with permit requirements.
- Manufactured diversion structures should be installed following manufacturer’s specifications.
- Filter fabric and turbidity curtain isolation installation methods can be found in the specific technique descriptions that follow.

Filter Fabric Isolation Technique

Definition and Purpose

A filter fabric isolation structure is a temporary structure built into a waterway to enclose a construction area and reduce sediment pollution from construction work in or adjacent to water. This structure is composed of filter fabric, gravel bags, and steel t-posts.

Appropriate Applications

- Filter fabric may be used for construction activities such as streambank stabilization, or culvert, bridge, pier or abutment installation. It may also be used in combination with other methods, such as clean water bypasses and/or pumps.
- Filter fabric isolation is relatively inexpensive. This method involves placement of gravel bags or continuous berms to 'key-in' the fabric, and subsequently staking the fabric in place.
- This method should be used in relatively calm water, and can be used in smaller streams. This is not a dewatering method, but rather a sediment isolation method.
- Water levels inside and outside the fabric curtain must be about the same, as differential heads will cause the curtain to collapse.

Limitations

- Do not use if the installation, maintenance and removal of the structures will disturb sensitive aquatic species of concern.
- Filter fabrics are not appropriate for projects where dewatering is necessary.
- Filter fabrics are not appropriate to completely dam stream flow.

Design and Installation

- For the filter fabric isolation method, a non-woven or heavy-duty fabric is recommended over standard silt fence. Using rolled geotextiles allows non-standard widths to be used.
- Anchor filter fabric with gravel bags filled with clean, washed gravel. Do not use sand. If a bag should split open, the gravel can be left in the stream, where it can provide aquatic habitat benefits. If a sandbag splits open in a watercourse, the sand could cause a decrease in water quality, and could bury sensitive aquatic habitat.
- Another anchor alternative is a continuous berm, made with the Continuous Berm Machine. This is a gravel-filled bag that can be made in very long segments. The length of the berms is usually limited to 18 ft. for ease of handling (otherwise, it gets too heavy to move).
- Place the fabric on the bottom of the stream, and place either a bag of clean, washed gravel or a continuous berm over the bottom of the silt fence fabric, such that a bag-width of fabric lies on the stream bottom. The bag should be placed on what will be the outside of the isolation area.
- Pull the fabric up, and place a metal t-post immediately behind the fabric, on the inside of the isolation area; attach the silt fence to the post with three diagonal nylon ties.
- Continue placing fabric as described above until the entire work area has been isolated, staking the fabric at least every 6 ft.

Inspection and Maintenance

- Immediately repair any gaps, holes or scour.
- Remove and properly dispose of sediment buildup.
- Remove BMP upon completion of construction activity. Recycle or reuse if applicable.
- Revegetate areas disturbed by BMP removal if needed.

Turbidity Curtain Isolation Technique

Definition and Purpose

A turbidity curtain is a fabric barrier used to isolate the near shore work area. The barriers are intended to confine the suspended sediment. The curtain is a floating barrier, and thus does not prevent water from entering the isolated area; rather, it prevents suspended sediment from getting out.

Appropriate Applications

Turbidity curtains should be used where sediment discharge to a stream is unavoidable. They are used when construction activities adjoin quiescent waters, such as lakes, ponds, and slow flowing streams. The curtains are designed to deflect and contain sediment within a limited area and provide sufficient retention time so that the sediment particles will fall out of suspension.

Limitations

- Turbidity curtains should not be used in flowing water; they are best suited for use in ponds, lakes, and very slow-moving streams.
- Turbidity curtains should not be placed across the width of a channel.
- Removing sediment that has been deflected and settled out by the curtain may create a discharge problem through the resuspension of particles and by accidental dumping by the removal equipment.

Design and Installation

- Turbidity curtains should be oriented parallel to the direction of flow.
- The curtain should extend the entire depth of the watercourse in calm-water situations.
- In wave conditions, the curtain should extend to within 1 ft. of the bottom of the watercourse, such that the curtain does not stir up sediment by hitting the bottom repeatedly. If it is desirable for the curtain to reach the bottom in an active-water situation, a pervious filter fabric may be used for the bottom 1 ft.
- The top of the curtain should consist of flexible flotation buoys, and the bottom should be held down by a load line incorporated into the curtain fabric. The fabric should be a brightly colored impervious mesh.
- The curtain should be held in place by anchors placed at least every 100 ft.
- First, place the anchors, then tow the fabric out in a furled condition, and connect to the anchors. The anchors should be connected to the flotation devices, and not to the bottom of the curtain. Once in place, cut the furling lines, and allow the bottom of the curtain to sink.
- Consideration must be given to the probable outcome of the removal procedure. It must be determined if it will create more of a sediment problem through re-suspension of the

particles or by accidental dumping of material during removal. It is recommended that the soil particles trapped by the turbidity curtain only be removed if there has been a significant change in the original contours of the affected area in the watercourse.

- Particles should always be allowed to settle for a minimum of 6 to 12 hours prior to their removal or prior to removal of the turbidity curtain.

Maintenance and Inspection

- The curtain should be inspected for holes or other problems, and any repairs needed should be made promptly.
- Allow sediment to settle for 6 to 12 hours prior to removal of sediment or curtain. This means that after removing sediment, wait an additional 6 to 12 hours before removing the curtain.
- To remove, install furling lines along the curtain, detach from anchors, and tow out of the water.

K-rail River Isolation

Definition and Purpose

This temporary sediment control or stream isolation method uses K-rails (or Jersey barriers) to form the sediment deposition area, or to isolate the in-stream or near-bank construction area.

Barriers are placed end-to-end in a pre-designed configuration and gravel-filled bags are used at the toe of the barrier and at their abutting ends to seal and prevent movement of sediment beneath or through the barrier walls.

Appropriate Applications

The K-rail isolation can be used in streams with higher water velocities than many other isolation techniques.

- This technique is also useful at the toe of embankments, and cut or fill slopes.

Limitations

- The K-rail method should not be used to dewater a project site, as the barrier is not watertight.

Design and Installation

- To create a floor for the K-rail, move large rocks and obstructions. Place washed gravel and gravel-filled bags to create a level surface for K-rails to sit. Washed gravel should always be used.
- Place the bottom two K-rails adjacent to each other, and parallel to the direction of flow; fill the center portion with gravel bags. Then place the third K-rail on top of the bottom two. There should be sufficient gravel bags between the bottom K-rails such that the top rail is supported by the gravel. Place plastic sheeting around the K-rails, and secure at the bottom with gravel bags.
- Further support can be added by pinning and cabling the K-rails together. Also, large riprap and boulders can be used to support either side of the K-rail, especially where there is strong current.

Inspection and Maintenance:

- The barrier should be inspected and any leaks, holes, or other problems should be addressed immediately.
- Sediment should be allowed to settle for at least 6 to 12 hours prior to removal of sediment, and for 6 to 12 hours prior to removal of the barrier.

Stream Diversions

The selection of which stream diversion technique to use will depend upon the type of work involved, physical characteristics of the site, and the volume of water flowing through the project.

Advantages of a Pumped Diversion

- Downstream sediment transport can be nearly eliminated.
- Dewatering of the work area is possible.
- Pipes can be moved around to allow construction operations.
- The dams can serve as temporary access to the site.
- Increased flows can be managed by adding more pumping capacity.

Disadvantages of a Pumped Diversion

- Flow volume is limited by pump capacity.
- A pumped diversion requires 24 hour monitoring of pumps.
- Sudden rain could overtop dams.
- Erosion at the outlet.
- Minor in-stream disturbance is required to install and remove dams.

Advantages of Excavated Channels and Flumes

- Excavated channels isolate work from water flow and allow dewatering.
- Excavated channels can handle larger flows than pumps.

Disadvantages of Excavated Channels and Flumes

- Bypass channel or flume must be sized to handle flows, including possible floods.
- Channels must be protected from erosion.
- Flow diversion and re-direction with small dams involves in-stream disturbance and mobilization of sediment.

Design and Installation

- Installation guidelines will vary based on existing site conditions and type of diversion used.
- Pump capacity must be sufficient for design flow.
- A standby pump is required in case a primary pump fails.
- Dam materials used to create dams upstream and downstream of diversion should be erosion resistant; materials such as steel plate, sheet pile, sandbags, continuous berms, inflatable water bladders, etc., would be acceptable.

When constructing a diversion channel, begin excavation of the channel at the proposed downstream end, and work upstream. Once the watercourse to be diverted is reached and the excavated channel is stable, breach the upstream end and allow water to flow down the new channel. Once flow has been established in the diversion channel, install the diversion weir in the main channel; this will force all water to be diverted from the main channel.

Inspection and Maintenance

- Pumped diversions require 24 hour monitoring of pumps.
- Inspect embankments and diversion channels for damage to the linings, accumulating debris, sediment buildup, and adequacy of the slope protection. Remove debris and repair linings and slope protection as required. Remove holes, gaps, or scour.
- Upon completion of work, the diversion or isolation structure should be removed and flow should be redirected through the new culvert or back into the original stream channel. Recycle or reuse if applicable.
- Revegetate areas disturbed by BMP removal if needed.

Costs

Costs of clear water diversion vary considerably and can be very high.

Inspection and Maintenance

Inspect and verify that activity-based BMPs are in place prior to the commencement of associated activities. While activities associated with the BMP are under way, inspect weekly during the rainy season and at two-week intervals in the non-rainy season to verify continued BMP implementation.

Inspect BMPs subject to non-storm water discharges daily while non-storm water discharges occur.

Refer to BMP-specific inspection and maintenance requirements.

References

California Bank and Shore Rock Slope Protection Design – Practitioners Guide and Field Evaluations of Riprap Methods, Caltrans Study No. F90TL03, October, 2000.

California Stormwater Quality Association (CASQA) Best Management Practices Handbook Construction, 2003.

Hawaii Administrative Rules, Title 11, Chapter 54, Water Quality Standards.

Hawaii Administrative Rules, Title 13, Chapter 169-50, Protection of Instream Uses of Water.

Hawaii Administrative Rules, Title 13, Chapter 168-32 to 35, Water Use, Wells, and Stream Diversion Works.

Section 404 of the Clean Water Act.

Stormwater Quality Handbooks - Construction Site Best Management Practices (BMPs) Manual, State of California Department of Transportation (Caltrans), November 2000.

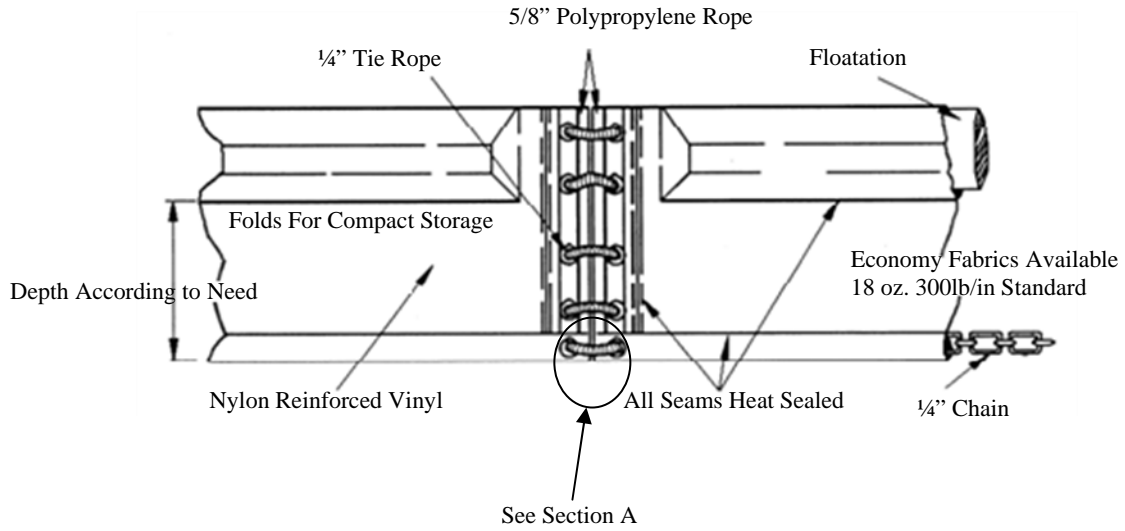

Section A
Shackle Connection

Type 1 Turbidity Curtain

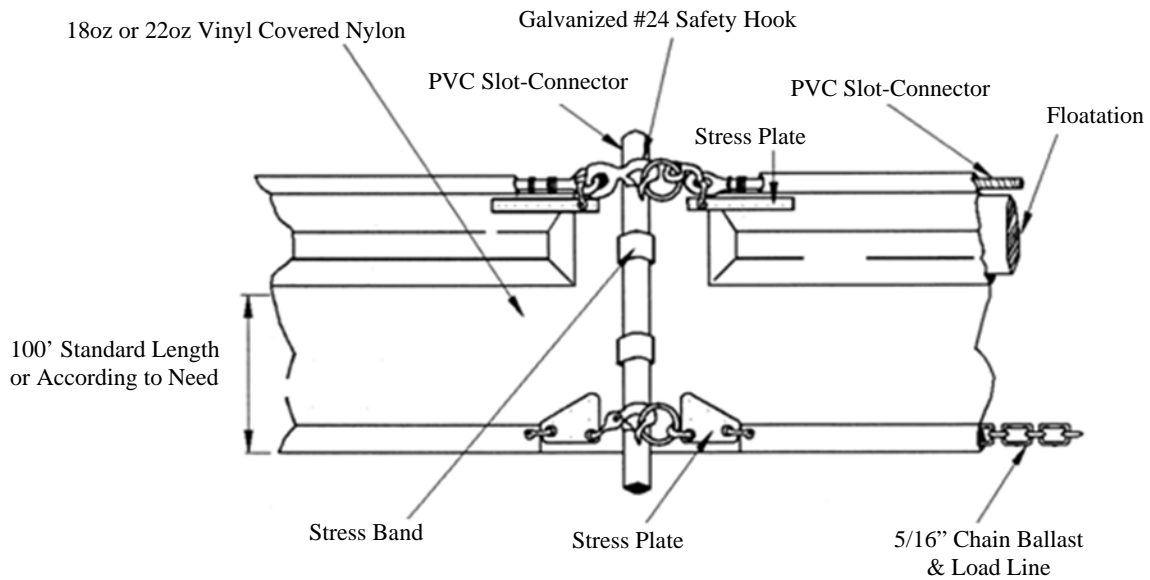

Type 2 Turbidity Curtain

Source: American Boom and Barrier Corp. product literature

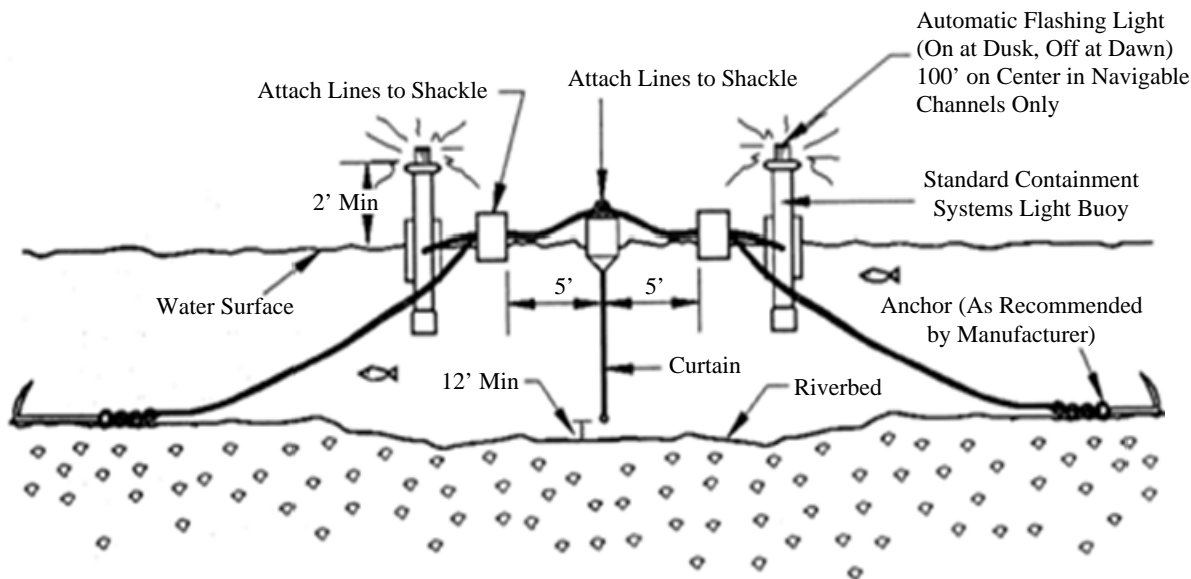
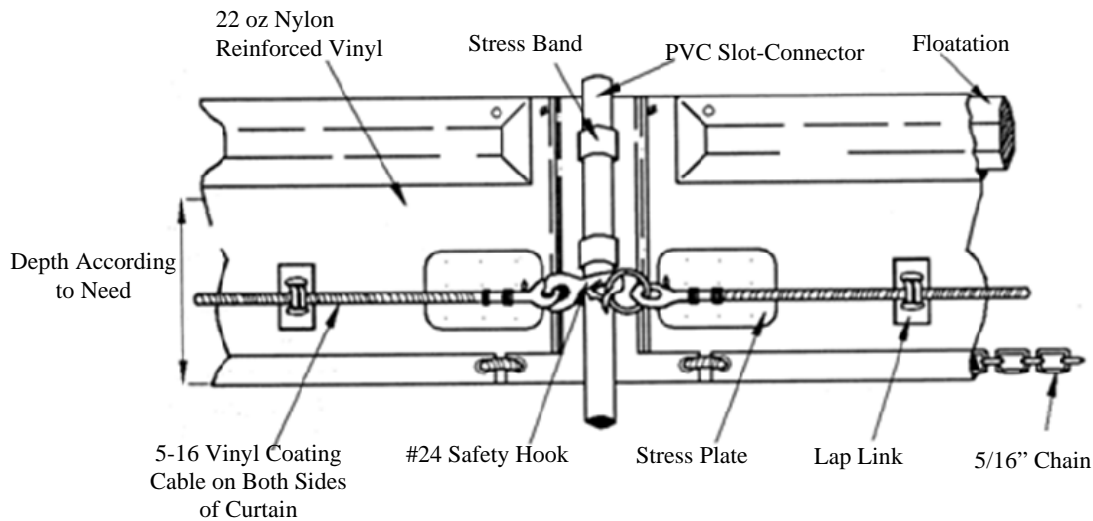

Tidal Situation Orientation

Type 3 Turbidity Curtain

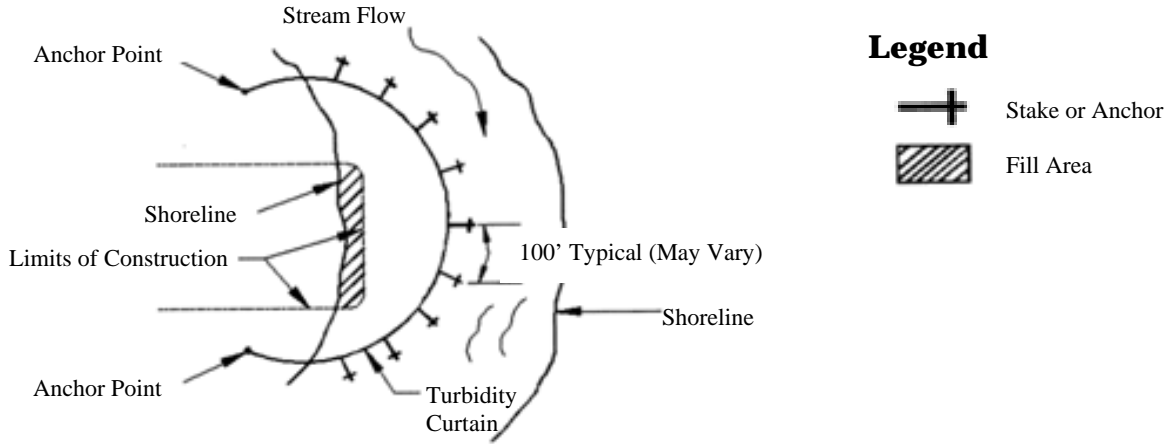

Source: Adapted from American Boom and Barrier Corp. and VDOT Standard Sheets

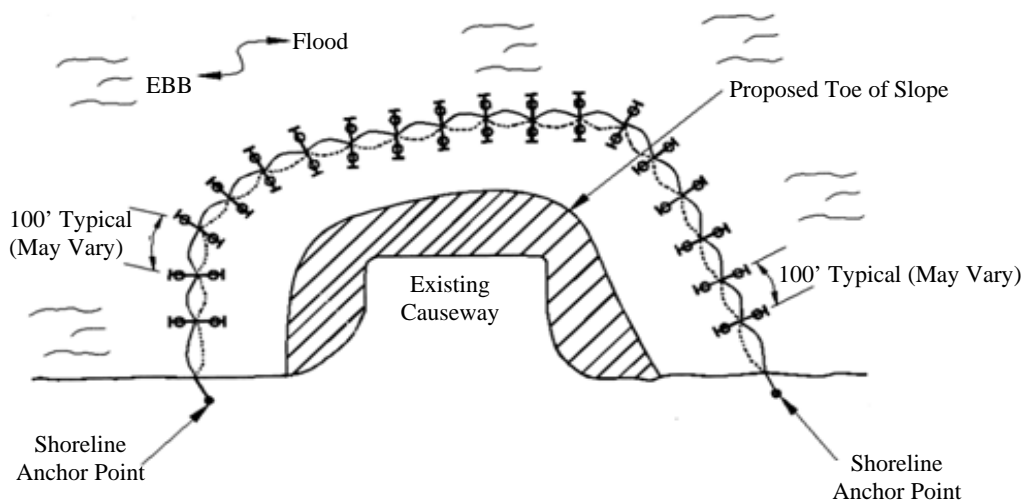

Streams, Ponds & Lakes (Protected & Non-Tidal)



Legend

-  Anchor & Anchor Buoy
-  Barrier Movement due to Tidal Change
-  Barrier Movement due to Tidal Change

Tidal Waters and/or Heavy Wind & Wave Action

Turbidity Curtain Typical Layouts

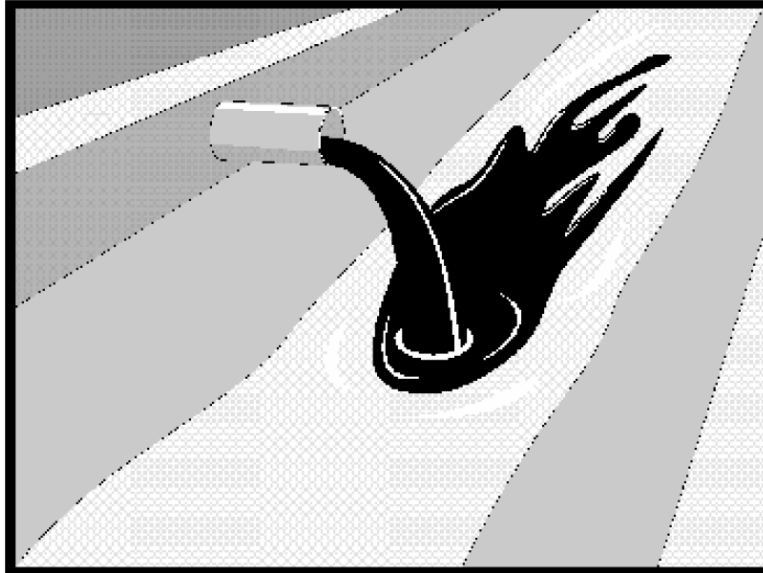

Description and Purpose

Procedures and practices designed for construction contractors to recognize illicit connections or illegally dumped or discharged materials on a construction site and report incidents.

Suitable Applications

This best management practice (BMP) applies to all construction projects. Illicit connection/discharge and reporting is applicable anytime an illicit connection or discharge is discovered or illegally dumped material is found on the construction site.

Limitations

Illicit connections and illegal discharges or dumping, for the purposes of this BMP, refer to discharges and dumping caused by parties other than the contractor. If pre-existing hazardous materials or wastes are known to exist onsite, they should be identified in the site-specific BMPs plan and handled as set forth in the site-specific BMPs plan.

Implementation

Planning

- Review the site-specific BMPs plan. Pre-existing areas of contamination should be identified and documented in the site-specific BMPs plan.
- Inspect site before beginning the job for evidence of illicit connections, illegal dumping or discharges. Document any pre-existing conditions and notify the owner.

Objectives

- EC – Erosion Control
- SE – Sediment Control
- TR – Tracking Control
- WE – Wind Erosion Control
- NS – Non-Storm Water Management Control ✓
- WM – Waste Management & Materials Pollution Control

Legend:

- ✓ Primary Objective
- ▲ Secondary Objective

Targeted Constituents

- Sediment
- Nutrients ✓
- Trash ✓
- Metals ✓
- Bacteria ✓
- Oil and Grease ✓
- Organics ✓

Potential Alternatives

None

- Inspect site regularly during project execution for evidence of illicit connections, illegal dumping or discharges.
- Observe site perimeter for evidence for potential of illicitly discharged or illegally dumped material, which may enter the job site.

Identification of Illicit Connections and Illegal Dumping or Discharges

- **General** – unlabeled and unidentifiable material should be treated as hazardous.
- **Solids** – Look for debris, or rubbish piles. Solid waste dumping often occurs on roadways with light traffic loads or in areas not easily visible from the traveled way.
- **Liquids** – signs of illegal liquid dumping or discharge can include:
 - Visible signs of staining or unusual colors to the pavement or surrounding adjacent soils;
 - Pungent odors coming from the drainage systems;
 - Discoloration or oily substances in the water or stains and residues detained within ditches, channels or drain boxes; and/or
 - Abnormal water flow during the dry weather season.
- **Urban Areas** – Evidence of illicit connections or illegal discharges is typically detected at storm drain outfall locations or at manholes. Signs of an illicit connection or illegal discharge can include:
 - Abnormal water flow during the dry weather season;
 - Unusual flows in sub drain systems used for dewatering;
 - Pungent odors coming from the drainage systems;
 - Discoloration or oily substances in the water or stains and residues detained within ditches, channels or drain boxes; and/or
 - Excessive sediment deposits, particularly adjacent to or near active offsite construction projects.
- **Rural Areas** – Illicit connections or illegal discharges involving irrigation drainage ditches are detected by visual inspections. Signs of an illicit discharge can include:
 - Abnormal water flow during the non-irrigation season;
 - Non-standard junction structures; and/or
 - Broken concrete or other disturbances at or near junction structures.

Reporting

Notify the owner of any illicit connections and illegal dumping or discharge incidents at the time of discovery. For illicit connections or discharges to the storm drain system, notify the local storm water management agency. For illegal dumping, notify the local law enforcement agency.

Cleanup and Removal

The responsibility for cleanup and removal of illicit or illegal dumping or discharges will vary by location. Contact the local storm water management agency for further information.

Costs

Costs to look for and report illicit connections and illegal discharges and dumping are low. The best way to avoid costs associated with illicit connections and illegal discharges and dumping is to keep the project perimeters secure to prevent access to the site, to observe the site for vehicles that should not be there, and to document any waste or hazardous materials that exist onsite before taking possession of the site.

Inspection and Maintenance

- Inspect and verify that activity-based BMPs are in place prior to the commencement of associated activities. While activities associated with the BMP are under way, inspect weekly during the rainy season and at two-week intervals in the non-rainy season to verify continued BMP implementation.
- Inspect the site regularly to check for any illegal dumping or discharge.
- Prohibit employees and subcontractors from disposing of non-job related debris or materials at the construction site.
- Notify the owner of any illicit connections and illegal dumping or discharge incidents at the time of discovery.

References

Blueprint for a Clean Bay: Best Management Practices to Prevent Stormwater Pollution from Construction Related Activities; Santa Clara Valley Nonpoint Source Pollution Control Program, 1995.

California Stormwater Quality Association (CASQA) Best Management Practices Handbook Construction, 2003.

Stormwater Management for Construction Activities, Developing Pollution Prevention Plans and Best Management Practices, EPA 832-R-92005; USEPA, April 1992.

Stormwater Quality Handbooks - Construction Site Best Management Practices (BMPs) Manual, State of California Department of Transportation (Caltrans), November 2000.

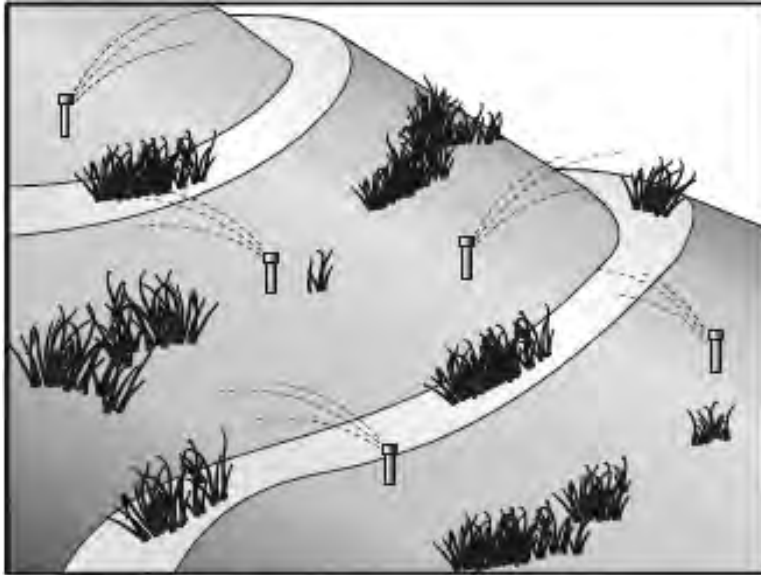

Description and Purpose

Potable Water/Irrigation consists of practices and procedures to manage the discharge of potential pollutants generated during discharges from irrigation water lines, landscape irrigation, lawn or garden watering, planned and unplanned discharges from potable water sources, water line flushing, and hydrant flushing.

Suitable Applications

Implement this BMP whenever potable water or irrigation water discharges occur at or enter a construction site.

Limitations

None identified.

Implementation

- Direct water from offsite sources around or through a construction site, where feasible, in a way that minimizes contact with the construction site.
- Discharges from water line flushing should be reused for landscaping purposes where feasible.
- Shut off the water source to broken lines, sprinklers, or valves as soon as possible to prevent excess water flow.
- Recommend installation of rain shut-off devices and precision sprinkler heads for irrigation systems.
- Protect downstream storm water drainage systems and watercourses from water pumped or bailed from trenches excavated to repair water lines.

Objectives

- EC – Erosion Control
- SE – Sediment Control
- TR – Tracking Control
- WE – Wind Erosion Control
- NS – Non-Storm Water Management Control ✓
- WM – Waste Management & Materials Pollution Control

Legend:

- ✓ Primary Objective
- ▲ Secondary Objective

Targeted Constituents

Sediment	✓
Nutrients	✓
Trash	
Metals	✓
Bacteria	
Oil and Grease	
Organics	✓

Potential Alternatives

None

- Inspect irrigated areas within the construction limits for excess watering. Adjust watering times and schedules to ensure that the appropriate amount of water is being used and to minimize runoff. Consider factors such as soil structure, grade, time of year, and type of plant material in determining the proper amounts of water for a specific area.

Costs

Cost to manage potable water and irrigation are low and generally considered to be a normal part of related activities.

Inspection and Maintenance

- Inspect and verify that activity-based BMPs are in place prior to the commencement of associated activities. While activities associated with the BMP are under way, inspect weekly during the rainy season and at two-week intervals in the non-rainy season to verify continued BMP implementation.
- Inspect BMPs subject to non-storm water discharges daily while non-storm water discharges occur.
- Repair broken water lines as soon as possible.
- Inspect irrigated areas regularly for signs of erosion and/or discharge.

References

Blueprint for a Clean Bay: Best Management Practices to Prevent Stormwater Pollution from Construction Related Activities; Santa Clara Valley Nonpoint Source Pollution Control Program, 1995.

California Stormwater Quality Association (CASQA) Best Management Practices Handbook Construction, 2003.

Stormwater Management for Construction Activities, Developing Pollution Prevention Plans and Best Management Practices, EPA 832-R-92005; USEPA, April 1992.

Stormwater Quality Handbooks - Construction Site Best Management Practices (BMPs) Manual, State of California Department of Transportation (Caltrans), November 2000.

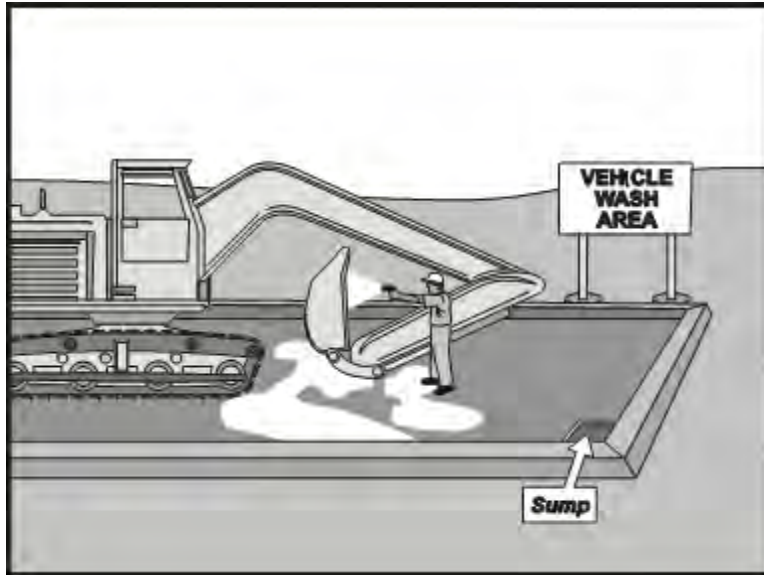

Description and Purpose

Vehicle and equipment cleaning procedures and practices eliminate or reduce the discharge of pollutants to storm water from vehicle and equipment cleaning operations. Procedures and practices include but are not limited to: using offsite facilities; washing in designated, contained areas only; eliminating discharges to the storm drain by infiltrating the wash water; and training employees and subcontractors in proper cleaning procedures.

Suitable Applications

These procedures are suitable on all construction sites where vehicle and equipment cleaning is performed.

Limitations

Even phosphate-free, biodegradable soaps have been shown to be toxic to fish before the soap degrades. Sending vehicles/equipment offsite should be done in conjunction with TR-1, Stabilized Construction Entrance/Exit.

Implementation

Other options to washing equipment onsite include contracting with either an offsite or mobile commercial washing business. These businesses may be better equipped to handle and dispose of the wash waters properly. Performing this work offsite can also be economical by eliminating the need for a separate washing operation onsite.

Objectives

- EC – Erosion Control
- SE – Sediment Control
- TR – Tracking Control
- WE – Wind Erosion Control
- NS – Non-Storm Water Management Control ✓
- WM – Waste Management & Materials Pollution Control

Legend:

- ✓ Primary Objective
- ▲ Secondary Objective

Targeted Constituents

Sediment	✓
Nutrients	✓
Trash	
Metals	
Bacteria	
Oil and Grease	✓
Organics	✓

Potential Alternatives

None

If washing operations are to take place onsite, then:

- Use phosphate-free, biodegradable soaps;
- Educate employees and subcontractors on pollution prevention measures;
- Do not permit steam cleaning onsite. Steam cleaning can generate significant pollutant concentrates;
- Cleaning of vehicles and equipment with soap, solvents or steam should not occur on the project site unless resulting wastes are fully contained and disposed of. Resulting wastes should not be discharged or buried, and must be captured and recycled or disposed according to the requirements of WM-10, Liquid Waste Management or WM-6, Hazardous Waste Management, depending on the waste characteristics. Minimize use of solvents. Use of diesel for vehicle and equipment cleaning is prohibited;
- All vehicles and equipment that regularly enter and leave the construction site must be cleaned offsite;
- When vehicle and equipment washing and cleaning must occur onsite, and the operation cannot be located within a structure or building equipped with appropriate disposal facilities, the outside cleaning area should have the following characteristics:
 - Located away from storm drain inlets, drainage facilities, or watercourses;
 - Paved with concrete or asphalt and bermed to contain wash waters and to prevent runoff and runoff;
 - Configured with a sump to allow collection and disposal of wash water;
 - No discharge of wash waters to storm drains or watercourses; and
 - Used only when necessary.
- When cleaning vehicles and equipment with water:
 - Install high-efficiency water fixtures. Use as little water as possible. High-pressure sprayers may use less water than a hose and should be considered;
 - Use positive shutoff valve to minimize water usage; and
 - Facility wash racks should discharge to a sanitary sewer, recycle system or other approved discharge system and must not discharge to the storm drainage system, watercourses, or to groundwater.

Costs

Cleaning vehicles and equipment at an offsite facility may reduce overall costs for vehicle and equipment cleaning by eliminating the need to provide similar services onsite. When onsite cleaning is needed, the cost to establish appropriate facilities is relatively low on larger, long-duration projects, and moderate to high on small, short-duration projects.

Inspection and Maintenance

Inspect and verify that activity-based BMPs are in place prior to the commencement of associated activities. While activities associated with the BMP are under way, inspect weekly during the rainy season and at two-week intervals in the non-rainy season to verify continued BMP implementation.

- Inspect BMPs subject to non-storm water discharges daily while non-storm water discharges occur.
- Inspection and maintenance is minimal, although some berm repair may be necessary.
- Monitor employees and subcontractors throughout the duration of the construction project to ensure appropriate practices are being implemented.
- Inspect sump regularly and remove liquids and sediment as needed.
- Prohibit employees and subcontractors from washing personal vehicles and equipment on the construction site.

References

California Stormwater Quality Association (CASQA) Best Management Practices Handbook Construction, 2003.

Stormwater Quality Handbooks - Construction Site Best Management Practices (BMPs) Manual, State of California Department of Transportation (Caltrans), November 2000.

Swisher, R.D. Surfactant Biodegradation, Marcel Decker Corporation, 1987.

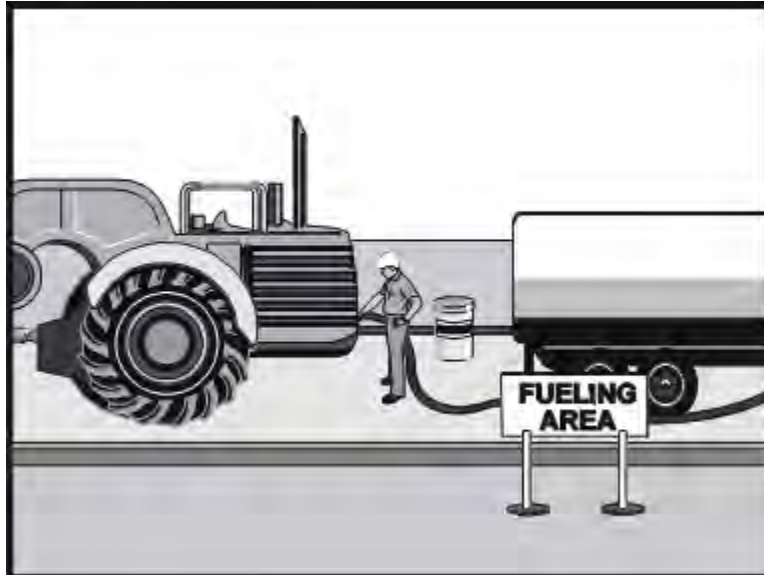

Description and Purpose

Vehicle equipment fueling procedures and practices are designed to prevent fuel spills and leaks, and reduce or eliminate contamination of storm water. This can be accomplished by using offsite facilities, fueling in designated areas only, enclosing or covering stored fuel, implementing spill controls, and training employees and subcontractors in proper fueling procedures.

Suitable Applications

These procedures are suitable on all construction sites where vehicle and equipment fueling takes place.

Limitations

Onsite vehicle and equipment fueling should only be used where it is impractical to send vehicles and equipment offsite for fueling. Sending vehicles and equipment offsite should be done in conjunction with TR-1, Stabilized Construction Entrance/Exit.

Implementation

- Use offsite fueling stations as much as possible. These businesses are better equipped to handle fuel and spills properly. Performing this work offsite can also be economical by eliminating the need for a separate fueling area at a site.
- Discourage “topping-off” of fuel tanks.
- Absorbent spill cleanup materials and spill kits should be available in fueling areas and on fueling trucks, and should be disposed of properly after use.

Objectives

- EC – Erosion Control
- SE – Sediment Control
- TR – Tracking Control
- WE – Wind Erosion Control
- NS – Non-Storm Water Management Control ✓
- WM – Waste Management & Materials Pollution Control

Legend:

- ✓ Primary Objective
- ▲ Secondary Objective

Targeted Constituents

- Sediment
- Nutrients
- Trash
- Metals
- Bacteria
- Oil and Grease ✓
- Organics

Potential Alternatives

None

- Drip pans or absorbent pads should be used during vehicle and equipment fueling, unless the fueling is performed over an impermeable surface in a dedicated fueling area.
- Use absorbent materials on small spills. Do not hose down or bury the spill. Remove the adsorbent materials promptly and dispose of properly.
- Avoid mobile fueling of mobile construction equipment around the site; rather, transport the equipment to designated fueling areas. With the exception of tracked equipment such as bulldozers and large excavators, most vehicles should be able to travel to a designated area with little lost time.
- Train employees and subcontractors in proper fueling and cleanup procedures.
- When fueling must take place onsite, designate an area away from drainage courses to be used. Fueling areas should be identified in the site-specific BMPs plan.
- Dedicated fueling areas should be protected from storm water runoff and runoff, and should be located at least 50 ft. away from downstream drainage facilities and watercourses. Fueling must be performed on level-grade areas.
- Protect fueling areas with berms and dikes to prevent runoff, runoff, and to contain spills.
- Nozzles used in vehicle and equipment fueling should be equipped with an automatic shutoff to control drips. Fueling operations should not be left unattended.
- Use vapor recovery nozzles to help control drips as well as air pollution.
- Federal, state, and local requirements should be observed for any stationary above ground storage tanks.

Costs

- All of the above measures are low cost except for the capital costs of above ground tanks that meet all local environmental, zoning, and fire codes.

Inspection and Maintenance

- Vehicles and equipment should be inspected each day of use for leaks. Leaks should be repaired immediately or problem vehicles or equipment should be removed from the project site.
- Keep ample supplies of spill cleanup materials onsite.
- Immediately clean up spills and properly dispose of contaminated soil and cleanup materials.

References

Blueprint for a Clean Bay: Best Management Practices to Prevent Stormwater Pollution from Construction Related Activities; Santa Clara Valley Nonpoint Source Pollution Control Program, 1995.

California Stormwater Quality Association (CASQA) Best Management Practices Handbook Construction, 2003.

Coastal Nonpoint Pollution Control Program: Program Development and Approval Guidance, Working Group Working Paper; USEPA, April 1992.

Stormwater Management for Construction Activities, Developing Pollution Prevention Plans and Best Management Practices, EPA 832-R-92005; USEPA, April 1992.

Stormwater Quality Handbooks - Construction Site Best Management Practices (BMPs) Manual, State of California Department of Transportation (Caltrans), November 2000.

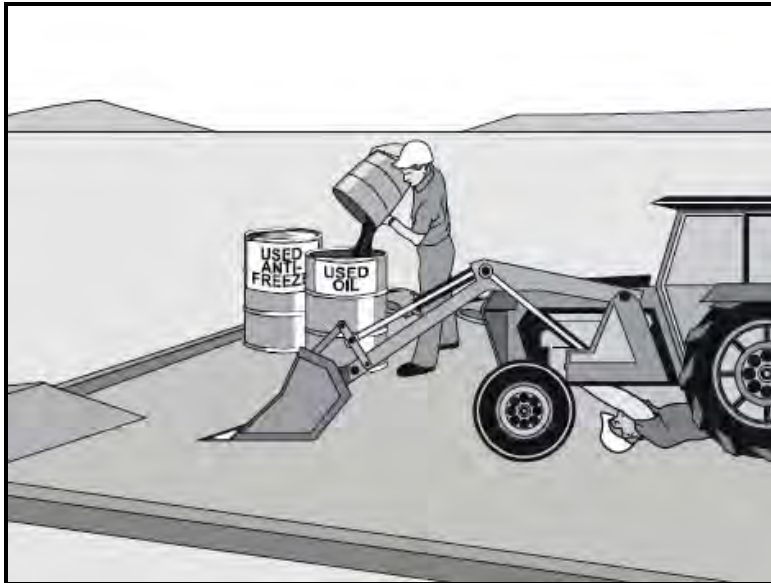

Description and Purpose

Prevent or reduce the contamination of storm water resulting from vehicle and equipment maintenance by running a “dry and clean site”. The best option would be to perform maintenance activities at an offsite facility. If this option is not available then work should be performed in designated areas only, while providing cover for materials stored outside, checking for leaks and spills, and containing and cleaning up spills immediately. Employees and subcontractors must be trained in proper procedures.

Suitable Applications

These procedures are suitable on all construction projects where an onsite yard area is necessary for storage and maintenance of heavy equipment and vehicles.

Limitations

Onsite vehicle and equipment maintenance should only be used where it is impractical to send vehicles and equipment offsite for maintenance and repair. Sending vehicles/equipment offsite should be done in conjunction with TR-1, Stabilized Construction Entrance/Exit.

Outdoor vehicle or equipment maintenance is a potentially significant source of storm water pollution. Activities that can contaminate storm water include engine repair and service, changing or replacement of fluids, and outdoor equipment storage and parking (engine fluid leaks). For further information on vehicle or equipment servicing, see NS-8, Vehicle and Equipment Cleaning, and NS-9, Vehicle and Equipment Fueling.

Objectives

- EC – Erosion Control
- SE – Sediment Control
- TR – Tracking Control
- WE – Wind Erosion Control
- NS – Non-Storm Water Management Control ✓
- WM – Waste Management & Materials Pollution Control

Legend:

- ✓ Primary Objective
- ▲ Secondary Objective

Targeted Constituents

- Sediment
- Nutrients ✓
- Trash ✓
- Metals
- Bacteria
- Oil and Grease ✓
- Organics ✓

Potential Alternatives

None

Implementation

- Use offsite repair shops as much as possible. These businesses are better equipped to handle vehicle fluids and spills properly. Performing this work offsite can also be economical by eliminating the need for a separate maintenance area.
- If maintenance must occur onsite, use designated areas, located away from drainage courses. Dedicated maintenance areas should be protected from storm water runoff and runoff, and should be located at least 50 ft. from downstream drainage facilities and watercourses.
- Drip pans or absorbent pads should be used during vehicle and equipment maintenance work that involves fluids, unless the maintenance work is performed over an impermeable surface in a dedicated maintenance area.
- Place a stockpile of spill cleanup materials where it will be readily accessible.
- All fueling trucks and fueling areas are required to have spill kits and/or use other spill protection devices.
- Use adsorbent materials on small spills. Remove the absorbent materials promptly and dispose of properly.
- Inspect onsite vehicles and equipment daily at startup for leaks, and repair immediately.
- Keep vehicles and equipment clean; do not allow excessive build-up of oil and grease.
- Segregate and recycle wastes, such as greases, used oil or oil filters, antifreeze, cleaning solutions, automotive batteries, hydraulic and transmission fluids. Provide secondary containment and covers for these materials if stored onsite.
- Train employees and subcontractors in proper maintenance and spill cleanup procedures.
- Drip pans or plastic sheeting should be placed under all vehicles and equipment placed on docks, barges, or other structures over water bodies when the vehicle or equipment is planned to be idle for more than 1 hour.
- For long-term projects, consider using portable tents or covers over maintenance areas if maintenance cannot be performed offsite.
- Consider use of new, alternative greases and lubricants, such as adhesive greases, for chassis lubrication and fifth-wheel lubrication.
- Properly dispose of used oils, fluids, lubricants, and spill cleanup materials.
- Do not place used oil in a dumpster or pour into a storm drain or watercourse.
- Properly dispose of or recycle used batteries.
- Do not bury used tires.
- Repair leaks of fluids and oil immediately.

Listed below is further information if you must perform vehicle or equipment maintenance onsite.

Safer Alternative Products

- Consider products that are less toxic or hazardous than regular products. These products are often sold under an “environmentally friendly” label.
- Consider use of grease substitutes for lubrication of truck fifth-wheels. Follow manufacturers label for details on specific uses.

- Consider use of plastic friction plates on truck fifth-wheels in lieu of grease. Follow manufacturers label for details on specific uses.

Waste Reduction

Parts are often cleaned using solvents such as trichloroethylene, trichloroethane, or methylene chloride. Many of these cleaners are listed in HAR, Title 11, Chapter 261, Hazardous Waste Management Identification and Listing of Hazardous Waste as pollutants. These materials are harmful and must not contaminate storm water. They must be disposed of as a hazardous waste. Reducing the number of solvents makes recycling easier and reduces hazardous waste management costs. Often, one solvent can perform a job as well as two different solvents. Also, if possible, eliminate or reduce the amount of hazardous materials and waste by substituting non-hazardous or less hazardous materials. For example, replace chlorinated organic solvents with non-chlorinated solvents. Non-chlorinated solvents like kerosene or mineral spirits are less toxic and less expensive to dispose of properly. Check the list of active ingredients to see whether it contains chlorinated solvents. The “chlor” term indicates that the solvent is chlorinated. Also, try substituting a wire brush for solvents to clean parts.

Recycling and Disposal

Separating wastes allows for easier recycling and may reduce disposal costs. Keep hazardous wastes separate, do not mix used oil solvents, and keep chlorinated solvents (like, trichloroethane) separate from non-chlorinated solvents (like kerosene and mineral spirits). Promptly transfer used fluids to the proper waste or recycling drums. Don't leave full drip pans or other open containers lying around. Provide cover and secondary containment until these materials can be removed from the site.

Oil filters can be recycled. Ask your oil supplier or recycler about recycling oil filters.

Do not dispose of extra paints and coatings by dumping liquid onto the ground or throwing it into dumpsters. Allow coatings to dry or harden before disposal into covered dumpsters.

Store cracked batteries in a non-leaking secondary container. Do this with all cracked batteries, even if you think all the acid has drained out. If you drop a battery, treat it as if it is cracked. Put it into the containment area until you are sure it is not leaking.

Costs

All of the above are low cost measures. Higher costs are incurred to setup and maintain onsite maintenance areas.

Inspection and Maintenance

- Inspect and verify that activity-based BMPs are in place prior to the commencement of associated activities. While activities associated with the BMP are under way, inspect weekly during the rainy season and at two-week intervals in the non-rainy season to verify continued BMP implementation.
- Inspect BMPs subject to non-storm water discharges daily while non-storm water discharges occur.
- Keep ample supplies of spill cleanup materials onsite.
- Maintain waste fluid containers in leak proof condition.

- Vehicles and equipment should be inspected on each day of use. Leaks should be repaired immediately or the problem vehicle(s) or equipment should be removed from the project site.
- Inspect equipment for damaged hoses and leaky gaskets routinely. Repair or replace as needed.

References

Blueprint for a Clean Bay: Best Management Practices to Prevent Stormwater Pollution from Construction Related Activities; Santa Clara Valley Nonpoint Source Pollution Control Program, 1995.

California Stormwater Quality Association (CASQA) Best Management Practices Handbook Construction, 2003.

Coastal Nonpoint Pollution Control Program; Program Development and Approval Guidance, Working Group, Working Paper; USEPA, April 1992.

Hawaii Administrative Rules, Title 11, Chapter 54, Water Quality Standards.

Hawaii Administrative Rules, Title 11, Chapter 261, Hazardous Waste management Identification and Listing of Hazardous Waste.

Stormwater Quality Handbooks - Construction Site Best Management Practices (BMPs) Manual, State of California Department of Transportation (Caltrans), November 2000.

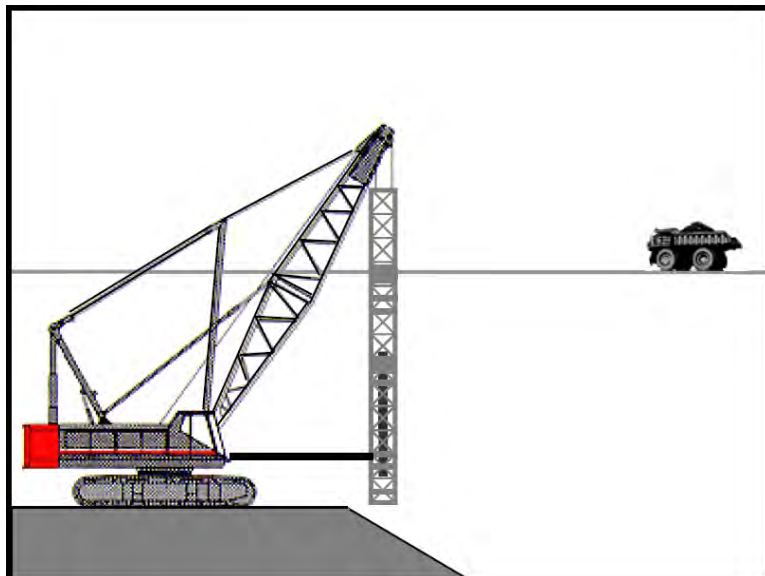

Description and Purpose

The construction and retrofit of bridges and retaining walls often include driving piles for foundation support and shoring operations. Driven piles are typically constructed of precast concrete, steel, or timber. Driven sheet piles are also used for shoring and cofferdam construction. Proper control and use of equipment, materials, and waste products from pile driving operations will reduce or eliminate the discharge of potential pollutants to the storm drain system, watercourses, and waters of the United States.

Suitable Applications

These procedures apply to all construction sites near or adjacent to a watercourse or groundwater where permanent and temporary pile driving (impact and vibratory) takes place, including operations using pile shells as well as construction of cast-in-steel-shell and cast-in-drilled-hole piles.

Limitations

None identified.

Implementation

- Use drip pans or absorbent pads during vehicle and equipment operation, maintenance, cleaning, fueling, and storage. Refer to NS-8, Vehicle and Equipment Cleaning, NS-9, Vehicle and Equipment Fueling, and NS-10, Vehicle and Equipment Maintenance.

Objectives

- EC – Erosion Control
- SE – Sediment Control
- TR – Tracking Control
- WE – Wind Erosion Control
- NS – Non-Storm Water Management Control ✓
- WM – Waste Management & Materials Pollution Control

Legend:

- ✓ Primary Objective
- ▲ Secondary Objective

Targeted Constituents

- Sediment ✓
- Nutrients
- Trash
- Metals
- Bacteria
- Oil and Grease ✓
- Organics

Potential Alternatives

None

- Have spill kits and cleanup materials available at all locations of pile driving. Refer to WM-4, Spill Prevention and Control.
- Have spill kits and cleanup materials available at all locations of pile driving. Refer to WM- 4, Spill Prevention and Control.
- Equipment that is stored or in use in streambeds, or on docks, barges, or other structures over water bodies should be kept leak free.
- Park equipment over plastic sheeting or equivalent where possible. Plastic is not a substitute for drip pans or absorbent pads. The storage or use of equipment in streambeds or other bodies of water must comply with all applicable permits.
- Implement other BMPs as applicable, such as NS-2, Dewatering Operations, WM-5, Solid Waste Management, WM-6, Hazardous Waste Management, and WM-10, Liquid Waste Management.
- When not in use, store pile-driving equipment away from concentrated flows of storm water, drainage courses, and inlets. Protect hammers and other hydraulic attachments from runoff and runoff by placing them on plywood and covering them with plastic or a comparable material prior to the onset of rain.
- Use less hazardous products, e.g., vegetable oil, when practicable.

Costs

All of the above measures can be low cost.

Inspection and Maintenance

- Inspect and verify that activity-based BMPs are in place prior to the commencement of associated activities. While activities associated with the BMP are under way, inspect weekly during the rainy season and at two-week intervals in the non-rainy season to verify continued BMP implementation.
- Inspect BMPs subject to non-storm water discharges daily while non-storm water discharges occur.
- Inspect equipment every day at startup and repair equipment as needed (i.e., worn or damaged hoses, fittings, and gaskets). Recheck equipment at shift changes or at the end of the day and scheduled repairs as needed.

References

California Stormwater Quality Association (CASQA) Best Management Practices Handbook Construction, 2003.

Stormwater Management for Construction Activities, Developing Pollution Prevention Plans and Best Management Practices, EPA 832-R-92005; USEPA, April 1992.

Stormwater Quality Handbooks - Construction Site Best Management Practices (BMPs) Manual, State of California Department of Transportation (Caltrans), November 2000.

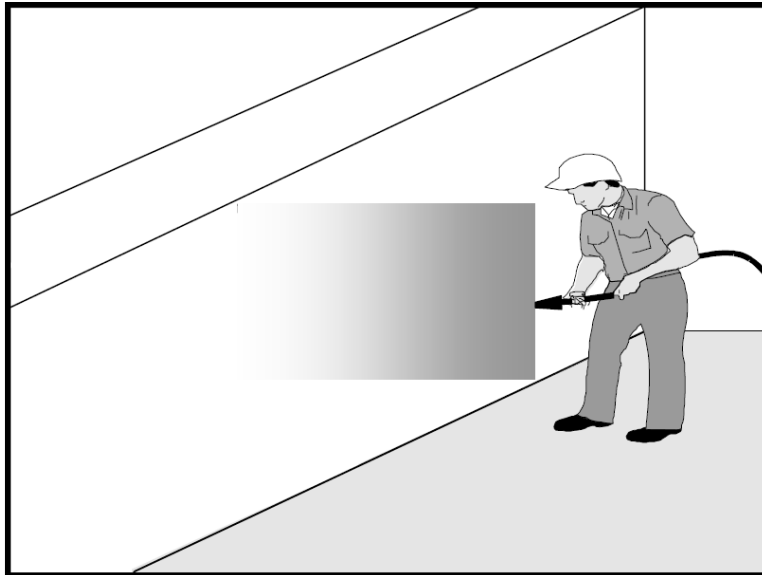

Description and Purpose

Concrete curing is used in the construction of structures such as bridges, retaining walls, pump houses, large slabs, and structured foundations. Concrete curing includes the use of both chemical and water methods. Discharges of storm water and non-storm water exposed to concrete during curing may have a high pH and may contain chemicals, metals, and fines. Proper procedures reduce or eliminate the contamination of storm water runoff during concrete curing.

Suitable Applications

Suitable applications include all projects where Portland Cement Concrete (PCC) and concrete curing chemicals are placed where they can be exposed to rainfall, runoff from other areas, or where runoff from the PCC will leave the site.

Limitations

None identified.

Implementation

Chemical Curing

- Avoid over spray of curing compounds.
- Minimize the drift of chemical cure as much as possible by applying the curing compound close to the concrete surface. Apply an amount of compound that covers the surface, but does not allow any runoff of the compound.
- Use proper storage and handling techniques for concrete curing compounds. Refer to WM-1, Material Delivery and Storage.

Objectives

- EC – Erosion Control
- SE – Sediment Control
- TR – Tracking Control
- WE – Wind Erosion Control
- NS – Non-Storm Water Management Control ✓
- WM – Waste Management & Materials Pollution Control

Legend:

- ✓ Primary Objective
- ▲ Secondary Objective

Targeted Constituents

- Sediment
- Nutrients ✓
- Trash
- Metals ✓
- Bacteria
- Oil and Grease ✓
- Organics

Potential Alternatives

None

- Protect drain inlets prior to the application of curing compounds.
- Refer to WM-4, Spill Prevention and Control.

Water Curing for Bridge Decks, Retaining Walls, and other Structures

- Direct cure water away from inlets and watercourses to collection areas for infiltration or other means of removal in accordance with all applicable permits.
- Collect cure water at the top of slopes and transport or dispose of water in a non-erodible manner. See EC-9 Earth Dikes and Drainage Swales, EC-10, Velocity Dissipation Devices, and EC-11, Slope Drains.
- Utilize wet blankets or a similar method that maintains moisture while minimizing the use and possible discharge of water.

Costs

All of the above measures are generally low cost.

Inspection and Maintenance

- Inspect and verify that activity-based BMPs are in place prior to the commencement of associated activities. While activities associated with the BMP are under way, inspect weekly during the rainy season and at two-week intervals in the non-rainy season to verify continued BMP implementation.
- Inspect BMPs subject to non-storm water discharges daily while non-storm water discharges occur.
- Ensure that employees and subcontractors implement appropriate measures for storage, handling, and use of curing compounds.
- Inspect cure containers and spraying equipment for leaks.

References

Blue Print for a Clean Bay-Construction-Related Industries: Best Management Practices for Stormwater Pollution Prevention; Santa Clara Valley Non Point Source Pollution Control Program, 1992.

California Stormwater Quality Association (CASQA) Best Management Practices Handbook Construction, 2003.

Stormwater Management for Construction Activities, Developing Pollution Prevention Plans and Best Management Practices, EPA 832-R-92005; USEPA, April 1992.

Stormwater Quality Handbooks - Construction Site Best Management Practices (BMPs) Manual, State of California Department of Transportation (Caltrans), November 2000.

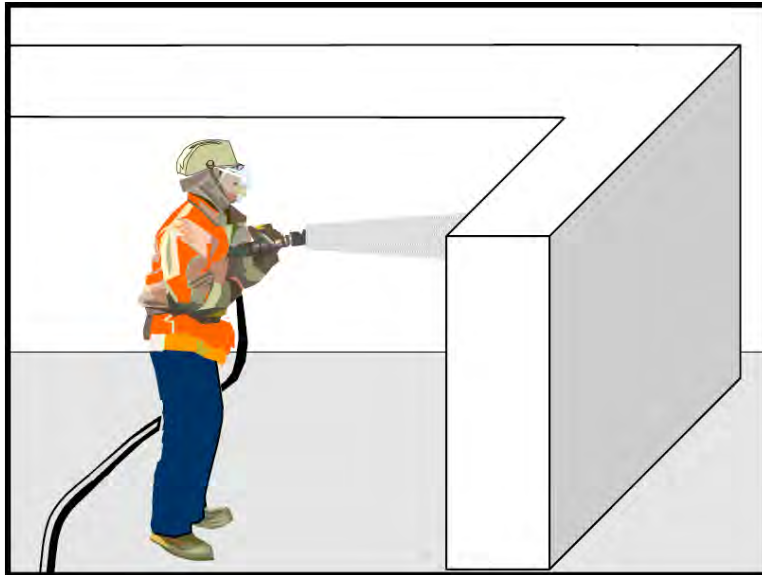

Description and Purpose

Concrete finishing methods are used for bridge deck rehabilitation, paint removal, curing compound removal, and final surface finish appearances. Methods include sand blasting, shot blasting, grinding, or high pressure water blasting. Storm water and non-storm water exposed to concrete finishing by-products may have a high pH and may contain chemicals, metals, and fines. Proper procedures and implementation of appropriate BMPs can minimize the impact that concrete-finishing methods may have on storm water and non-storm water discharges.

Suitable Applications

These procedures apply to all construction locations where concrete finishing operations are performed.

Limitations

None identified.

Implementation

Collect and properly dispose of water from high-pressure water blasting operations.

Collect contaminated water from blasting operations at the top of slopes. Transport or dispose of contaminated water while using BMPs such as those for erosion control. Refer to EC-9, Earth Dikes and Drainage Swales, EC-10, Velocity Dissipation Devices, and EC-11, Slope Drains.

Objectives

- EC – Erosion Control
- SE – Sediment Control
- TR – Tracking Control
- WE – Wind Erosion Control
- NS – Non-Storm Water Management Control ✓
- WM – Waste Management & Materials Pollution Control ✓

Legend:

- ✓ Primary Objective
- ▲ Secondary Objective

Targeted Constituents

- Sediment
- Nutrients ✓
- Trash
- Metals ✓
- Bacteria
- Oil and Grease
- Organics ✓

Potential Alternatives

None

- Direct water from blasting operations away from inlets and watercourses to collection areas for infiltration or other means of removal (dewatering). Refer to NS-2 Dewatering Operations.
- Protect inlets during sandblasting operations. Refer to SE-10, Storm Drain Inlet Protection.
- Refer to WM-8, Concrete Waste Management for disposal of concrete based debris.
- Minimize the drift of dust and blast material as much as possible by keeping the blasting nozzle close to the surface.
- When blast residue contains a potentially hazardous waste, refer to WM-6, Hazardous Waste Management.

Costs

These measures are generally of low cost.

Inspection and Maintenance

- Inspect and verify that activity-based BMPs are in place prior to the commencement of associated activities. While activities associated with the BMP are under way, inspect weekly during the rainy season and at two-week intervals in the non-rainy season to verify continued BMP implementation.
- Inspect BMPs subject to non-storm water discharges daily while non-storm water discharges occur.
- Sweep or vacuum up debris from sandblasting at the end of each shift.
- At the end of each work shift, remove and contain liquid and solid waste from containment structures, if any, and from the general work area.

References

Blueprint for a Clean Bay: Best Management Practices to Prevent Stormwater Pollution from Construction Related Activities; Santa Clara Valley Nonpoint Source Pollution Control Program, 1995.

California Stormwater Quality Association (CASQA) Best Management Practices Handbook Construction, 2003.

Stormwater Management for Construction Activities, Developing Pollution Prevention Plans and Best Management Practices, EPA 832-R-92005; USEPA, April 1992.

Stormwater Quality Handbooks - Construction Site Best Management Practices (BMPs) Manual, State of California Department of Transportation (Caltrans), November 2000.

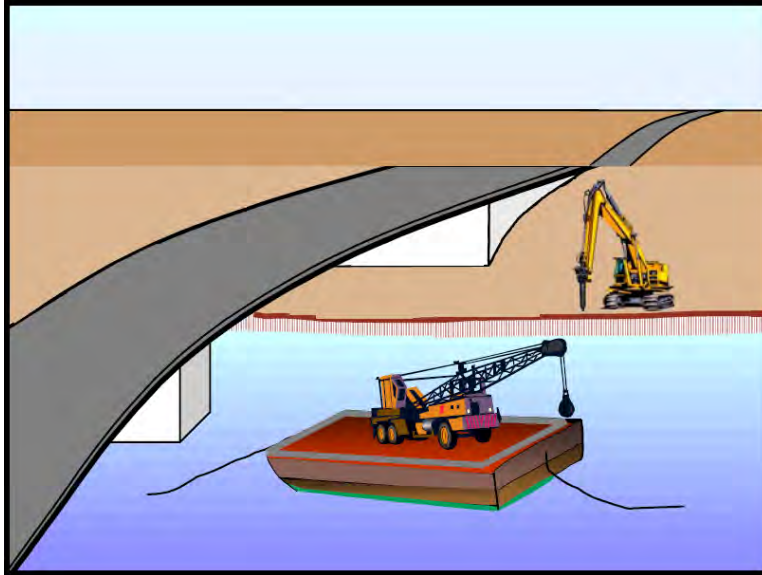

Description and Purpose

Procedures for the proper use, storage, and disposal of materials and equipment on barges, boats, temporary construction pads, or similar locations, that minimize or eliminate the discharge of potential pollutants to a watercourse.

Suitable Applications

Applies where materials and equipment are used on barges, boats, docks, and other platforms over or adjacent to a watercourse including waters of the United States. These procedures should be implemented for construction materials and wastes (solid and liquid), soil or dredging materials, or any other materials that may cause or contribute to exceedences of water quality standards.

Limitations

Dredge and fill activities are regulated by the US Army Corps of Engineers and State of Hawaii Department of Health, Clean Water Branch (CWB) under Section 404/401 of the Clean Water Act.

Implementation

- Refer to WM-1, Material Delivery and Storage and WM-4, Spill Prevention and Control.
- Use drip pans and absorbent materials for equipment and vehicles and ensure that an adequate supply of spill cleanup materials is available.
- Drip pans should be placed under all vehicles and equipment placed on docks, barges, or other structures over water bodies when the vehicle or equipment is expected to be idle for more than 1 hour.

Objectives

- EC – Erosion Control
- SE – Sediment Control
- TR – Tracking Control
- WE – Wind Erosion Control
- NS – Non-Storm Water Management Control ✓
- WM – Waste Management & Materials Pollution Control ✓

Legend:

- ✓ Primary Objective
- ▲ Secondary Objective

Targeted Constituents

- Sediment ✓
- Nutrients ✓
- Trash ✓
- Metals ✓
- Bacteria ✓
- Oil and Grease ✓
- Organics ✓

Potential Alternatives

None

- Maintain equipment in accordance with NS-10, Vehicle and Equipment Maintenance. If a leaking line cannot be repaired, remove equipment from over the water.
- Provide watertight curbs or toe boards to contain spills and prevent materials, tools, and debris from leaving the barge, platform, dock, etc.
- Provide sediment control BMPs for openings on top of bridges.
- Secure all materials to prevent discharges to receiving waters via wind.
- Identify types of spill control measures to be employed, including the storage of such materials and equipment. Ensure that staff is trained regarding the use of the materials, deployment and access of control measures, and reporting measures.
- In case of spills, contact the local emergency response by dialing 911 as soon as possible but within 48 hours. See WM-4 Spill Prevention and Control for more information.
- Refer to WM-5, Solid Waste Management (non-hazardous) and WM-6, Hazardous Waste Management. Ensure the timely and proper removal of accumulated wastes.
- Comply with all necessary permits required for construction within or near the watercourse, such as CWB and U.S. Army Corps of Engineers.
- Discharges to waterways should be reported to the CWB immediately upon discovery. A written discharge notification must follow within 7 days. Follow the spill reporting procedures contained in site-specific BMPs plan.

Costs

These measures are generally of low to moderate cost. Exceptions are areas for temporary storage of materials, engine fluids, or wastewater pump out.

Inspection and Maintenance

- Inspect and verify that activity-based BMPs are in place prior to the commencement of associated activities. While activities associated with the BMP are under way, inspect weekly during the rainy season and of two-week intervals in the non-rainy season to verify continued BMP implementation.
- Inspect BMPs subject to non-storm water discharge daily while non-storm water discharges occur.
- Ensure that employees and subcontractors implement the appropriate measures for storage and use of materials and equipment.
- Inspect and maintain all associated BMPs and perimeter controls to ensure continuous protection of the water courses, including waters of the United States.

References

California Stormwater Quality Association (CASQA) Best Management Practices Handbook Construction, 2003.

Hawaii Administrative Rules, Title 11, Chapter 54, Water Quality Standards.

Section 404 of the Clean Water Act.

Stormwater Management for Construction Activities, Developing Pollution Prevention Plans and Best Management Practices, EPA 832-R-92005; USEPA, April 1992.

Stormwater Quality Handbooks - Construction Site Best Management Practices (BMPs) Manual, State of California Department of Transportation (Caltrans), November 2000.

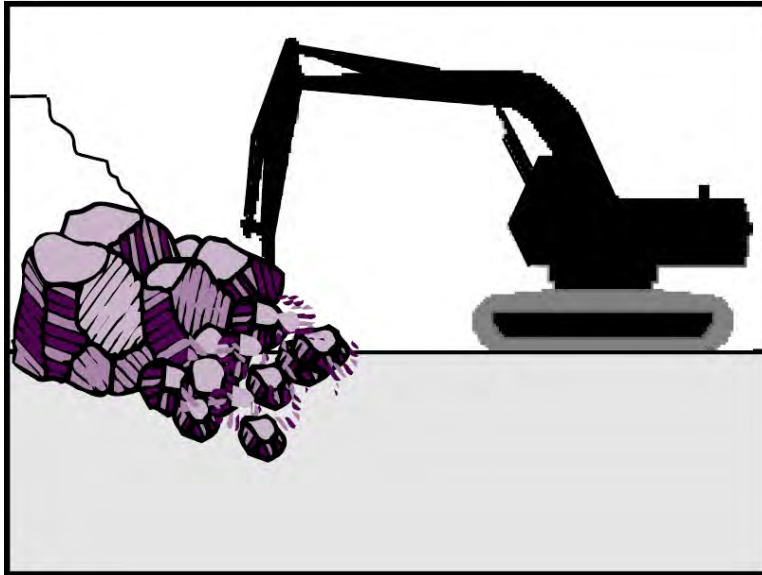

Description and Purpose

Procedures to protect water bodies from debris and wastes associated with structure demolition or removal over or adjacent to watercourses.

Suitable Applications

Full bridge demolition and removal, partial bridge removal (barrier rail, edge of deck) associated with bridge widening projects, concrete channel removal, or any other structure removal that could potentially affect water quality.

Limitations

None identified.

Implementation

- Provide sediment control BMPs for the upland construction activities at bridges.
- Refer to NS-5, Clear Water Diversion, to direct water away from work areas.
- Use attachments on construction equipment such as backhoes to catch debris from small demolition operations.
- Use covers or platforms to collect debris.
- Platforms and covers are to be approved by the owner.
- Stockpile accumulated debris and waste generated during demolition away from watercourses and in accordance with WM-3, Stockpile Management.
- Ensure safe passage of wildlife, as necessary.

Objectives

- EC – Erosion Control
- SE – Sediment Control
- TR – Tracking Control
- WE – Wind Erosion Control
- NS – Non-Storm Water Management Control ✓
- WM – Waste Management & Materials Pollution Control

Legend:

- ✓ Primary Objective
- ▲ Secondary Objective

Targeted Constituents

Sediment	✓
Nutrients	✓
Trash	✓
Metals	✓
Bacteria	✓
Oil and Grease	✓
Organics	✓

Potential Alternatives

None

- Discharges to waterways shall be reported to the State of Hawaii Department of Health, Clean Water Branch (CWB) immediately upon discovery. A written discharge notification must follow within 7 days. Follow the spill reporting procedures in the site-specific BMPs plan.
- For structures containing hazardous materials, i.e., lead paint or asbestos, refer to BMP WM-6, Hazardous Waste Management. For demolition work involving soil excavation around lead-painted structures, refer to WM-7, Contaminated Soil Management.

Costs

Cost may vary according to the combination of practices implemented.

Inspection and Maintenance

- Inspect and verify that activity-based BMPs are in place prior to the commencement of associated activities. While activities associated with the BMP are under way, inspect weekly during the rainy season and of two-week intervals in the non-rainy season to verify continued BMP implementation.
- Inspect BMPs subject to non-storm water discharge daily while non-storm water discharges occur.
- Any debris-catching devices shall be emptied regularly. Collected debris shall be removed and stored away from the watercourse and protected from runoff and runoff.

References

California Stormwater Quality Association (CASQA) Best Management Practices Handbook Construction, 2003.

Hawaii Administrative Rules, Title 11, Chapter 54, Water Quality Standards.

Stormwater Management for Construction Activities, Developing Pollution Prevention Plans and Best Management Practices, EPA 832-R-92005; USEPA, April 1992.

Stormwater Quality Handbooks - Construction Site Best Management Practices (BMPs) Manual, State of California Department of Transportation (Caltrans), November 2000.



Description and Purpose

The construction of roads, bridges, retaining walls, and other large structures in remote areas, often requires temporary batch plant facilities to manufacture Portland Cement Concrete (PCC) or asphalt cement (AC). Temporary batch plant facilities typically consist of silos containing fly ash, lime, and cement; heated tanks of liquid asphalt; sand and gravel material storage areas; mixing equipment; above ground storage tanks containing concrete additives and water; and designated areas for sand and gravel truck unloading, concrete truck loading, and concrete truck washout. Proper control and use of equipment, materials, and waste products from temporary batch plant facilities will reduce the discharge of potential pollutants to the storm drain system or watercourses, reduce air emissions, and mitigate noise impacts.

Suitable Applications

These procedures typically apply to construction sites where temporary batch plant facilities are used.

Limitations

The General Permit for discharges of storm water associated with industrial activities may be applicable to temporary batch plants. Rock crushing activities require an individual industrial activities NPDES permit for the State of Hawaii.

Specific permit requirements or mitigation measures such as State of Hawaii Department of Health, Clean Air Branch (CAB), State of Hawaii Department of Health, Clean Water Branch (CWB), county ordinances and city ordinances may require alternative mitigation measures for temporary batch plants.

Objectives

- EC – Erosion Control
- SE – Sediment Control
- TR – Tracking Control
- WE – Wind Erosion Control
- NS – Non-Storm Water Management Control ✓
- WM – Waste Management & Materials Pollution Control

Legend:

- ✓ Primary Objective
- ▲ Secondary Objective

Targeted Constituents

- Sediment ✓
- Nutrients
- Trash ✓
- Metals ✓
- Bacteria
- Oil and Grease
- Organics

Potential Alternatives

None

Implementation

Planning

Implementation steps are as follows:

- Large scale temporary batch plants may be subject to the General Industrial NPDES permit – contact CWB for determination. If batch plant is classified as an industrial facility by CWB, a Notice of Intent (NOI) Form B must be submitted to the CWB;
- Proper planning, design, and construction of temporary batch plants should be implemented to minimize potential water quality, air pollution, and noise impacts associated with temporary batch plants;
- BMPs and a Sampling and Analysis Plan (SAP) must be included in the project site-specific BMPs plan. BMPs must be implemented, inspected, and maintained;
- Temporary batch plants should be managed to comply with CWB requirements;
- Construct temporary batch plants down-wind of existing developments whenever possible; and
- Placement of access roads should be planned to mitigate water and air quality impacts.

Layout and Design

- Temporary batch plants should be properly located and designed to mitigate water quality impacts to receiving water bodies. Batch plants should be located away from watercourses, drainage courses, and drain inlets. Batch plants should be located to minimize the potential for storm water runoff onto the site.
- Temporary batch plant facilities (including associated stationary equipment and stockpiles) should be located at least 300 ft. from any recreational area, school, residence, or other structure not associated with the construction project.
- Construct continuous interior AC or PCC berms around batch plant equipment (mixing equipment, silos, concrete drop points, conveyor belts, admixture tanks, etc.) to facilitate proper containment and cleanup of releases. Rollover or flip top curb or dikes should be placed at ingress and egress points.
- Direct runoff from the paved or unpaved portion of the batch plant into a sump and pipe to a lined washout area or dewatering tank.
- Direct storm water and non-storm water runoff from unpaved portions of batch plant facility to catchment ponds or tanks.
- Construct and remove concrete washout facilities in accordance with WM-8, Concrete Waste Management.
- Layout of a typical batch plant and associated BMP is located at the end of this BMP fact sheet.

Operational Procedures

- Washout of concrete trucks should be conducted in a designated area in accordance with WM-8, Concrete Waste Management.
- Do not dispose of concrete into drain inlets, the storm water drainage system, or watercourses.

- Equipment washing should occur in a designated area in accordance with WM-8, Concrete Waste Management. Washing equipment, tools, or vehicles to remove PCC shall be conducted in accordance with NS-7, Potable Water/Irrigation, and NS-8, Vehicle and Equipment Cleaning.
- All dry material transfer points should be ducted through a fabric or cartridge type filter unless there are no visible emissions from the transfer point.
- Equip all bulk storage silos, including auxiliary bulk storage trailers, with fabric or cartridge type filter(s).
- Maintain silo vent filters in proper operating condition.
- Equip silos and auxiliary bulk storage trailers with dust-tight service hatches.
- Fabric dust collection system should be capable of controlling 99 percent of the particulate matter.
- Fabric dust collectors (except for vent filters) should be equipped with an operational pressure differential gauge to measure the pressure drop across the filters.
- All transfer points should be equipped with a wet suppression system to control fugitive particulate emissions unless there are no visible emissions.
- All conveyors should be covered, unless the material being transferred results in no visible emissions.
- There should be no visible emissions beyond the property line, while the equipment is being operated.
- Collect dust emissions from the loading of open-bodied trucks at the drip point of dry batch plants, or dust emissions from the drum feed for central mix plants.
- Equip silos and auxiliary bulk storage trailers with a visible and/or audible warning mechanism to warn operators that the silo or trailer is full.
- All open-bodied vehicles transporting material should be loaded with a final layer of wet sand and the truck shall be covered with a tarp to reduce emissions.

Tracking Control

- Plant roads (batch truck and material delivery truck roads) and areas between stockpiles and conveyor hoppers should be stabilized (TR-2, Stabilized Construction Roadway), watered (WE-1, Wind Erosion Control), treated with dust-suppressant chemicals, or paved with a cohesive hard surface that can be repeatedly swept, maintained intact, and cleaned as necessary to control dust emissions.
- Trucks should not track PCC from plants onto public roads. Use appropriate practices from TR-1, Stabilized Construction Entrance/Exit to prevent tracking.

Materials Storage

- WM-1, Material Delivery and Storage, should be implemented at all batch plants using concrete components or compounds. An effective strategy is to cover and contain materials.
- WM-2, Material Use should be conducted in a way to minimize or eliminate the discharge of materials to storm drain system or watercourse.

- Ensure that finer materials are not dispersed into the air during operations, such as unloading of cement delivery trucks.
- Stockpiles should be covered and enclosed with perimeter sediment barriers per WM-3, Stockpile Management. Uncovered stockpiles should be sprinkled with water and/or dust suppressant chemicals as necessary to control dust emissions, unless the stockpiled material results in no visible emissions. An operable stockpile watering system should be onsite at all times.
- Store bagged and boxed materials on pallets and cover on non-working days prior to rain.
- Minimize stockpiles of demolished PCC by recycling them in a timely manner.
- Provide secondary containment for liquid materials (WM-1). Containment should provide sufficient volume to contain precipitation from a 25-year storm plus 10% of the aggregate volume of all containers or plus 100% of the largest container, whichever is greater.
- Handle solid and liquid waste in accordance with WM-5, Solid Waste Management, WM-10, Liquid Waste Management, and WM-8, Concrete Waste Management.
- Maintain adequate supplies of spill cleanup materials and train staff to respond to spills per WM-4, Spill Prevention and Control.
- Immediately clean up spilled cement and fly ash and contain or dampen so that dust or emissions from wind erosion or vehicle traffic are minimized.

Equipment Maintenance

- Equipment should be maintained to prevent fluid leaks and spills per NS-9, Vehicle and Equipment Fueling, and NS-10, Vehicle and Equipment Maintenance.
- Maintain adequate supplies of spill cleanup materials and train staff to respond to spills per WM-4, Spill Prevention and Control.
- Incorporate other BMPs such as WM-5, Solid Waste Management, WM-6, Hazardous Waste Management, and WM-10, Liquid Waste Management.

Costs

Costs will vary depending on the size of the facility and combination of BMPs implemented.

Inspection and Maintenance

- Inspect and verify that activity-based BMPs are in place prior to the commencement of associated activities. While activities associated with the BMP are under way, inspect weekly during the rainy season and of two-week intervals in the non-rainy season to verify continued BMP implementation.
- Inspect BMPs subject to non-storm water discharge daily while non-storm water discharges occur.
- Inspect and repair equipment (for damaged hoses, fittings, and gaskets).
- Inspect and maintain Stabilized Construction Entrance/Exit (TR-1) as needed.
- Inspect and maintain stabilized haul roads as needed.
- Inspect and maintain materials and waste storage areas as needed.

References

California Stormwater Quality Association (CASQA) Best Management Practices Handbook Construction, 2003.

Hawaii Administrative Rules, Title 11, Chapter 55, Water Pollution Control.

Hawaii Administrative Rules, Title 11, Chapter 60.1, Air Pollution Control.

Stormwater Management for Construction Activities, Developing Pollution Prevention Plans and Best Management Practices, EPA 832-R-92005; USEPA, April 1992.

Stormwater Quality Handbooks - Construction Site Best Management Practices (BMPs) Manual, State of California Department of Transportation (Caltrans), November 2000.

4.6 WASTE MANAGEMENT AND MATERIALS POLLUTION CONTROL FACT SHEETS

- WM-1 Material Delivery and Storage
- WM-2 Material Use
- WM-3 Stockpile Management
- WM-4 Spill Prevention and Control
- WM-5 Solid Waste Management
- WM-6 Hazardous Waste Management
- WM-7 Contaminated Soil Management
- WM-8 Concrete Waste Management
- WM-9 Sanitary/Septic Waste Management
- WM-10 Liquid Waste Management



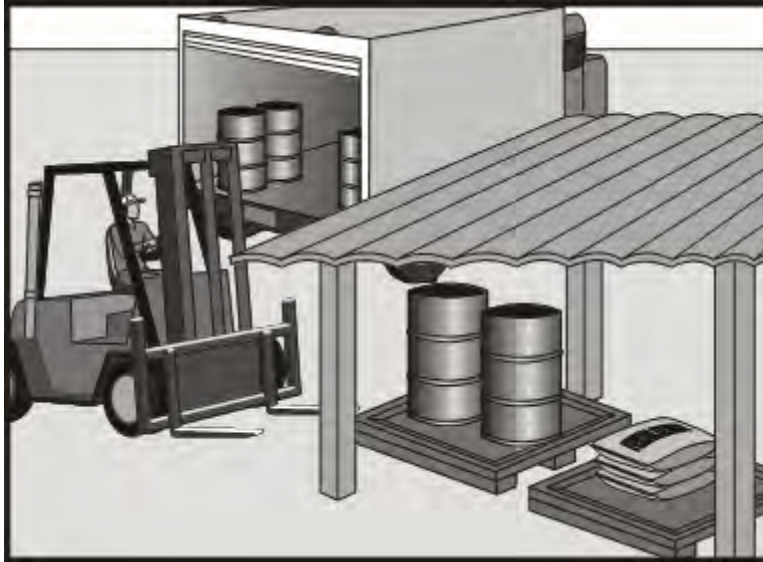

Description and Purpose

Prevent, reduce, or eliminate the discharge of pollutants from material delivery and storage to the storm water system or watercourses by minimizing the storage of hazardous materials onsite, storing materials in a designated area, installing secondary containment, conducting regular inspections, and training employees and subcontractors.

This best management practice covers only material delivery and storage. For other information on materials, see WM-2 Material Use, or WM-4 Spill Prevention and Control. For information on wastes, see the waste management BMPs in this section.

Suitable Applications

These procedures are suitable for use at all construction sites with delivery and storage of the following materials:

- Soil stabilizers and binders;
- Pesticides and herbicides;
- Fertilizers;
- Detergents;
- Plaster;
- Petroleum products such as fuel, oil, and grease. Note that spill prevention, control, and countermeasure (SPCC) plan are necessary if total above ground storage (AST) volume is equal to or greater than 1320 gallons (40 CFR 112.1 (d)(2)(ii)). See WM-4;
- Asphalt and concrete components;

Objectives

- EC – Erosion Control
- SE – Sediment Control
- TR – Tracking Control
- WE – Wind Erosion Control
- NS – Non-Storm Water Management Control ✓
- WM – Waste Management & Materials Pollution Control

Legend:

- ✓ Primary Objective
- ▲ Secondary Objective

Targeted Constituents

Sediment	✓
Nutrients	✓
Trash	✓
Metals	✓
Bacteria	
Oil and Grease	✓
Organics	✓

Potential Alternatives

None

- Hazardous chemicals such as acids, lime, glues, adhesives, paints, solvents, and curing compounds;
- Concrete compounds; and/or
- Other materials that may be detrimental if released to the environment.

Limitations

- Space limitation may preclude indoor storage.
- Storage sheds often must meet building and fire code requirements.

Implementation

The following steps should be taken to minimize risk:

- Temporary storage area should be located away from vehicular traffic;
- Material Safety Data Sheets (MSDS) should be supplied for all materials stored;
- Construction site areas should be designated for material delivery and storage;
- Material delivery and storage areas should be located near the construction entrances, away from waterways, if possible:
 - Avoid transport near drainage paths or waterways;
 - Surround with earth berms (See EC-9, Earth Dikes and Drainage Swales) or approved containment device; and
 - Place in an area which will be paved.
- Storage of reactive, ignitable, or flammable liquids must comply with the City and County of Honolulu fire codes. Contact the Honolulu Fire Department (HFD) to review site materials, quantities, and proposed storage area to determine specific requirements. See the Flammable and Combustible Liquid Code, NFPA30;
- An up to date inventory of materials delivered and stored onsite should be kept;
- Hazardous materials storage onsite should be minimized;
- Hazardous materials should be handled as infrequently as possible;
- During the rainy season, consider storing materials in a covered area. Store materials in secondary containments such as earthen dike, horse trough, or even a children's wading pool for non-reactive materials such as detergents, oil, grease, and paints. Small amounts of material may be secondarily contained in "bus boy" trays or concrete mixing trays;
- Do not store chemicals, drums, or bagged materials directly on the ground. Place these items on a pallet and, when possible, in secondary containment;
- If drums must be kept uncovered, store them at a slight angle to reduce ponding of rainwater on the lids to reduce corrosion. Domed plastic covers are inexpensive and snap to the top of drums, preventing water from collecting;
- Chemicals should be kept in their original labeled containers;
- Employees and subcontractors should be trained on the proper material delivery and storage practices;
- Employees trained in emergency spill cleanup procedures must be present when dangerous materials or liquid chemicals are unloaded;

- If significant residual materials remain on the ground after construction is complete, properly remove materials and any contaminated soil. See WM-7, Contaminated Soil Management. If the area is to be paved, pave as soon as materials are removed to stabilize the soil; and
- Maintain a complete set of material safety data sheets at the project site.

Material Storage Areas and Practices

- Liquids, petroleum products, and substances listed in 40 CFR Parts 110, 117, or 302 should be stored in approved containers and drums and should not be overfilled. Containers and drums should be placed in temporary containment facilities for storage.
- A temporary containment facility should provide for a spill containment volume able to contain precipitation from a 25 year storm event, plus the greater of 10% of the aggregate volume of all containers or 100% of the capacity of the largest container within its boundary, whichever is greater.
- A temporary containment facility should be impervious to the materials stored therein for a minimum contact time of 72 hours.
- A temporary containment facility should be maintained free of accumulated rainwater and spills. In the event of spills or leaks, accumulated rainwater and spills should be collected and placed into drums. These liquids should be handled as a hazardous waste unless testing determines them to be non-hazardous. All collected liquids or non-hazardous liquids should be sent to an approved disposal site.
- Sufficient separation should be provided between stored containers to allow for spill cleanup and emergency response access.
- Incompatible materials, such as chlorine and ammonia, should not be stored in the same temporary containment facility.
- Throughout the rainy season, each temporary containment facility should be covered during non-working days, prior to, and during rain events.
- Materials should be stored in their original containers and the original product labels should be maintained in place in a legible condition. Damaged or otherwise illegible labels should be replaced immediately.
- Bagged and boxed materials should be stored on pallets and should not be allowed to accumulate on the ground. To provide protection from wind and rain throughout the rainy season, bagged and boxed materials should be covered during non-working days and prior to and during rain events.
- Stockpiles should be protected in accordance with WM-3, Stockpile Management.
- Materials should be stored indoors within existing structures or sheds when available.
- Proper storage instructions should be posted at all times in an open and conspicuous location.
- An ample supply of appropriate spill cleanup material should be kept near storage areas.
- Also see WM-6, Hazardous Waste Management, for storing of hazardous materials.

Material Delivery Practices

- Keep an accurate, up-to-date inventory of material delivered and stored onsite.
- Arrange for employees trained in emergency spill cleanup procedures to be present when dangerous materials or liquid chemicals are unloaded.

Spill Cleanup

- Contain and clean up any spill immediately.
- Properly remove and dispose of any hazardous materials or contaminated soil if significant residual materials remain on the ground after construction is complete. See WM-7, Contaminated Soil Management.
- See WM-4, Spill Prevention and Control, for spills of chemicals and/or hazardous materials.

Cost

The largest cost of implementation may be in the construction of a material's storage area that is covered and provides secondary containment.

Inspection and Maintenance

- Inspect and verify that activity-based BMPs are in place prior to the commencement of associated activities. While activities associated with the BMP are under way, inspect weekly during the rainy season and of two-week intervals in the non-rainy season to verify continued BMP implementation.
- Keep an ample supply of spill cleanup materials near the storage area.
- Keep storage areas clean, well organized, and equipped with ample cleanup supplies as appropriate for the materials being stored.
- Repair or replace perimeter controls, containment structures, covers, and liners as needed to maintain proper function.

References

Blueprint for a Clean Bay: Best Management Practices to Prevent Stormwater Pollution from Construction Related Activities; Santa Clara Valley Nonpoint Source Pollution Control Program, 1995.

California Stormwater Quality Association (CASQA) Best Management Practices Handbook Construction, 2003.

Coastal Nonpoint Pollution Control Program: Program Development and Approval Guidance, Working Group Working Paper; USEPA, April 1992.

Revised Ordinances of Honolulu Chapter 20 Fire Code of the City & County of Honolulu.

Stormwater Quality Handbooks - Construction Site Best Management Practices (BMPs) Manual, State of California Department of Transportation (Caltrans), November 2000.

Stormwater Management for Construction Activities; Developing Pollution Prevention Plans and Best Management Practice, EPA 832-R-92005; USEPA, April 1992.

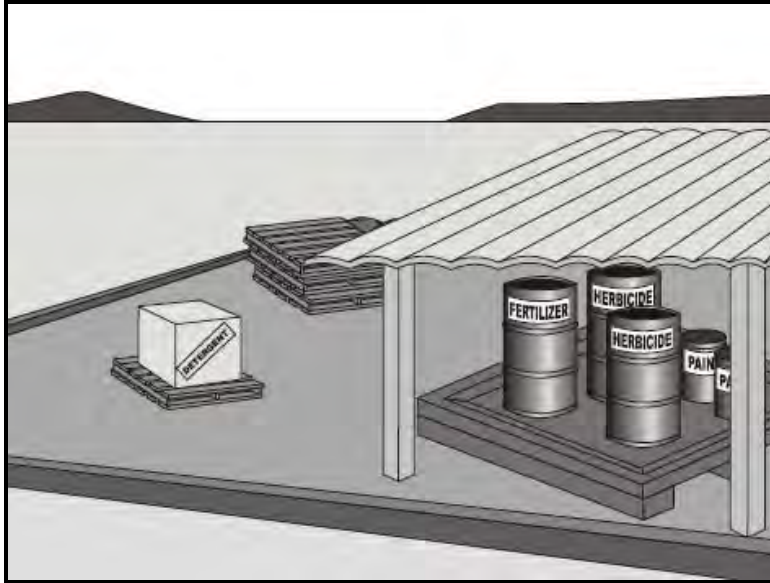

Description and Purpose

Prevent or reduce the discharge of pollutants to the storm drain system or watercourses from material use by using alternative products, minimizing hazardous material use onsite, and training employees and subcontractors.

Suitable Applications

This BMP is suitable for use at all construction projects. These procedures apply when the following materials are used or prepared onsite:

- Pesticides and herbicides;
- Fertilizers;
- Detergents;
- Plaster;
- Petroleum products such as fuel, oil, and grease;
- Asphalt and other concrete components;
- Other hazardous chemicals such as acids, lime, glues, adhesives, paints, solvents, and curing compounds;
- Concrete compounds; and/or
- Other materials that may be detrimental if released to the environment.

Limitations

Safer alternative building and construction products may not be available or suitable in every instance.

Objectives

- EC – Erosion Control
- SE – Sediment Control
- TR – Tracking Control
- WE – Wind Erosion Control
- NS – Non-Storm Water Management Control
- WM – Waste Management & Materials Pollution Control ✓

Legend:

- ✓ Primary Objective
- ▲ Secondary Objective

Targeted Constituents

- Sediment ✓
- Nutrients ✓
- Trash ✓
- Metals ✓
- Bacteria
- Oil and Grease ✓
- Organics ✓

Potential Alternatives

None

Implementation

The following steps should be taken to minimize risk:

- Minimize use of hazardous materials onsite;
- Follow manufacturer instructions regarding uses, protective equipment, ventilation, flammability, and mixing of chemicals;
- Train employees and subcontractors in proper material use;
- Supply Material Safety Data Sheets (MSDS) for all materials;
- Use recycled and less hazardous products when practical. Recycle residual paints, solvents, non-treated lumber, and other materials;
- Use materials only where and when needed to complete the construction activity. Use safer alternative materials as much as possible. Reduce or eliminate use of hazardous materials onsite when practical;
- Train personnel who use pesticides. The State Department of Agriculture (DOA), Pesticides Branch, licensed pesticide dealers, certifies pesticide applicators, and conducts on-site inspections;
- Do not over-apply fertilizers, herbicides, and pesticides. Prepare only the amount needed. Follow the recommended usage instructions. Over-application is expensive and environmentally harmful. Unless on steep slopes, till fertilizers into the soil rather than hydro seeding. Apply surface dressings in several smaller applications, as opposed to one large application, to allow time for infiltration and to avoid excess material being carried offsite by runoff. Do not apply these chemicals just before it rains;
- Do not remove the original product label; it contains important safety and disposal information. Use the entire product before disposing of the container;
- Use temporary scaffolding to hang drop cloths or draperies to prevent drift during painting work. Application equipment that minimizes overspray also helps. When using sealants on woods, pavement, roofs, etc., quickly clean up spills. Remove excess liquid with absorbent material or rags;
- If painting requires scraping or sand blasting of the existing surface, use a drop cloth to collect most of the chips. Dispose the residue properly. If the paint contains lead or tributyl tin, it is considered a hazardous waste. Refer to the waste management BMPs;
- Dispose of sand blasted material properly. Chips and dust from marine paints or paints containing lead should be disposed of as hazardous waste. Paint chips and dust from non-hazardous dry stripping and sand blasting may be swept up and disposed of as trash;
- Dispose of latex paint and paint cans, used brushes, rags, absorbent materials, and drop cloths, when thoroughly dry and are no longer hazardous, with other construction debris;
- Mix paint indoors or in a containment area. Never clean paintbrushes or rinse paint containers into a street, gutter, storm drain, or watercourse. Dispose of any paint thinners, residue, and sludge(s) that cannot be recycled, as hazardous waste;
- For water-based paint, clean brushes to the extent practicable, and rinse to a drain leading to a sanitary sewer where permitted, or into a concrete washout pit or temporary sediment trap. For oil-based paints, clean brushes to the extent practicable, and filter and reuse thinners and solvents;

- When working on roofs, if small particles have accumulated in the gutter, either sweep out the gutter or wash the gutter and trap the particles at the outlet of the downspout. A sock or geofabric placed over the outlet may effectively trap the materials. If the downspout is lined tight, place a temporary plug at the first convenient point in the storm drain and pump out the water with a vacuum (vactor) truck, and clean the catch basin sump and plug;
- Keep an ample supply of spill cleanup material near use areas. Train employees in spill cleanup procedures; and
- Avoid exposing applied materials to rainfall and runoff unless sufficient time has been allowed for them to dry.

Costs

All of the above are low cost measures.

Inspection and Maintenance

- Inspect and verify that activity-based BMPs are in place prior to the commencement of associated activities. While activities associated with the BMP are under way, inspect weekly during the rainy season and at two-week intervals in the non-rainy season to verify continued BMP implementation.
- Maintenance of this best management practice is minimal.
- Spot check employees and subcontractors throughout the job to ensure appropriate practices are being employed.

References

Blueprint for a Clean Bay: Best Management Practices to Prevent Stormwater Pollution from Construction Related Activities; Santa Clara Valley Nonpoint Source Pollution Control Program, 1995.

California Stormwater Quality Association (CASQA) Best Management Practices Handbook Construction, 2003.

Coastal Nonpoint Pollution Control Program: Program Development and Approval Guidance, Working Group Working Paper; USEPA, April 1992.

Hawaii Administrative Rules, Title 4, Chapter 66, Pesticides.

Hawaii Administrative Rules, Title 149, Hawaii Pesticides Law.

Stormwater Management for Construction Activities; Developing Pollution Prevention Plans and Best Management Practice, EPA 832-R-92005; USEPA, April 1992.

Stormwater Quality Handbooks - Construction Site Best Management Practices (BMPs) Manual, State of California Department of Transportation (Caltrans), November 2000.



Description and Purpose

Stockpiles can be a significant source of erosion and sediment, and measures should be taken to mitigate the potential for nonpoint source pollution. Information to be provided to the City and County of Honolulu, Department of Planning and Permitting, when applying for a stockpiling permit include “a plot plan showing the property lines, easements and setbacks, topography, and the location of the proposed stockpile, quantities, height of stockpile, life of stockpile and source of the material to be stockpiled,” and other information as may be required to “control the emission of air-borne dust, drainage runoff or erosion problems.”

Stockpile Management procedures and practices are designed to reduce or eliminate air and storm water pollution from stockpiles of soil, paving materials such as portland cement concrete (PCC) rubble, asphalt concrete (AC), asphalt concrete rubble, aggregate base, aggregate sub base or pre-mixed aggregate, temporary asphalt (so called “cold mix” asphalt), and pressure treated wood.

Suitable Applications

- Stockpiles for gravel or topsoil in roadway areas.
- Stockpiles for excavated material to be moved to off-site locations.
- Stockpiles of imported material.
- Stockpiles for surcharging to stabilize or consolidate an area.

Objectives

- EC – Erosion Control
- SE – Sediment Control
- TR – Tracking Control
- WE – Wind Erosion Control
- NS – Non-Storm Water Management Control
- WM – Waste Management & Materials Pollution Control ✓

Legend:

- ✓ Primary Objective
- ▲ Secondary Objective

Targeted Constituents

- Sediment ✓
- Nutrients ✓
- Trash ✓
- Metals ✓
- Bacteria
- Oil and Grease ✓
- Organics ✓

Potential Alternatives

None

Limitations

Stockpiles are for temporary storage of materials. Provisions should be made for permanent movement of stockpiled material. Failure to contain stockpiled material may cause downstream erosion or flood damage. Stockpiles not properly stabilized may cause fugitive dust problems.

Keep maximum height of stockpiles no greater than 15 feet high. Anything greater than 15 feet requires 8-foot wide benching (ROH Article 15).

Implementation

- Provide adequate setback from waterways.
- Provide earth dikes or other diversion to keep runoff away from stockpiles.
- Provide silt fences at the toe of the stockpile to mitigate runoff during rain events.
- Cover, grass or provide other stabilization measures.
- Provide adequate setback distance from lot lines.
- Provide silt basins where required.

Protection of stockpiles is a year-round requirement. To properly manage stockpiles:

- Locate stockpiles a minimum of 50 ft. away from concentrated flows of storm water, drainage courses, and inlets.
- Protect all stockpiles from storm water runoff using a temporary perimeter sediment barrier such as berms, dikes, fiber rolls, silt fences, sandbag, gravel bags, or straw bale barriers.
- Implement wind erosion control practices as appropriate on all stockpiled material. For specific information, see WE-1, Wind Erosion Control.
- Manage stockpiles of contaminated soil in accordance with WM-7, Contaminated Soil Management.
- Place bagged materials on pallets and under cover.

Protection of Non-Active Stockpiles

Non-active stockpiles of the identified materials should be protected further as follows:

Soil stockpiles

- During the rainy season, soil stockpiles should be covered or protected with soil stabilization measures and a temporary perimeter sediment barrier at all times.
- During the non-rainy season, soil stockpiles should be covered or protected with a temporary perimeter sediment barrier prior to the onset of precipitation.

Stockpiles of Portland cement concrete rubble, asphalt concrete, asphalt concrete rubble, aggregate base, or aggregate sub base

- During the rainy season, the stockpiles should be covered or protected with a temporary perimeter sediment barrier at all times.
- During the non-rainy season, the stockpiles should be covered or protected with a temporary perimeter sediment barrier prior to the onset of precipitation.

Stockpiles of “cold mix”

- During the rainy season, cold mix stockpiles should be placed on and covered with plastic or comparable material at all times.
- During the non-rainy season, cold mix stockpiles should be placed on and covered with plastic or comparable material prior to the onset of precipitation.

Stockpiles/Storage of pressure treated wood with chromate copper arsenate or ammoniacal copper zinc arsenate

- During the rainy season, treated wood should be covered with plastic or comparable material at all times.
- During the non-rainy season, treated wood should be covered with plastic or comparable material at all times and cold mix stockpiles should be placed on and covered with plastic or comparable material prior to the onset of precipitation.

Protection of Active Stockpiles

Active stockpiles of the identified materials should be protected further as follows:

- All stockpiles should be protected with a temporary linear sediment barrier prior to the onset of precipitation.
- Stockpiles of “cold mix” should be placed on and covered with plastic or comparable material prior to the onset of precipitation.

Costs

All of the above are low cost measures.

Inspection and Maintenance

- Inspect and verify that activity-based BMPs are in place prior to the commencement of associated activities. While activities associated with the BMP are under way, inspect weekly during the rainy season and of two-week intervals in the non-rainy season to verify continued BMP implementation.
- Repair and/or replace perimeter controls and covers as needed to keep them functioning properly.

References

California Stormwater Quality Association (CASQA) Best Management Practices Handbook Construction, 2003.

Revised Ordinances of Honolulu Chapter 14, Article 14 Permits, Bonds and Inspection for Grading, Soil Erosion and Sediment Control, 1990 as amended.

Revised Ordinances of Honolulu Article 15 Grading, Grubbing and Stockpiling. Stormwater Quality Handbooks Construction Site Best Management Practices (BMPs) Manual, State of California Department of Transportation (Caltrans), November 2000.

Stormwater Quality Handbooks - Construction Site Best Management Practices (BMPs) Manual, State of California Department of Transportation (Caltrans), November 2000.

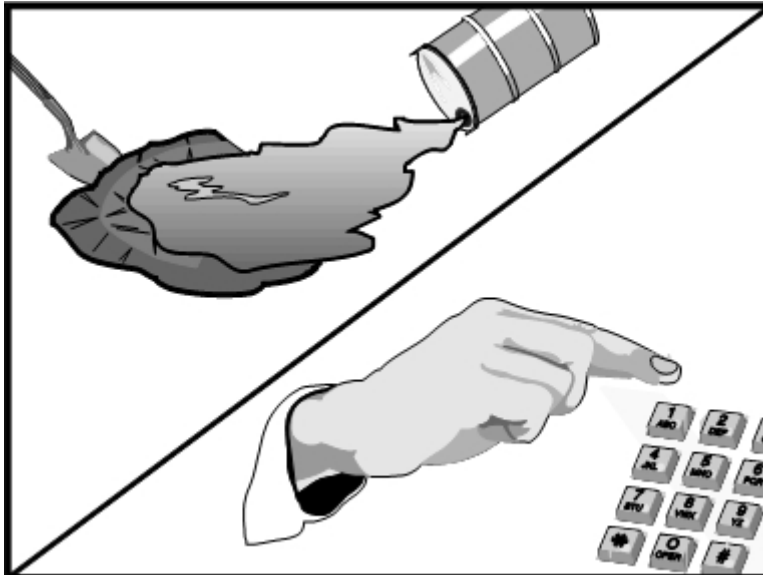

Description and Purpose

Prevent or reduce the discharge of pollutants to drainage systems or watercourses from leaks and spills by reducing the chance for spills, stopping the source of spills, containing and cleaning up spills, properly disposing of spill materials, and training employees.

This best management practice covers only spill prevention and control. However, WM-1 Materials Delivery and Storage, and WM-2 Material Use, also contain useful information, particularly on spill prevention. For information on wastes, see the waste management BMPs in this section.

Suitable Applications

This BMP is suitable for all construction projects. Spill control procedures are implemented anytime chemicals or hazardous substances are stored on the construction site, including the following materials:

- Soil stabilizers/binders,
- Dust palliatives,
- Herbicides,
- Growth inhibitors,
- Fertilizers,
- Deicing/anti-icing chemicals,
- Fuels,
- Lubricants, and/or
- Other petroleum distillates.

Objectives

- EC – Erosion Control
- SE – Sediment Control
- TR – Tracking Control
- WE – Wind Erosion Control
- NS – Non-Storm Water Management Control
- WM – Waste Management & Materials Pollution Control ✓

Legend:

- ✓ Primary Objective
- ▲ Secondary Objective

Targeted Constituents

- Sediment ✓
- Nutrients ✓
- Trash ✓
- Metals ✓
- Bacteria
- Oil and Grease ✓
- Organics ✓

Potential Alternatives

None

Limitations

- In some cases it may be necessary to use a private spill cleanup company.
- This BMP applies to spills caused by the contractor and subcontractors.
- Procedures and practices presented in this BMP are general. Contractor should identify appropriate practices for the specific materials used or stored onsite.

Implementation

The following steps will help reduce the storm water impacts of leaks and spills:

Education

- Be aware that different materials pollute in different amounts. Make sure that each employee knows what a “significant spill” is for each material they use, and what is the appropriate response for “significant” and “insignificant” spills.
- Educate employees and subcontractors on potential dangers to humans and the environment from spills and leaks.
- Hold regular meetings to discuss and reinforce appropriate disposal procedures (incorporate into regular safety meetings).
- Establish a continuing education program to indoctrinate new employees.
- Have contractor’s superintendent or representative oversee and enforce proper spill prevention and control measures.

General Measures

- Provide a spill prevention control and countermeasure (SPCC) plan when the above ground storage volume is equal to or greater than 1320 gallons (40 CFR 112.1 (d)(2)(ii)).
- To the extent that the work can be accomplished safely, spills of oil, petroleum products, substances listed under 40 CFR parts 110,117, and 302, and sanitary and septic wastes should be contained and cleaned up immediately.
- Store hazardous materials and wastes in covered containers and protect from vandalism.
- Place a stockpile of spill cleanup materials where it will be readily accessible.
- Train employees in spill prevention and cleanup.
- Designate responsible individuals to oversee and enforce control measures.
- Prepare and maintain a spill response plan at the project site.
- Spills should be covered and protected from storm water runoff during rainfall to the extent that it doesn’t compromise cleanup activities.
- Do not bury or wash spills with water.
- Store and dispose of used clean up materials, contaminated materials, and recovered spill material that is no longer suitable for the intended purpose in conformance with the provisions in applicable BMPs.
- Do not allow water used for cleaning and decontamination to enter storm drains or watercourses. Collect and dispose of contaminated water in accordance with WM-10 Liquid Waste Management.
- Contain water overflow or minor water spillage and do not allow it to discharge into drainage facilities or watercourses.

- Place proper storage, cleanup, and spill reporting instructions for hazardous materials stored or used on the project site in an open, conspicuous, and accessible location.
- Keep waste storage areas clean, well organized, and equipped with ample cleanup supplies as appropriate for the materials being stored. Perimeter controls, containment structures, covers, and liners should be repaired or replaced as needed to maintain proper function.

Cleanup

- Clean up leaks and spills immediately.
- Use a rag for small spills on paved surfaces, a damp mop for general cleanup, and absorbent material for larger spills. If the spilled material is hazardous, then the used cleanup materials are also hazardous and must be sent to either a certified laundry (rags) or disposed of as hazardous waste.
- Never hose down or bury dry material spills. Clean up as much of the material as possible and dispose of properly. See the waste management BMPs in this section for specific information.

Minor Spills

- Minor spills typically involve small quantities of oil, gasoline, paint, etc. which can be controlled by the first responder at the discovery of the spill.
- Use absorbent materials on small spills rather than hosing down or burying the spill.
- Absorbent materials should be promptly removed and disposed of properly.
- Follow the practice below for a minor spill:
 - Contain the spread of the spill,
 - Recover spilled materials, and
 - Clean the contaminated area and properly dispose of contaminated materials.

Semi-Significant Spills

- Semi-significant spills still can be controlled by the first responder along with the aid of other personnel such as laborers and the foreman, etc. This response may require the cessation of all other activities.
- Spills should be cleaned up immediately:
 - Contain spread of the spill;
 - Notify the project foreman immediately;
 - If the spill occurs on paved or impermeable surfaces, clean up using "dry" methods (absorbent materials, cat litter and/or rags). Contain the spill by encircling with absorbent materials and do not let the spill spread widely;
 - If the spill occurs in dirt areas, immediately contain the spill by constructing an earthen dike. Dig up and properly dispose of contaminated soil; and
 - If the spill occurs during rain, cover spill with tarps or other material to prevent contaminating runoff.

Significant/Hazardous Spills

- For significant or hazardous spills that cannot be controlled by personnel in the immediate vicinity, the following steps should be taken:
 - Notify the local emergency response by dialing 911. In addition to 911, the contractor will notify the proper City and County officials. It is the contractor's responsibility to have all emergency phone numbers at the construction site;
 - For spills of federal reportable quantities, in conformance with the requirements in 40 CFR parts 110,119, and 302, the contractor should notify the National Response Center at (800) 424-8802;
 - Notification should first be made by telephone and followed up with a written report;
 - The services of a spills contractor or a HazMat team should be obtained immediately. Construction personnel should not attempt to clean up until the appropriate and qualified staffs have arrived at the job site; and
 - Other agencies which may need to be consulted include, but are not limited to Hawaii State Department of Health Hazard Evaluation and Emergency Response Office, Honolulu Local Emergency Planning Committee, Honolulu Fire Department, the Coast Guard, Hawaii National Guard, the Department of Transportation, the City and County Police Department, Department of Health Solid Waste & Hazardous Waste Branch, Department of Health Clean Water Branch, Department of Labor & Industrial Relations Hawaii Occupational Safety and Health Administration (HIOSHA), etc.

Reporting

- Report significant spills to local agencies, such as the Fire Department; they can assist in cleanup.
- Federal regulations require that any significant oil spill into a water body or onto an adjoining shoreline be reported to the National Response Center (NRC) at 800-424-8802 (24 hours).

Use the following measures related to specific activities:

Vehicle and Equipment Maintenance

- If maintenance must occur onsite, use a designated area and a secondary containment, located away from drainage courses, to prevent the runoff of storm water and the runoff of spills.
- Regularly inspect onsite vehicles and equipment for leaks and repair immediately.
- Check incoming vehicles and equipment (including delivery trucks, and employee and subcontractor vehicles) for leaking oil and fluids. Do not allow leaking vehicles or equipment onsite.
- Always use secondary containment, such as a drain pan or drop cloth, to catch spills or leaks when removing or changing fluids.
- Place drip pans or absorbent materials under paving equipment when not in use.
- Use absorbent materials on small spills rather than hosing down or burying the spill. Remove the absorbent materials promptly and dispose of properly.

- Promptly transfer used fluids to the proper waste or recycling drums. Don't leave full drip pans or other open containers lying around.
- Oil filters disposed of in trashcans or dumpsters can leak oil and pollute storm water. Place the oil filter in a funnel over a waste oil-recycling drum to drain excess oil before disposal. Oil filters can also be recycled. Ask the oil supplier or recycler about recycling oil filters.
- Store cracked batteries in a non-leaking secondary container. Do this with all cracked batteries even if you think all the acid has drained out. If you drop a battery, treat it as if it is cracked. Put it into the containment area until you are sure it is not leaking.

Vehicle and Equipment Fueling

- If fueling must occur onsite, use designate areas, located away from drainage courses, to prevent the runoff of storm water and the runoff of spills.
- Discourage "topping off" of fuel tanks.
- Always use secondary containment, such as a drain pan, when fueling to catch spills/leaks.

Costs

Prevention of leaks and spills is inexpensive. Treatment and/or disposal of contaminated soil or water can be quite expensive.

Inspection and Maintenance

- Inspect and verify that activity-based BMPs are in place prior to the commencement of associated activities. While activities associated with the BMP are under way, inspect weekly during the rainy season and of two-week intervals in the non-rainy season to verify continued BMP implementation.
- Inspect BMPs subject to non-storm water discharge daily while non-storm water discharges occur.
- Keep ample supplies of spill control and cleanup materials onsite, near storage, unloading, and maintenance areas.
- Update your spill prevention and control plan and stock cleanup materials as changes occur in the types of chemicals onsite.

References

Blueprint for a Clean Bay: Best Management Practices to Prevent Stormwater Pollution from Construction Related Activities; Santa Clara Valley Nonpoint Source Pollution Control Program, 1995.

California Stormwater Quality Association (CASQA) Best Management Practices Handbook Construction, 2003.

Hawaii Administrative Rules 11-262 Hazardous Waste Management Standards Applicable to Generators of Hazardous Waste.

Stormwater Management for Construction Activities; Developing Pollution Prevention Plans and Best Management Practice, EPA 832-R-92005; USEPA, April 1992.

Stormwater Quality Handbooks - Construction Site Best Management Practices (BMPs) Manual, State of California Department of Transportation (Caltrans), November 2000.

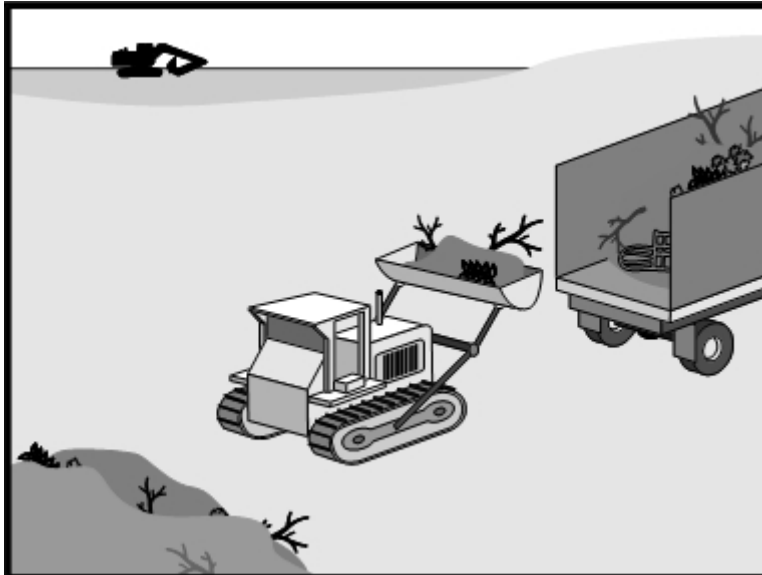

Description and Purpose

Prevent or reduce discharge of pollutants to the land, groundwater, in storm water from solid waste or construction and demolition (C&D) waste by providing designated waste collection areas, separate containers for recyclable waste materials, timing collection of waste and recyclable materials with each stage of the construction or demolition project, and properly training subcontractors and employees.

Table 4-3 Quick Reference – Disposal Alternatives include guidance on solid waste reuse, recycling, and disposal by select activities.

Suitable Applications

Solid waste is one of the major pollutants resulting from both construction and demolition activities that also contribute to illegal dumping.

Construction and demolition (C&D) waste is defined as solid, largely inert waste, resulting from the demolition or razing of buildings, of roads, or other structures, such as concrete, brick, bituminous concrete, wood, and masonry, composition roofing, and roofing paper, steel, plaster, and minor amount of other metals such as copper. Cleanup materials contaminated with hazardous substances, friable asbestos, waste paint, solvents, sealers, adhesives, or similar materials are not acceptable at C&D disposal sites.

One “subset” of C&D waste deserves special mention, because large volumes of these wastes are generated on construction

Objectives

- EC – Erosion Control
- SE – Sediment Control
- TR – Tracking Control
- WE – Wind Erosion Control
- NS – Non-Storm Water Management Control
- WM – Waste Management & Materials Pollution Control ✓

Legend:

- ✓ Primary Objective
- ▲ Secondary Objective

Targeted Constituents

- Sediment ✓
- Nutrients ✓
- Trash ✓
- Metals ✓
- Bacteria
- Oil and Grease ✓
- Organics ✓

Potential Alternatives

None

demolition sites. Inert fill materials should not be commingled with other C&D waste, especially if intended for reuse.

Inert fill material is defined as earth, soil, rock, rock-like material such as cured asphalt, brick, and clean concrete (with no exposed steel-reinforcing rod) less than eight inches in its greatest dimension, except as specified by a registered soils engineer. The fill material shall not contain vegetation or organic material, or other solid waste.

Inert fill materials are wastes that essentially will not decompose or produce leachate or other releases of environmental concern, nor be contaminated with items of concern like asbestos, and lead-based paint (LBP). Place qualifying as inert fill material according to both City and County and State DOH regulations have reuse potential. County and State laws prohibit other types and volumes of solid waste from job-sites from being used as fill material; instead, we must transport for disposal to a DOH-permitted landfill.

Recycling, Reuse Encouraged Over Disposal

Some C&D waste generated on-site should be recycled or reused whenever and wherever possible. These wastes include but are not limited to:

- Recycling:
 - Asphalt pavement,
 - Cardboard,
 - Concrete aggregate (no LBP, asbestos-free),
 - Electronic equipment – wiring, fluorescent light ballasts and tubes,
 - Excavated rock,
 - Excavated soil (uncontaminated),
 - Freon from appliances – air conditioners and refrigerators,
 - Glass,
 - Green waste – yard and tree trimmings, trunks, limbs,
 - Metals, ferrous – steel from appliances, concrete rebar,
 - Metals, non-ferrous – aluminum brass, copper, stainless-steel,
 - Used tires, and/or
 - Wood and lumber (untreated, no LBP, asbestos-free) – esp. pallets.
- Reuse:
 - Reusable building materials for self-help housing projects,
 - Small appliances and other used household items (e.g., fixtures), and/or
 - Used furniture.

The State DOH, Office of Solid Waste Management has developed a guide, “Minimizing Construction and Demolition Waste,” especially for contractors, architects, builders, and design professionals. The DOH guide features:

- A checklist on how to start managing C&D waste,
- A list of available and DOH-permitted recycling and disposal facilities which can handle or process recyclable and reusable materials, and

- A brief regulatory overview of C&D waste and how important it is to recycle.

Free copies of the DOH guide can be obtained by calling 586-4226.

In addition, the State Department of Business and Economic Development & Tourism (DBEDT), Clean Hawaii Center has a specialized waste management guide for contractors supervising construction and demolition activities. “A Contractor’s Waste Management Guide: Best management Practices and Tools for Job Site Recycling and Waste Reduction in Hawaii” features a Solid Waste Management Checklist offering practical tips on:

- How to build with used building materials,
- What recycled-content materials to consider in the design phase,
- Deciding where best to use recycled-content materials (e.g., use cold-formed steel framing with a minimum of 25 percent recycle content, and assemble with good quality connectors to prevent corrosion),
- Choosing the most helpful suppliers,
- Training subcontractors to reduce waste,
- What job-site operations most effectively reduced job-site waste volumes,
- Specific, environmentally-friendly ways on controlling termites, and
- How to reduce framing waste using advanced-framing techniques.

The DBEDT manual also offers detailed, helpful tips on managing hazardous wastes (see page 1–17) and a “General Practices Checklist” for training subcontractors and employees how to maximize opportunities for on-site waste reduction recycling. For a free copy of the guide, contact DBEDT at 587-3802.

The DBEDT emphasizes recycling and waste reduction as environmentally-responsible job-site waste management practices. And depending upon the type and scale of your project, implementing sound solid waste reduction practices may reduce your overall disposal costs. Other best management practices related to solid waste include: on-site separation of recyclable C&D materials from wastes intended for disposal; minimizing drive-by contamination of recycling bins, and shielding them from the weather; ensuring all refuse is promptly removed; ascertaining waste types generated at various stages of the project, and scheduling timed, specialized pickups for those recyclable materials. These solid waste management practices will mitigate health and safety hazards, enhance the appearance of the construction area, and help reduce waste management costs.

Limitations

Temporary stockpiling of certain construction wastes may not necessitate stringent drainage related controls during the non-rainy season or in desert areas with low rainfall.

Implementation

The following steps will help keep a clean site and reduce pollution to storm water, to the land and protect groundwater resources:

- Select designated waste collection areas onsite;
- Inform trash-hauling contractors that you will accept only watertight dumpsters for onsite use. Inspect dumpsters for leaks and repair any dumpster that is not watertight;

- Locate containers in a covered area or in a secondary containment;
- Provide an adequate number of containers with lids or covers that can be placed over the container to keep rain out or to prevent loss of wastes when it is windy;
- Plan for additional containers and more frequent pickup during the demolition phase of construction;
- Collect site trash daily, especially during rainy and windy conditions;
- Remove this solid waste promptly since erosion and sediment control devices tend to collect litter;
- Make sure that toxic liquid wastes (used oils, solvents, and paints) and chemicals (acids, pesticides, additives, curing compounds) are not disposed of in dumpsters designated for construction debris;
- Do not hose out dumpsters on the construction site. Leave dumpster cleaning to the trash hauling contractor;
- Arrange for regular waste collection before containers overflow;
- Clean up immediately if a container does spill; and
- Make sure that construction waste is collected, removed, and disposed of only at authorized disposal areas.

Education

- Have the contractor's superintendent or representative oversee and enforce proper solid waste management procedures and practices.
- Instruct employees and subcontractors on identification of solid waste and hazardous waste.
- Educate employees and subcontractors on solid waste storage and disposal procedures.
- Hold regular meetings to discuss and reinforce disposal procedures (incorporate into regular safety meetings).
- Require that employees and subcontractors follow solid waste handling and storage procedures.
- Prohibit littering by employees, subcontractors, and visitors.
- Minimize production of solid waste materials wherever possible.

Collection, Storage, and Disposal

- Littering on the project site should be prohibited.
- To prevent clogging of the storm drainage system, litter and debris removal from drainage grates, trash racks, and ditch lines should be a priority.
- Trash receptacles should be provided in the contractor's yard, field trailer areas, and at locations where workers congregate for lunch and break periods.
- Litter from work areas within the construction limits of the project site should be collected and placed in watertight dumpsters at least weekly, regardless of whether the litter was generated by the contractor, the public, or others. Collected litter and debris should not be placed in or next to drain inlets, storm water drainage systems, or watercourses.

- Dumpsters of sufficient size and number should be provided to contain the solid waste generated by the project.
- Full dumpsters should be removed from the project site and the contents should be disposed of by the trash hauling contractor.
- Construction debris and waste should be removed from the site biweekly or more frequently as needed.
- Construction material visible to the public should be stored or stacked in an orderly manner.
- Storm water runoff should be prevented from contacting stored solid waste through the use of berms, dikes, or other temporary diversion structures or through the use of measures to elevate waste from site surfaces.
- Solid waste storage areas should be located at least 50 ft. from drainage facilities and watercourses and should not be located in areas prone to flooding or ponding.
- Except during fair weather, construction and highway planting waste not stored in watertight dumpsters should be securely covered from wind and rain by covering the waste with tarps or plastic.
- Segregate potentially hazardous waste from non-hazardous construction site waste.
- Make sure that toxic liquid wastes (used oils, solvents, and paints) and chemicals (acids, pesticides, additives, curing compounds) are not disposed of in dumpsters designated for construction debris.
- For disposal of hazardous waste, see WM-6, Hazardous Waste Management. Have hazardous waste hauled to an appropriate disposal and/or recycling facility.
- Salvage or recycle useful vegetation debris, packaging and surplus building materials when practical. For example, trees and shrubs from land clearing can be used as a brush barrier, or converted into wood chips, then used as mulch on graded areas. Wood pallets, cardboard boxes, and construction scraps can also be recycled.

Costs

All of the above are low cost measures.

Inspection and Maintenance

- Inspect and verify that activity-based BMPs are in place prior to the commencement of associated activities. While activities associated with the BMP are under way, inspect weekly during the rainy season and of two-week intervals in the non-rainy season to verify continued BMP implementation.
- Inspect BMPs subject to non-storm water discharge daily while non-storm water discharges occur.
- Inspect construction waste area regularly.
- Arrange for regular waste collection.
- Inspect construction waste and recycling areas regularly for signs of contamination.
- State collection of recycled materials according to each phase of the construction/demolition project.
- Also, refer to DBEDT's BMP guide outlined in this section.

References

A Contractor's Waste Management Guide: Best Management Practices and Tools for Job Site Recycling and Waste Reduction in Hawaii, DBEDT, January 1999.

Best Management Practices and Erosion Control Manual for Construction Sites; Flood Control District of Maricopa County, AZ, September 1992.

California Stormwater Quality Association (CASQA) Best Management Practices Handbook Construction, 2003.

Minimizing Construction and Demolition Waste: A C&D Waste Management Guide, First Edition, DOH, February 1998.

Processes, Procedures and Methods to Control Pollution Resulting from All Construction Activity, 430/9-73-007, USEPA, 1973.

Residential Construction Waste Management: A Builder's Field Guide (How to Save Money and Landfill Space), NAHB Research Center, 1997.

State of Hawaii Department of Business and Economic Development & Tourism
<http://www.hawaii.gov/dbedt>.

State of Hawaii Department of Health Office of Solid Waste Management Branch
<http://www.hawaii.gov/health/about/environmental/waste/SW/index.html>.

Storm Water Management for Construction Activities; Developing Pollution Prevention Plans and Best Management Practice, EPA 832-R-92005; USEPA, April 1992.

Stormwater Quality Handbooks - Construction Site Best Management Practices (BMPs) Manual, State of California Department of Transportation (Caltrans), November 2000.

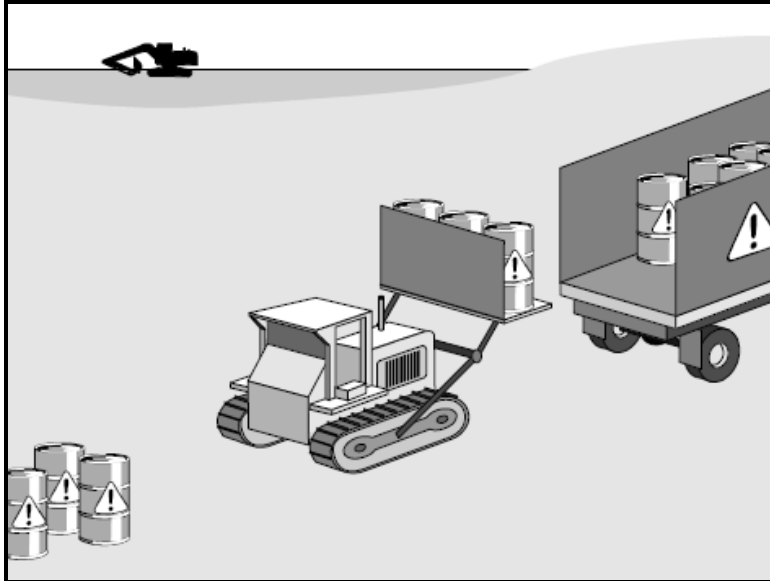

Description and Purpose

Prevent or reduce the discharge of pollutants to storm water from hazardous waste through proper material use, waste disposal, and training of employees and subcontractors.

Suitable Applications

This best management practice (BMP) applies to all construction projects. Hazardous waste management practices are implemented on construction projects that generate waste from the use of:

- Petroleum Products,
- Concrete Curing Compounds,
- Palliatives,
- Septic Wastes,
- Stains,
- Wood Preservatives,
- Asphalt Products,
- Pesticides,
- Acids,
- Paints,
- Solvents,
- Roofing Tar, and/or
- C&D Wastes, including clean-up materials, contaminated with hazardous substances (for more information on C&D wastes, see WM-5 Solid Waste Management).

Objectives

- EC – Erosion Control
- SE – Sediment Control
- TR – Tracking Control
- WE – Wind Erosion Control
- NS – Non-Storm Water Management Control
- WM – Waste Management & Materials Pollution Control ✓

Legend:

- ✓ Primary Objective
- ▲ Secondary Objective

Targeted Constituents

- Sediment
- Nutrients ✓
- Trash ✓
- Metals ✓
- Bacteria ✓
- Oil and Grease ✓
- Organics ✓

Potential Alternatives

None

In addition, sites with existing structures may contain wastes, which must be disposed of in accordance with Federal and State regulations. These wastes include:

- Sandblasting grit or chips contaminated with lead-, cadmium-, or chromium-based paints, as regulated under the State of Hawaii Department of Health Noise Radiation and Indoor Air Quality Branch (NRFAQ) and Federal Clean Air Act;
- Asbestos as regulated under the State of Hawaii Department of Health Noise Radiation and Indoor Air Quality Branch (NRFAQ) and Federal Clean Air Act; and
- PCBs (particularly in older transformers) as regulated under the Federal Toxic Substances Control Act (TSCA).

To determine if a material or item is potentially hazardous waste:

- Check label and shipping papers;
- Look for words such as hazardous, danger, caustic or corrosive (dissolves skin, metal or other materials); flammable or ignitable (catches fire easily); carcinogenic (causes cancer); and toxic or poisonous (harms people and animals). A list of hazardous waste and criteria are found in Hawaii Administrative Rules (HAR) Title 11, Chapter 261 Hazardous Waste Management Identification and Listing of Hazardous Waste;
- Check the material safety data sheet (MSDS) the manufacturer must prepare for the product. Ask your supplier for a copy; and/or
- For questions and additional information including fact sheets and flyers, call the DOH, Hazardous Waste Program Office at 586-4226.

Limitations

- Hazardous waste that cannot be reused or recycled must be disposed of by a professional hazardous waste hauler.
- Nothing in this BMP relieves the contractor from responsibility for compliance with federal and state laws regarding storage, handling, transportation, and disposal of hazardous wastes.
- This BMP does not cover aeriaily deposited lead (ADL) soils. For ADL soils refer to WM-7, Contaminated Soil Management.

Implementation

The following steps will help reduce storm water and land pollution concerns resulting from hazardous wastes:

Material Use

- Wastes should be stored in sealed containers constructed of a suitable material.
- All hazardous waste should be stored, transported, and disposed as required.
- Waste containers should be stored in temporary containment facilities that should comply with the following requirements:
 - Temporary containment facility should provide for a spill containment volume equal to 1.5 times the volume of all containers able to contain precipitation from a 25 year storm event, plus the greater of 10% of the aggregate volume of all containers or 100% of the capacity of the largest tank within its boundary, whichever is greater;

- Temporary containment facility should be impervious to the materials stored there for a minimum contact time of 72 hours;
 - Temporary containment facilities should be maintained free of accumulated rain water and spills. In the event of spills or leaks, accumulated rain water and spills should be placed into drums after each rainfall. These liquids should be handled as a hazardous waste unless testing determines them to be non-hazardous. Non-hazardous liquids should be sent to an approved disposal site;
 - Sufficient separation should be provided between stored containers to allow for spill cleanup and emergency response access;
 - Incompatible materials, such as chlorine and ammonia, should not be stored in the same temporary containment facility; and
 - Throughout the rainy season, temporary containment facilities should be covered during non-working days, and prior to rain events. Covered facilities may include use of plastic tarps for small facilities or constructed roofs with overhangs.
- Drums should not be overfilled and wastes should not be mixed.
 - Unless watertight, containers of dry waste should be stored on pallets.
 - Do not over-apply herbicides and pesticides. Prepare only the amount needed. Follow the recommended usage instructions. Over application is expensive and environmentally harmful. Apply surface dressings in several smaller applications, as opposed to one large application. Allow time for infiltration and avoid excess material being carried offsite by runoff. Do not apply these chemicals just before it rains. People applying restricted-use pesticides must be certified in accordance with federal and state (HAR 4-6-66 Pesticide, section 4-66-32 restricted use pesticides) regulations.
 - Paint brushes and equipment for water and oil based paints should be cleaned within a contained area and should not be allowed to contaminate site soils, watercourses, or drainage systems. Waste paints, thinners, solvents, residues, and sludges that cannot be recycled or reused should be disposed of as hazardous waste. When thoroughly dry, latex paint and paint cans, used brushes, rags, absorbent materials, and drop cloths should be disposed of as solid waste.
 - Do not clean out brushes or rinse paint containers into the dirt, street, gutter, storm drain, or stream. “Paint out” brushes as much as possible. Rinse water-based paints to the sanitary sewer. Filter and reuse thinners and solvents. Dispose of excess oil-based paints and sludge as hazardous waste.
 - Consult the “Hazardous Waste management Checklist” within the State Department of Business and Economic Development and Tourism (DBEDT’s) “A Contractor’s Waste Management Guide: Best Management Practices and Tools for Job Site Recycling and Waste Reduction in Hawaii” for additional tips and BMPs on selecting and purchasing lesser-toxic building products.

The DBEDT manual also offers detailed, helpful tips on solid waste management (see WM-5) and a “General Practices Checklist” for training subcontractors and employees how to maximize opportunities for on-site waste reduction and recycling. For a free copy of the guide, contact DBEDT at 587-3802.

- The following actions should be taken with respect to temporary contaminant:
 - Ensure that adequate hazardous waste storage volume is available;
 - Ensure that hazardous waste collection containers are conveniently located;
 - Designate hazardous waste storage areas onsite away from storm drains or watercourses and away from moving vehicles and equipment to prevent accidental spills;
 - Minimize production or generation of hazardous materials and hazardous waste on the job site;
 - Use containment berms in fueling and maintenance areas and where the potential for spills is high;
 - Segregate potentially hazardous waste from non-hazardous construction site debris;
 - Keep liquid or semi-liquid hazardous waste in appropriate containers (closed drums or similar) and under cover;
 - Clearly label all hazardous waste containers with the waste being stored and the date of accumulation;
 - Place hazardous waste containers in secondary containment;
 - Do not allow potentially hazardous waste materials to accumulate on the ground;
 - Do not mix wastes;
 - Use all of the product before disposing of the container; and
 - Do not remove the original product label; it contains important safety and disposal information.

Waste Recycling Disposal

- Select designated hazardous waste collection areas onsite.
- Hazardous materials and wastes should be stored in covered containers and protected from vandalism.
- Place hazardous waste containers in secondary containment.
- Do not mix wastes, this can cause chemical reactions, making recycling impossible and complicating disposal.
- Recycle any useful materials such as used oil or water-based paint.
- Make sure that toxic liquid wastes (used oils, solvents, and paints) and chemicals (acids, pesticides, additives, curing compounds) are not disposed of in dumpsters designated for construction debris.
- Arrange for regular waste collection before containers overflow.
- Make sure that hazardous waste (e.g., excess oil-based paint and sludge) is collected, removed, and disposed of only at authorized disposal areas.
- Consult the “Hazardous Waste Management Checklist” within the State DBEDT’s “A Contractor’s Waste Management Guide: Best Management Practices and Tools for Job Site Recycling and Waste Reduction in Hawaii” for additional tips and BMPs on how to reduce hazardous waste volumes, and how to best determine if a material or item is a potentially hazardous waste.

Disposal Procedures

- Waste should be disposed of by a professional hazardous waste transporter at an authorized and licensed disposal facility or recycling facility utilizing properly completed Uniform Hazardous Waste Manifest forms.
- A laboratory following EPA methods and standards should sample waste to determine the appropriate disposal facility.
- Properly dispose of rainwater in secondary containment that may have mixed with hazardous waste.

Education

- Train employees and subcontractors in proper hazardous waste management. Consult the “Hazardous Waste management Checklist” within the State DBEDT’s “A Contractor’s Waste Management Practices and Tools for Job Site Recycling and Waste Reduction in Hawaii” for tips and other useful resources available to help you train your employees and subcontractors.
- Educate employees and subcontractors on hazardous waste storage and disposal procedures.
- Educate employees and subcontractors on potential dangers to humans and the environment from hazardous wastes.
- Instruct employees and subcontractors on safety procedures for common construction site hazardous wastes.
- Instruct employees and subcontractors in identification of hazardous and solid waste.
- Hold regular meetings to discuss and reinforce hazardous waste management procedures (incorporate into regular safety meetings).
- The contractor’s superintendent or representative should oversee and enforce proper hazardous waste management procedures and practices.
- Make sure that hazardous waste is collected, removed, and disposed of only at authorized disposal areas.
- Warning signs should be placed in areas recently treated with chemicals.
- Place a stockpile of spill cleanup materials where it will be readily accessible.
- If a container does spill, clean up immediately.

Costs

All of the above are low cost measures.

Inspection and Maintenance

- Inspect and verify that activity-based BMPs are in place prior to the commencement of associated activities. While activities associated with the BMP are under way, inspect weekly during the rainy season and of two week intervals in the non-rainy season to verify continued BMP implementation.
- Inspect BMPs subject to non-storm water discharge daily while non-storm water discharges occur.
- Hazardous waste should be regularly collected.

- A foreman or construction supervisor should monitor onsite hazardous waste storage and disposal procedures.
- Waste storage areas should be kept clean, well organized, and equipped with ample cleanup supplies as appropriate for the materials being stored.
- Perimeter controls, containment structures, covers, and liners should be repaired or replaced as needed to maintain proper function.
- Hazardous spills should be cleaned up and reported in conformance with the applicable Material Safety Data Sheet (MSDS) and the instructions posted at the project site.
- The National Response Center, at (800) 424-8802, should be notified of spills of federal reportable quantities in conformance with the requirements in 40 CFR parts 110, 117, and 302.
- A copy of the hazardous waste manifests should be provided.

References

Blueprint for a Clean Bay: Best Management Practices to Prevent Stormwater Pollution from Construction Related Activities; Santa Clara Valley Nonpoint Source Pollution Control Program, 1995.

California Stormwater Quality Association (CASQA) Best Management Practices Handbook Construction, 2003.

Hawaii Administrative Rules, Title 4, Chapter 66, Pesticides.

Processes, Procedures and Methods to Control Pollution Resulting from All Construction Activity, 430/9-73-007, USEPA, 1973.

State of Hawaii Department of Business and Economic Development & Tourism
<http://www.hawaii.gov/dbedt>.

State of Hawaii Department of Health Office of Solid Waste Management Branch
<http://www.hawaii.gov/health/about/environmental/waste/SW/index.html>.

Stormwater Management for Construction Activities; Developing Pollution Prevention Plans and Best Management Practice, EPA 832-R-92005; USEPA, April 1992.

Stormwater Quality Handbooks - Construction Site Best Management Practices (BMPs) Manual, State of California Department of Transportation (Caltrans), November 2000.



Description and Purpose

Prevent or reduce the discharge of pollutants to storm water from contaminated soil and highly acidic or alkaline soils by conducting pre-construction surveys, inspecting excavations regularly, and remediating contaminated soil promptly.

Suitable Applications

Contaminated soil management is implemented on construction projects in highly urbanized or industrial areas where soil contamination may have occurred due to spills, illicit discharges, aerial deposition, past use and leaks from underground storage tanks.

Limitations

Contaminated soils that are hazardous and cannot be treated onsite must be disposed of offsite by a State of Hawaii Department of Health approved hazardous waste transporter. **NOTE:** If transporting petroleum-contaminated soil (PCS) loads off-site to other than permitted remediation facilities, use transporters approved by the DOH, Office of Solid Waste Management (OSWM). Any PCS loads to be taken to DOH-permitted remediation facilities must notify OSWM 48 hours prior (refer to Hawaii Revised Statutes). The presence of contaminated soil may indicate contaminated water as well. See NS-2, Dewatering Operations, for more information.

The procedures and practices presented in this BMP are general. The contractor should identify appropriate practices and procedures for the specific contaminants known to exist or discovered onsite.

Objectives

EC – Erosion Control	
SE – Sediment Control	
TR – Tracking Control	
WE – Wind Erosion Control	
NS – Non-Storm Water Management Control	
WM – Waste Management & Materials Pollution Control	√

Legend:

- √ Primary Objective
- ▲ Secondary Objective

Targeted Constituents

Sediment	
Nutrients	√
Trash	√
Metals	√
Bacteria	√
Oil and Grease	√
Organics	√

Potential Alternatives

None

Implementation

Most owners and developers conduct pre-construction environmental assessments as a matter of routine. Contaminated soils are often identified during project planning and development with known locations identified in the plans, specifications and in the site-specific BMPs plan. The contractor should review applicable reports and investigate appropriate call-outs in the plans, specifications, and site-specific BMPs plan. Recent court rulings holding contractors liable for cleanup costs when they unknowingly move contaminated soil highlight the need for contractors to confirm a site assessment is completed before earth moving begins.

The following steps will help reduce storm water and land pollution concerns resulting from contaminated soil:

- Conduct thorough, pre-construction inspections of the site and review documents related to the site. If inspection or reviews indicated presence of contaminated soils, develop a plan before starting work.
- Look for contaminated soil as evidenced by discoloration, odors, differences in soil properties, abandoned underground tanks or pipes, or buried debris.
- Prevent leaks and spills. Contaminated soil can be expensive to treat and dispose of properly. However, addressing the problem before construction is much less expensive than after the structures are in place.
- The contractor may further identify contaminated soils by investigating:
 - Past site uses and activities;
 - Detected or undetected spills and leaks;
 - Acid or alkaline solutions from exposed soil or rock formations high in acid or alkaline forming elements;
 - Contaminated soil as evidenced by discoloration, odors, differences in soil properties, abandoned underground tanks or pipes, or buried debris; and/or
 - Suspected soils should be tested at a certified laboratory.
- Determine if level of contamination is considered hazardous, as defined by the Hawaii Administrative Rules Title 11, Chapter 261 (HAR 11-261) Hazardous Waste Management Identification and Listing of Hazardous Waste; and DOH policy “Technical Guidance Manual for Underground Storage Tank Closure and Release Responses-Reporting, Remediation, and Management of Petroleum Contaminated Soil” dated January 4, 1996.
- If the soil is contaminated and hazardous, work with the State DOH Solid and Hazardous Waste Branch (586-4226) to develop options for treatment and/or disposal. Tier 1 action levels are found in HAR Title 11 Chapter 281 Underground Storage Tanks, DOH Environmental management Division Solid and Hazardous Waste Branch Policy Update “Technical Guidance Manual for Underground Storage Tank Closure and Release Responses-Reporting, Remediation, and Management of Petroleum Contaminated Soil” dated January 4, 1996.
- Secure required State DOH permits such as Transportation of Petroleum-contaminated Soil (PCS).

Education

- Have employees and subcontractors complete a safety training program which meets 29 CFR 1910.120 covering the potential hazards as identified, prior to performing any excavation work at the locations containing material classified as hazardous.
- Educate employees and subcontractors in identification of contaminated soil and on contaminated soil handling and disposal procedures.
- Hold regular meetings to discuss and reinforce disposal procedures (incorporate into regular safety meetings).

Handling Procedures for Material with Aerially Deposited Lead (ADL)

- Materials from areas designated as containing (ADL) may, if allowed by the contract special provisions, be excavated, transported, and used in the construction of embankments and/or backfill.
- Excavation, transportation, and placement operations should result in no visible dust.
- Caution should be exercised to prevent spillage of lead containing material during transport.
- Quality should be monitored during excavation of soils contaminated with lead.

Handling Procedures for Contaminated Soils

- Minimize onsite storage. Contaminated soil should be disposed of properly in accordance with all applicable regulations.
- Guidance documents by local government provide by the State of Hawaii Department of Health Solid and Hazardous Waste Branch, Underground Storage Tank Section.
- Test suspected soils at an approved certified laboratory.
- Work with the state regulatory agencies to develop options for treatment or disposal if the soil is contaminated.
- Avoid temporary stockpiling of contaminated soils or hazardous material.
- Take the following precautions if temporary stockpiling is necessary:
 - Cover the stockpile with plastic sheeting or tarps;
 - Install a berm around the stockpile to prevent runoff from leaving the area;
 - Do not stockpile in or near storm drains or watercourses; and
 - Remove contaminated material and hazardous material on exteriors of transport vehicles and place either into the current transport vehicle or into the excavation prior to the vehicle leaving the exclusion zone.
- Monitor the air quality continuously during excavation operations at all locations containing hazardous material.
- Procure all permits and licenses, pay all charges and fees, and give all notices necessary and incident to the due and lawful prosecution of the work, including registration for transporting vehicles carrying the contaminated material and the hazardous material.
- Collect water from decontamination procedures and treat or dispose of it at an appropriate disposal site.

- Collect non-reusable protective equipment, once used by any personnel, and dispose of at an appropriate disposal site.
- Install temporary security fence to surround and secure the exclusion zone. Remove fencing when no longer needed.
- Excavate, transport, and dispose of contaminated material and hazardous material in accordance with the rules and regulations of the following agencies (the specifications of these agencies supersede the procedures outlined in this BMP):
 - United States Department of Transportation (USDOT),
 - United States Environmental Protection Agency (USEPA),
 - State of Hawaii Department of Health Solid Waste and Hazardous Waste Branch,
 - State of Hawaii Department of Labor & Industrial Relations, and
 - Hawaii Occupational Safety and Health Administration (HIOSH).

Procedures for Underground Storage Tank Removals

- Refer to the Technical Guidance Manual for UST Close & Release Response, by the State of Hawaii Department of Health Solid and Hazardous Waste Branch, Underground Storage Tank Section.
- Prior to commencing tank removal operations, obtain the required underground storage tank removal permits and approval from the federal and state agencies that have jurisdiction over such work.
- To determine if it contains hazardous substances, arrange to have tested, any liquid or sludge found in the underground tank prior to its removal.
- Following the tank removal, take soil samples beneath the excavated tank and perform analysis as required by the state agency representative(s).
- The underground storage tank, any liquid or sludge found within the tank, and all contaminated substances and hazardous substances removed during the tank removal and transported to disposal facilities permitted to accept such waste.

Water Control

- All necessary precautions and preventive measures should be taken to prevent the flow of water, including ground water, from mixing with hazardous substances or underground storage tank excavations. Such preventative measures may consist of, but are not limited to, berms, cofferdams, grout curtains, freeze walls, and seal course concrete or any combination thereof.
- If water does enter an excavation and becomes contaminated, such water, when necessary to proceed with the work, should be discharged to clean, closed top, watertight transportable holding tanks, treated, and disposed of in accordance with federal and state laws.

Costs

Prevention of leaks and spills is inexpensive. Treatment or disposal of contaminated soil can be quite expensive.

Inspection and Maintenance

- Inspect and verify that activity-based BMPs are in place prior to the commencement of associated activities. While activities associated with the BMP are under way, inspect weekly during the rainy season and of two-week intervals in the non-rainy season to verify continued BMP implementation.
- Arrange for contractor's Water Pollution Control Manager, foreman, and/or construction supervisor to monitor onsite contaminated soil storage and disposal procedures.
- Monitor air quality continuously during excavation operations at all locations containing hazardous material.
- Coordinate contaminated soils and hazardous substances/waste management with the appropriate federal and state agencies.
- Implement WM-4, Spill Prevention and Control, to prevent leaks and spills as much as possible.

References

Blueprint for a Clean Bay: Best Management Practices to Prevent Stormwater Pollution from Construction Related Activities; Santa Clara Valley Nonpoint Source Pollution Control Program, 1995.

California Stormwater Quality Association (CASQA) Best Management Practices Handbook Construction, 2003.

Hawaii Administrative Rules, Title 11, Chapter 261, Hazardous Waste Management Identification and Listing of Hazardous Waste.

Hawaii Administrative Rules, Title 11, Chapter 281, Underground Storage Tanks.

Processes, Procedures and Methods to Control Pollution Resulting from All Construction Activity, 430/9-73-007, USEPA, 1973.

State of Hawaii Department of Health, Solid and Hazardous Waste Branch Policy Update "Technical Guidance Manual for Underground Storage Tank Closure and Release Responses-Reporting, Remediation, and Management of Petroleum-Contaminated Soil," 04 January, 1996.

State of Hawaii Department of Health, Solid and Hazardous Waste Branch Underground Storage Tank Section.

Stormwater Management for Construction Activities; Developing Pollution Prevention Plans and Best Management Practice, EPA 832-R-92005; USEPA, April 1992.

Stormwater Quality Handbooks - Construction Site Best Management Practices (BMPs) Manual, State of California Department of Transportation (Caltrans), November 2000.

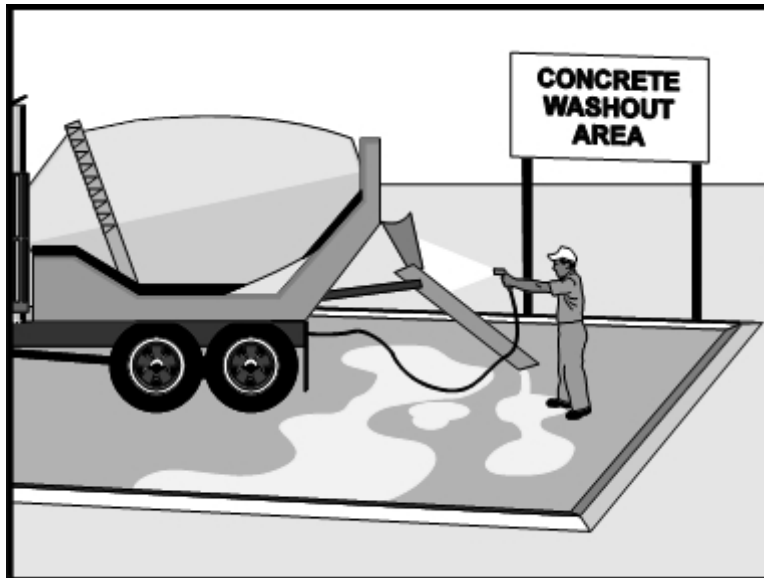

Description and Purpose

Prevent or reduce the discharge of pollutants to storm water from concrete waste by conducting washout offsite, performing onsite washout in a designated area, and training employee and subcontractors.

Suitable Applications

Concrete waste management procedures and practices are implemented on construction projects where:

- Concrete is used as a construction material or where concrete dust and debris result from demolition activities;
- Slurries containing portland cement concrete (PCC) or asphalt concrete (AC) are generated, such as from saw cutting, coring, grinding, grooving, and hydro-concrete demolition;
- Concrete trucks and other concrete-coated equipment are washed onsite;
- Mortar-mixing stations exist; and/or
- See also NS-8, Vehicle and Equipment Cleaning.

Limitations

Offsite washout of concrete wastes may not always be possible.

Objectives

- EC – Erosion Control
- SE – Sediment Control
- TR – Tracking Control
- WE – Wind Erosion Control
- NS – Non-Storm Water Management Control
- WM – Waste Management & Materials Pollution Control ✓

Legend:

- ✓ Primary Objective
- ▲ Secondary Objective

Targeted Constituents

- Sediment ✓
- Nutrients
- Trash
- Metals
- Bacteria ✓
- Oil and Grease
- Organics

Potential Alternatives

None

Implementation

The following steps will help reduce storm water pollution from concrete wastes:

- Discuss the concrete management techniques described in this BMP (such as handling of concrete waste and washout) with the ready-mix concrete supplier before any deliveries are made;
- Incorporate requirements for concrete waste management into material supplier and subcontractor agreements;
- Store dry and wet materials under cover, away from drainage areas;
- Avoid mixing excess amounts of fresh concrete;
- Perform washout of concrete trucks offsite or in designated areas only;
- Do not wash out concrete trucks into storm drains, open ditches, streets, or streams;
- Do not allow excess concrete to be dumped onsite, except in designated areas;
- For onsite washout:
 - Locate washout area at least 50 feet from storm drains, open ditches, or water bodies. Do not allow runoff from this area by constructing a temporary lined pit or bermed area large enough for liquid and solid waste; and
 - Wash out wastes into the temporary lined pit where the concrete can set, be broken up, and then disposed properly.
- Avoid creating runoff by draining water to a bermed or level area when washing concrete to remove fine particles and expose the aggregate; and
- Do not wash sweepings from exposed aggregate concrete into the street or storm drain. Collect and return sweepings to aggregate base stockpile or dispose in the trash.

Education

- Educate employees, subcontractors, and suppliers on the concrete waste management techniques described herein.
- Arrange for contractor's superintendent or representative to oversee and enforce concrete waste management procedures.

Concrete Slurry Wastes

- PCC and AC waste should not be allowed to enter storm drains or watercourses.
- PCC and AC waste should be collected and disposed of or placed in a temporary concrete washout facility.
- A sign should be installed adjacent to each temporary concrete washout facility to inform concrete equipment operators to utilize the proper facilities.
- Below grade concrete washout facilities are typical. Above grade facilities are used if excavation is not practical.
- A foreman or construction supervisor should monitor onsite concrete working tasks, such as saw cutting, coring, grinding and grooving to ensure proper methods are implemented.

- Saw-cut PCC slurry should not be allowed to enter storm drains or watercourses. Residue from grinding operations should be picked up by means of a vacuum attachment to the grinding machine. Saw cutting residue should not be allowed to flow across the pavement and should not be left on the surface of the pavement. See also NS-3, Paving and Grinding Operations; and WM-10, Liquid Waste Management.
- Slurry residue should be vacuumed and disposed in a temporary pit (as described in Onsite Temporary Concrete Washout Facility, Concrete Transit Truck Washout Procedures, below) and allowed to dry. Dispose of dry slurry residue in accordance with WM-5, Solid Waste Management.

Onsite Temporary Concrete Washout Facility, Transit Truck Washout Procedures

- Temporary concrete washout facilities should be located a minimum of 50 ft. from storm drain inlets, open drainage facilities, and watercourses. Each facility should be located away from construction traffic or access areas to prevent disturbance or tracking.
- A sign should be installed adjacent to each washout facility to inform concrete equipment operators to utilize the proper facilities.
- Temporary concrete washout facilities should be constructed above grade or below grade at the option of the contractor. Temporary concrete washout facilities should be constructed and maintained in sufficient quantity and size to contain all liquid and concrete waste generated by washout operations.
- Temporary washout facilities should have a temporary pit or bermed areas of sufficient volume to completely contain all liquid and waste concrete materials generated during washout procedures.
- Washout of concrete trucks should be performed in designated areas only.
- Only concrete from mixer truck chutes should be washed into concrete wash out.
- Concrete washout from concrete pumper bins can be washed into concrete pumper trucks and discharged into designated washout area or properly disposed of offsite.
- Once concrete wastes are washed into the designated area and allowed to harden, the concrete should be broken up, removed, and disposed of per WM-5, Solid Waste Management. Dispose of hardened concrete on a regular basis.
- Temporary Concrete Washout Facility (Type Above Grade):
 - Temporary concrete washout facility (type above grade) should be constructed as shown on the details at the end of this BMP, with a recommended minimum length and minimum width of 10 ft., but with sufficient quantity and volume to contain all liquid and concrete waste generated by washout operations; and
 - Plastic lining material should be a minimum of 10 mil in polyethylene sheeting and should be free of holes, tears, or other defects that compromise the impermeability of the material.
- Temporary Concrete Washout Facility (Type Below Grade):
 - Temporary concrete washout facilities (type below grade) should be constructed as shown on the details at the end of this BMP, with a recommended minimum length and minimum width of 10 ft. The quantity and volume should be sufficient to contain all liquid and concrete waste generated by washout operations;

- Lath and flagging should be commercial type; and
- Plastic lining material should be a minimum of 10 mil polyethylene sheeting and should be free of holes, tears, or other defects that compromise the impermeability of the material.

Removal of Temporary Concrete Washout Facilities

- When temporary concrete washout facilities are no longer required for the work, the hardened concrete should be removed and disposed of. Materials used to construct temporary concrete washout facilities should be removed from the site of the work and disposed of.
- Holes, depressions or other ground disturbance caused by the removal of the temporary concrete washout facilities should be backfilled and repaired.

Costs

All of the above are low cost measures.

Inspection and Maintenance

- Inspect and verify that activity-based BMPs are in place prior to the commencement of associated activities. While activities associated with the BMP are under way, inspect weekly during the rainy season and of two-week intervals in the non-rainy season to verify continued BMP implementation.
- Temporary concrete washout facilities should be maintained to provide adequate holding capacity with a minimum freeboard of 4 in. for above grade facilities and 12 in. for below grade facilities. Maintaining temporary concrete washout facilities should include removing and disposing of hardened concrete and returning the facilities to a functional condition. Hardened concrete materials should be removed and disposed of.
- Washout facilities must be cleaned, or new facilities must be constructed and ready for use once the washout is 75% full.

References

Blueprint for a Clean Bay: Best Management Practices to Prevent Stormwater Pollution from Construction Related Activities; Santa Clara Valley Nonpoint Source Pollution Control Program, 1995.

California Stormwater Quality Association (CASQA) Best Management Practices Handbook Construction, 2003.

Stormwater Management for Construction Activities; Developing Pollution Prevention Plans and Best Management Practice, EPA 832-R-92005; USEPA, April 1992.

Stormwater Quality Handbooks - Construction Site Best Management Practices (BMPs) Manual, State of California Department of Transportation (Caltrans), November 2000.

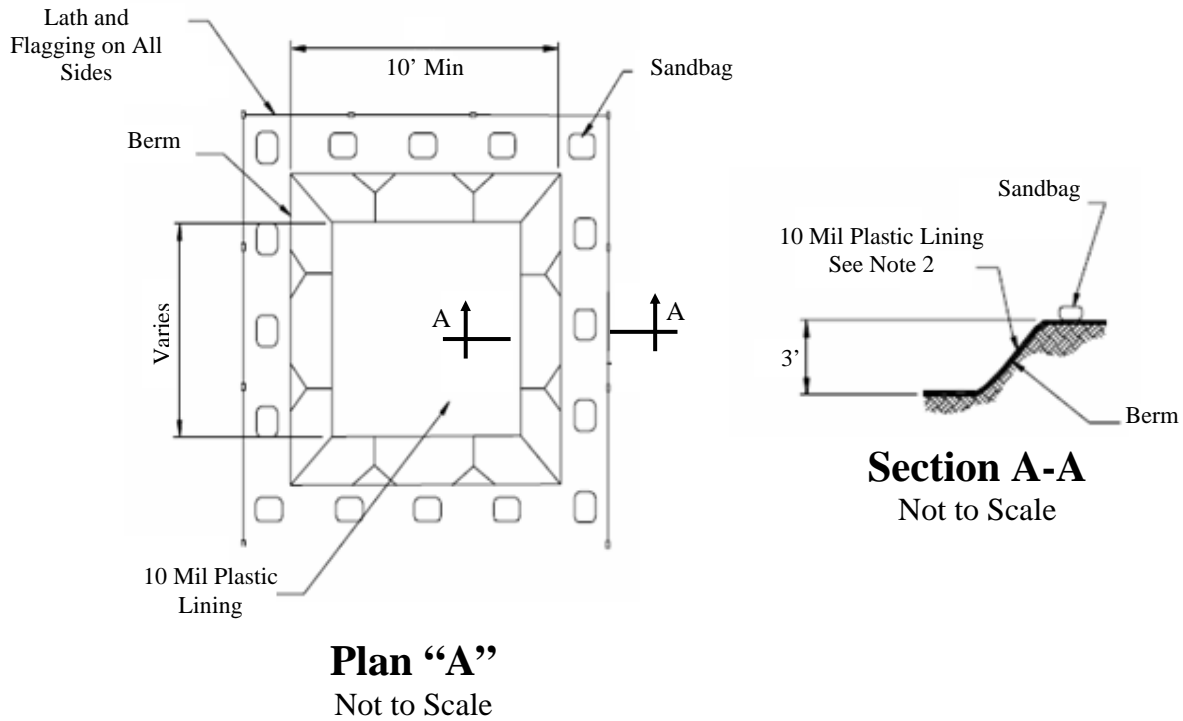

Notes:

1. Temporary concrete washout facility (Below Grade) should be constructed with a minimum length and width of 10 ft., but with sufficient quantity and volume to contain all liquid and concrete waste generated by washout operations.
2. Lath and flagging should be commercial type.
3. Plastic lining material should be a minimum of 10 mil polyethylene sheeting and should be free of holes, tears or other defects that compromise the impermeability of the material.

Below Grade Concrete Washout

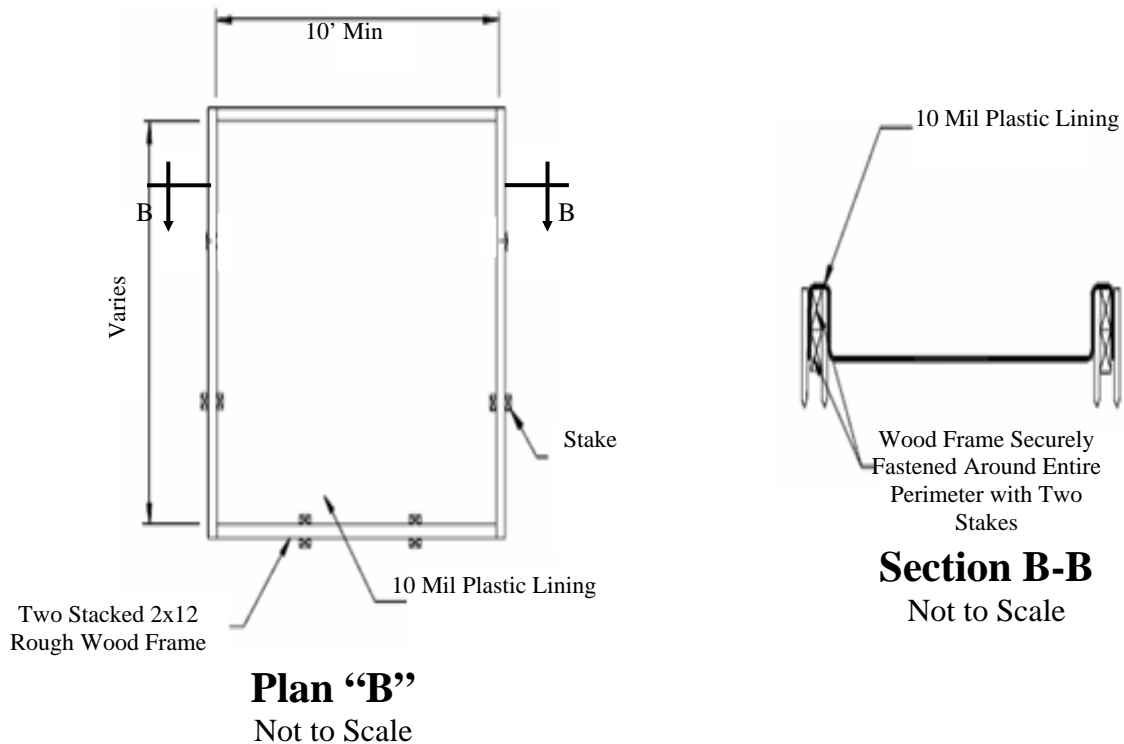

Notes:

1. Temporary concrete washout facility (Above Grade) should be constructed with a minimum length and width of 10 ft., but with sufficient quantity and volume to contain all liquid and concrete waste generated by washout operations.
2. Plastic lining material should be a minimum of 10 mil polyethylene sheeting and should be free of holes, tears or other defects that compromise the impermeability of the material.

Above Grade Concrete Washout

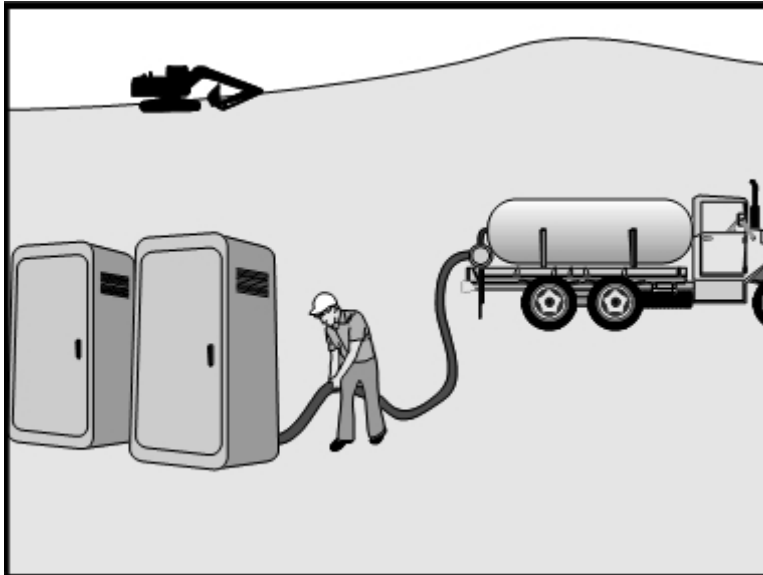

Description and Purpose

Proper sanitary and septic waste management prevent the discharge of pollutants to storm water from sanitary and septic waste by providing convenient, well-maintained facilities, and arranging for regular service and disposal.

Suitable Applications

Sanitary septic waste management practices are suitable for use at all construction sites that use temporary or portable sanitary and septic waste systems.

Limitations

None identified.

Implementation

Sanitary or septic wastes should be treated or disposed of in accordance with State and City requirements. In many cases, one contract with a local facility supplier will be all that it takes to make sure sanitary wastes are properly disposed.

Storage and Disposal Procedures

- Temporary sanitary facilities should be located away from drainage facilities, watercourses, and from traffic circulation. When subjected to high winds or risk of high winds, temporary sanitary facilities should be secured to prevent overturning.
- Wastewater should not be discharged or buried within the project site.
- Sanitary and septic systems that discharge directly into sanitary sewer systems, where permissible, should comply with the State of Hawaii

Objectives

- EC – Erosion Control
- SE – Sediment Control
- TR – Tracking Control
- WE – Wind Erosion Control
- NS – Non-Storm Water Management Control
- WM – Waste Management & Materials Pollution Control ✓

Legend:

- ✓ Primary Objective
- ▲ Secondary Objective

Targeted Constituents

- Sediment
- Nutrients ✓
- Trash ✓
- Metals
- Bacteria ✓
- Oil and Grease
- Organics ✓

Potential Alternatives

None

Department of Health Wastewater Branch, and City and County Department of Planning & Permitting requirements.

- Only reputable, professional sanitary and septic waste haulers should be used.
- Sanitary facilities should be located in a convenient location.
- Untreated raw wastewater should never be discharged or buried.
- If using an onsite disposal system (OSDS), such as a septic system, State of Hawaii Department of Health Wastewater Branch requirements must be followed.
- Temporary septic systems should treat wastes to appropriate levels before discharging.
- Temporary sanitary facilities that discharge to the sanitary sewer system should be properly connected to avoid illicit discharges.
- Sanitary and septic facilities should be maintained in good working order by a professional service.
- Regular waste collection by a professional hauler should be arranged before facilities overflow.

Education

- Educate employees, subcontractors, and suppliers on sanitary and septic waste storage and disposal procedures.
- Educate employees, subcontractors, and suppliers of potential dangers to humans and the environment from sanitary and septic wastes.
- Instruct employees, subcontractors, and suppliers in identification of sanitary and septic waste.
- Hold regular meetings to discuss and reinforce disposal procedures (incorporate into regular safety meetings).
- Establish a continuing education program to indoctrinate new employees.

Costs

All of the above are low cost measures.

Inspection and Maintenance

- Inspect and verify that activity-based BMPs are in place prior to the commencement of associated activities. While activities associated with the BMP are under way, inspect weekly during the rainy season and of two-week intervals in the non-rainy season to verify continued BMP implementation.
- Arrange for regular waste collection.
- If high winds are expected, portable sanitary facilities must be secured with spikes or weighed down to prevent over turning.

References

California Stormwater Quality Association (CASQA) Best Management Practices Handbook Construction, 2003.

Stormwater Management for Construction Activities; Developing Pollution Prevention Plans and Best Management Practice, EPA 832-R-92005; USEPA, April 1992.

Stormwater Quality Handbooks - Construction Site Best Management Practices (BMPs) Manual, State of California Department of Transportation (Caltrans), November 2000.

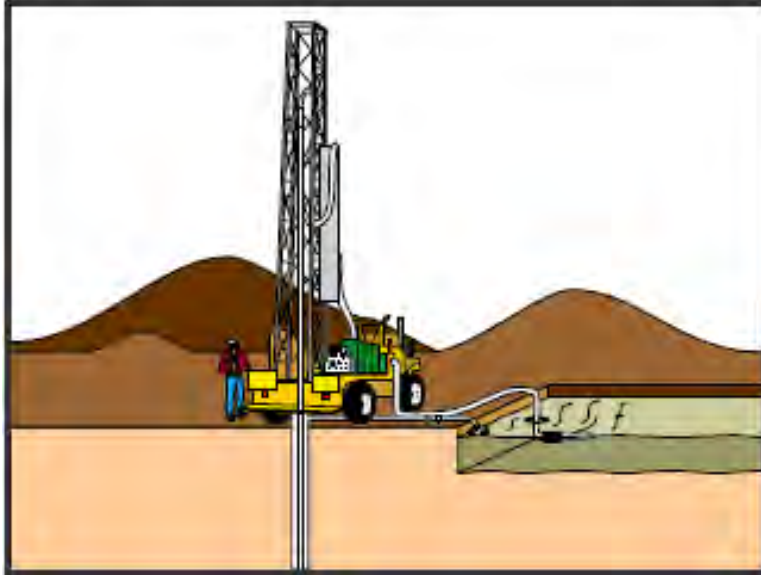

Description and Purpose

Liquid waste management includes procedures and practices to prevent discharge of pollutants to the storm drain system or to watercourses as a result of the creation, collection, and disposal of non-hazardous liquid wastes.

Suitable Applications

Liquid waste management is applicable to construction projects that generate any of the following non-hazardous by-products, residuals, or wastes:

- Drilling slurries and drilling fluids;
- Grease-free and oil-free wastewater and rinse water;
- Dredgings; and/or
- Other non-storm water liquid discharges not permitted by separate permits.

Limitations

- Disposal of some liquid wastes may be subject to specific laws and regulations or to requirements of other permits secured for the construction project (e.g. State of Hawaii Department of Health Clean Water Branch, NPDES permits, State of Hawaii Department of Health Safe Drinking Water Branch Underground Injection Control Class V, Subclass D, Army Corps permits, etc.).
- Liquid waste management does not apply to dewatering operations (NS-2 Dewatering Operations), solid waste management (WM-5 Solid Waste Management), hazardous wastes (WM-6 Hazardous Waste Management), or concrete slurry residue (WM-8 Concrete Waste Management).

Objectives

- EC – Erosion Control
- SE – Sediment Control
- TR – Tracking Control
- WE – Wind Erosion Control
- NS – Non-Storm Water Management Control
- WM – Waste Management & Materials Pollution Control ✓

Legend:

- ✓ Primary Objective
- ▲ Secondary Objective

Targeted Constituents

- Sediment ✓
- Nutrients ✓
- Trash ✓
- Metals ✓
- Bacteria
- Oil and Grease ✓
- Organics

Potential Alternatives

None

- Typical permitted non-storm water discharges can include: water line flushing; landscape irrigation; diverted stream flows; rising ground waters; uncontaminated pumped ground water; discharges from potable water sources; foundation drains; irrigation water; springs; water from crawl space pumps; footing drains; lawn watering; flows from riparian habitats and wetlands; and discharges or flows from emergency fire fighting activities.

Implementation

General Practices

- Instruct employees and subcontractors how to safely differentiate between non-hazardous liquid waste and potential or known hazardous liquid waste.
- Instruct employees, subcontractors, and suppliers that it is unacceptable for any liquid waste to enter any storm drainage device, waterway, or receiving water.
- Educate employees and subcontractors on liquid waste generating activities and liquid waste storage and disposal procedures.
- Hold regular meetings to discuss and reinforce disposal procedures (incorporate into regular safety meetings).
- Verify which non-storm water discharges are permitted by the statewide NPDES permit; different regions might have different requirements not outlined in this permit.
- Apply NS-8 Vehicle and Equipment Cleaning for managing wash water and rinse water from vehicle and equipment cleaning operations.

Containing Liquid Wastes

- Drilling residue and drilling fluids should not be allowed to enter storm drains and watercourses and should be disposed of.
- If an appropriate location is available, drilling residue and drilling fluids that are exempt may be dried by infiltration and evaporation in a containment facility constructed in conformance with the provisions concerning the Temporary Concrete Washout Facilities detailed in WM-8 Concrete Waste Management.
- Liquid wastes generated as part of an operational procedure, such as water-laden dredged material and drilling mud, should be contained and not allowed to flow into drainage channels or receiving waters prior to treatment.
- Liquid wastes should be contained in a controlled area such as a holding pit, sediment basin, roll-off bin, or portable tank.
- Containment devices must be structurally sound and leak free. Washout/liquid waste storage/treatment facilities shall prevent the infiltration of contaminants which may affect subsurface soils and groundwater.
- Containment devices must be of sufficient quantity or volume to completely contain the liquid wastes generated.
- Precautions should be taken to avoid spills or accidental releases of contained liquid wastes. Apply the education measures and spill response procedures outlined in WM-4 Spill Prevention and Control.
- Containment areas or devices should not be located where accidental release of the contained liquid can threaten health or safety or discharge to water bodies, channels, or storm drains.

Capturing Liquid Wastes

- Capture all liquid wastes that have the potential to affect the storm drainage system (such as wash water and rinse water from cleaning walls or pavement), before they run off a surface.
- Do not allow liquid wastes to flow or discharge uncontrolled. Use temporary dikes or berms to intercept flows and direct them to a containment area or device for capture.
- Use a sediment trap (SE-3 Sediment Trap) for capturing and treating sediment laden liquid waste or capture in a containment device and allow sediment to settle.

Disposing of Liquid Wastes

- A typical method to handle liquid waste is to dewater the contained liquid waste, using procedures such as described in NS-2 Dewatering Operations, and SE-2 Sediment Basin, and dispose of resulting solids per WM-5 Solid Waste Management.
- Methods of disposal for some liquid wastes may be prescribed in Water Quality Reports, NPDES permits, Environmental Impact Reports, 401 or 404 permits, and City discharge permits, etc. Review the site-specific BMPs plan to see if disposal methods are identified.
- Liquid wastes, such as from dredged material, may require testing and certification whether it is hazardous or not before a disposal method can be determined.
- For disposal of hazardous waste, see WM-6 Hazardous Waste Management.
- If necessary, further treat liquid wastes prior to disposal. Treatment may include, though is not limited to, sedimentation, filtration, and chemical neutralization.

Costs

Prevention costs for liquid waste management are minimal. Costs increase if cleanup or fines are involved.

Inspection and Maintenance

- Inspect and verify that activity-based BMPs are in place prior to the commencement of associated activities. While activities associated with the BMP are under way, inspect weekly during the rainy season and of two-week intervals in the non-rainy season to verify continued BMP implementation.
- Inspect BMPs subject to non-storm water discharge daily while non-storm water discharges occur.
- Remove deposited solids in containment areas and capturing devices as needed and at the completion of the task. Dispose of any solids as described in WM-5 Solid Waste Management.
- Inspect containment areas and capturing devices and repair as needed.

References

California Stormwater Quality Association (CASQA) Best Management Practices Handbook Construction, 2003.

Stormwater Quality Handbooks - Construction Site Best Management Practices (BMPs) Manual, State of California Department of Transportation (Caltrans), November 2000.

SECTION 5: GLOSSARY

303(d) Listed: Water bodies listed as impaired as per Section 303(d) of the 1972 Clean Water Act.

Best Management Practices (BMPs): Includes schedules of activities, prohibitions of practices, maintenance procedures, and other management practices to prevent, eliminate, or reduce the pollution of waters of the receiving waters. BMPs also include treatment requirements, operating procedures, and practices to control plant site runoff spillage or leaks, sludge or waste disposal, or drainage from raw material storage.

Catch Basin (Also known as Inlet): Box-like underground concrete structure with openings in curbs and gutters designed to collect runoff from streets and pavement.

City: City and County of Honolulu

Clean Water Act (CWA): (33 U.S.C. 1251 et seq.) requirements of the NPDES program are defined under Sections 307, 402, 318 and 405 of the CWA.

Construction Activity: Includes clearing, grading, excavation, and contractor activities that result in soil disturbance. Construction activities are regulated by the NPDES General Permit Coverage Hawaii Administrative Rules (HAR) Chapter 11-55 Water Pollution Control, Appendix C-Storm Water Associated with Construction Activities, effective October 22, 2007.

Construction General Permit: A National Pollutant Discharge Elimination System (NPDES) Notice of General Permit Coverage (NGPC) permit is issued by the State of Hawaii Department of Health Clean Water Branch for the discharge of storm water associated with construction activity from soil disturbance of one acre or more. Reference HAR Chapter 11-55 Water Pollution Control Appendix A Standard General Permit Conditions, Appendix C Discharges of Storm Water Associated with Construction Activities.

Denuded: Land stripped of vegetation or land that has had its vegetation worn down due to the impacts from the elements or humans.

Detention: The capture and subsequent release of storm water runoff from the site at a slower rate than it is collected, the difference being held in temporary storage.

Discharge: A release or flow of storm water or other substance from a conveyance system or storage container. Broader – includes release to storm drains, etc.

Effluent Limits: Limitations on amounts of pollutants that may be contained in a discharge. Can be expressed in a number of ways including as a concentration, as a concentration over a time period (e.g., 30-day average must be less than 20 mg/l), or as a total mass per time unit, or as a narrative limit.

Erosion: The wearing away of land surface by wind or water. Erosion occurs naturally from weather or runoff but can be intensified by land-clearing practices related to farming, new development, redevelopment, road building, or timber cutting.

Facility: Is a collection of industrial or construction processes discharging storm water associated with industrial activity within the property boundary or operational unit.

Grading: The cutting or filling of the land surface to a desired slope or elevation.

Hazardous Waste: A waste or combination of wastes that, because of its quantity, concentration, or physical, chemical or infectious characteristics, may either cause or significantly contribute to an increase in mortality or an increase in serious irreversible illness; or pose a substantial present or potential hazard to human health or the environment when improperly treated, stored, transported, disposed of or otherwise managed. Possesses at least one of four characteristics (ignitability, corrosivity, reactivity, or toxicity) or appears on special EPA or state lists. Regulated under the federal Resource Conservation and Recovery Act and the California Health and Safety Code.

Illicit Discharges: Any discharge to a municipal separate storm sewer that is not in compliance with applicable laws and regulations as discussed in this document.

Industrial General Permit: A National Pollutant Discharge Elimination System (NPDES) Permit issued by the State of Hawaii Department of Health Clean Water Branch Board for discharge of storm water associated with industrial activity.

Inlet: An entrance into a ditch, storm drain, or other waterway.

Integrated Pest Management (IPM): An ecosystem-based strategy that focuses on long-term prevention of pests or their damage through a combination of techniques such as biological control, habitat manipulation, modification of cultural practices, and use of resistant varieties. Pesticides are used only after monitoring indicates they are needed according to established guidelines, and treatments are made with the goal of removing only the target organism.

Maximum Extent Practicable (MEP): Economically achievable measures for the control of the addition of pollutants from existing and new categories and classes of nonpoint sources of pollution, which reflect the greatest degree of pollutant reduction achievable through the application of the best available nonpoint source pollution control practices, technologies, processes, siting criteria, operating methods or other alternatives.

Municipal Separate Storm Sewer System (MS4): A conveyance or system of conveyances (including roads with drainage systems, municipal streets, catch basins, curbs, gutters, ditches, man-made channels, or storm drains): (i) designed or used for collecting or conveying storm water; (ii) which is not a combined sewer; and (iii) which is not part of a Publicly Owned Treatment Works (POTW) as defined at Title 40 of the Code of Federal Regulations (CFR) 122.2. A “Small MS4” is defined as an MS4 that is not a permitted MS4 under the Phase I regulations. This definition of a Small MS4 applies to MS4 operated within cities and counties as well as governmental facilities that have a system of storm sewers.

Non-Storm Water Discharge: Any discharge to municipal separate storm sewer that is not composed entirely of storm water.

Nonpoint Source Pollution: Pollution that does not come from a point source. Nonpoint source pollution originates from aerial diffuse sources that are mostly related to land use.

Notice of Intent (NOI): A formal notice to the State of Hawaii Clean Water Branch submitted by the owner of an industrial site or construction site that said owner seeks coverage under a General Permit for discharges associated with industrial and construction activities. The NOI provides information on the owner, location, type of project, and certifies that the owner will comply with the conditions of the construction General Permit.

Notice of Cessation (NOC): Formal notice to the State of Hawaii Clean Water Branch submitted by owner/ developer that a construction project is complete.

NPDES Permit: NPDES is an acronym for National Pollutant Discharge Elimination System. NPDES is the national program for administering and regulating Sections 307, 318, 402, and 405 of the Clean Water Act (CWA). In Hawaii, the Department of Health Clean Water Branch has issued a permit to discharge storm water runoff from the City and County of Honolulu's Municipal Separate Storm Sewer System (MS4) into state waters in and around the Island of Oahu for storm water discharges.

Outfall: The end point where storm drains discharge water into a waterway.

Point Source: Any discernible, confined, and discrete conveyance from which pollutants are or may be discharged. This term does not include return flows from irrigated agriculture or agricultural storm water runoff.

Pollutant: Generally, any substance introduced into the environment that adversely affects the usefulness of a resource.

Pollution Prevention (P2): Practices and actions that reduce or eliminate the generation of pollutants.

Precipitation: Any form of rain or snow.

Pretreatment: Treatment of waste stream before it is discharged to a collection system.

Reclaim (water reclamation): Planned use of treated effluent that would otherwise be discharged without being put to direct use.

Retention: The storage of storm water to prevent it from leaving the development site.

Reuse (water reuse): (see Reclaim)

Runoff: Water originating from rainfall, melted snow, and other sources (e.g., sprinkler irrigation) that flows over the land surface to drainage facilities, rivers, streams, springs, seeps, ponds, lakes, and wetlands.

Run-on: Offsite storm water surface flow or other surface flow which enters your site.

Scour: The erosive and digging action in a watercourse caused by flowing water.

Secondary Containment: Structures, usually dikes or berms, surrounding tanks or other storage containers, designed to catch spilled materials from the storage containers.

Sedimentation: The process of depositing soil particles, clays, sands, or other sediments that were picked up by runoff.

Sediments: Soil, sand, and minerals washed from land into water, usually after rain, that collect in reservoirs, rivers, and harbors, destroying fish nesting areas and clouding the water, thus preventing sunlight from reaching aquatic plants. Farming, mining, and building activities without proper implementation of BMPs will expose sediment materials, allowing them to be washed off the land after rainfalls.

Significant Materials: Includes, but not limited to, raw materials; fuels; materials such as solvents, detergents, and plastic pellets; finished materials such as metallic products; raw materials used in food processing or production; hazardous substances designed under Section 101(14) of CERCLA; any chemical the facility is required to report pursuant to Section 313 of Title III of SARA; fertilizers; pesticides; and waste products such as ashes, slag, and sludge that have the potential to be released with storm water discharges.

Significant Quantities: The volume, concentrations, or mass of a pollutant in storm water discharge that can cause or threaten to cause pollution, contamination, or nuisance that adversely impact human health or the environment and cause or contribute to a violation of any applicable water quality standards for receiving water.

Source Control BMPs: Operational practices that reduce potential pollutants at the source.

Source Reduction (also source control): The technique of stopping and/ or reducing pollutants at their point of generation so that they do not come into contact with storm water.

Storm Drains: Above- and below-ground structures for transporting storm water to streams or outfalls for flood control purposes.

Storm Water: Defined as urban runoff and snowmelt runoff consisting only of those discharges, which originate from precipitation events. Storm water is that portion of precipitation that flows across a surface to the storm drain system or receiving waters.

Storm Water Discharge Associated with Industrial Activity: Discharge from any conveyance which is used for collecting and conveying storm water from an area that is directly related to manufacturing, processing, or raw materials storage activities at an industrial plant.

Storm Water Pollution Control Plan (SWPCP): A written plan that documents the series of phases and activities that, first, characterizes your site, and then prompts you to select and carry out actions which prevent the pollution of storm water discharges. For construction activities NOI, the Department of Health Clean Water Branch has renamed SWPCP to site-specific construction BMPs plan.

Treatment Control BMPs: Treatment methods to remove pollutants from storm water.

Toxicity: Adverse responses of organisms to chemicals or physical agents ranging from mortality to physiological responses such as impaired reproduction or growth anomalies.

Turbidity: Describes the ability of light to pass through water. The cloudy appearance of water caused by suspended and colloidal matter (particles).